

CITY OF TONTITOWN, ARKANSAS
DRAINAGE CRITERIA MANUAL

September, 2005

TABLE OF CONTENTS

Section 1	Submittal Procedures
Section 2	Determination of Storm Runoff
Section 3	Flow in Storm Drains and Drainage Appurtenances
Section 4	Culvert Hydraulics
Section 5	Stormwater Detention
Section 6	Flow in Streets
Section 7	Storm Drain Inlets
Section 8	Storm Sewer System Design
Section 9	Open Channel Flow
Section 10	Erosion and Sediment Control

TABLE OF CONTENTS - SECTION 1

SECTION 1 - SUBMITTAL PROCEDURES

- 1.1 Definitions
- 1.2 General
 - 1.2.1 Conceptual Stormwater Management and Drainage Plan
 - 1.2.2 Preliminary Stormwater Management and Drainage Plan
 - 1.2.3 Final Stormwater Management and Drainage Plan
- 1.3 Drainage Report
- 1.4 Plans and Specifications
 - 1.4.1 Title Sheet
 - 1.4.2 General Layout Sheet
 - 1.4.3 Other Requirements

SECTION I - SUBMITTAL PROCEDURES

1.1 DEFINITIONS

Unless specifically defined below, words or phrases shall be interpreted so as to give them the meaning they have in common usage and consistent with the words and phrases used in the Subdivision Regulations and stormwater management programs (e.g., Federal Emergency Management Agency [FEMA], Arkansas Department of Environmental Quality, and Arkansas State Highways and Transportation Department [AHTD]) and to give this Drainage Criteria Manual its most effective application. Words used in the singular shall include the plural, and the plural the singular; words used in the present tense shall include the future tense. The word "shall" connotes mandatory and not discretionary; the word "may" is permissive.

ABRASION - Wear or scour by hydraulic traffic.

ABSORPTION - The assimilation or taking up of water by soil.

ADEQ – Arkansas Department of Environmental Quality, or its successors.

AGGRADATION - General and progressive raising of the streambed by deposition of sediment.

AHTD - Arkansas State Highway and Transportation Department.

ALLUVIAL - Referring to deposits of silts, sands, gravels and similar detritus material, which have been transported by running water.

ANTECEDENT MOISTURE - The degree of wetness of the soil at the beginning of a runoff period; frequently expressed as an index determined by summation of weighted daily rainfalls for a period preceding the runoff in question.

BACKWATER - The rise in water surface measured at a specified location upstream from the constriction causing the increased height.

BASE FLOOD - The flood or tide having a 1 percent chance of being exceeded in any given year (commonly known as a 100-year flood).

BASE FLOODPLAIN - The area subject to flooding by the base flood.

BED LOAD - Sediment that moves by rolling, sliding, or skipping along the bed and is essentially in contact with the streambed.

BRAIDED STREAM - A stream in which flow is divided at normal stage by small islands. This type of stream has the aspect of a single large channel within which there are subordinate channels.

BUOYANCY - The power of supporting a floating body, including the tendency to float an empty pipe (by exterior hydraulic pressure).

CAPILLARY RISE - The height above a free water elevation to which water will rise by capillary action.

CAPILLARY SUCTION - Capillary force that pulls or draws water against the force of gravity in dry soils.

CAISSON - Watertight box or cylinder used in excavating for foundations or tunnel pits - to hold out water so concreting or other construction can be carried on.

CITY - The City of Tontitown, Arkansas, and its employees expressly authorized by the Mayor to accomplish the specified task.

CITY ENGINEER – The registered professional engineer designated as the “City Engineer” by the City Council of the City of Tontitown, Arkansas; whether a staff employee of the City or a consulting civil engineer.

COFFERDAM - A barrier built in the water so as to form an enclosure from which the water is pumped to permit free access to the areas within.

COMPOSITE HYDROGRAPH - A plot of mean daily discharges for a number of years of record on a single year time base for the purpose of showing the occurrence of high and low flows.

CONDUIT - A pipe of other opening, buried or above ground for conveying hydraulic traffic, pipelines, cables or other utilities.

CONFLUENCE - A junction of streams.

CONTRACTION - The reduction in cross sectional area of flow.

CONTRACTOR - The licensed contracting company hired by the Developer/Owner to construct the improvements.

CONTROL - A section or reach of an open conduit or stream channel that maintains a stable relationship between stage and discharge.

CONVEYANCE - A measure of the water carrying capacity of a stream or channel.

CRITICAL FLOW - That flow in open channels at which the energy content of the fluid is at a minimum. Also, that flow which has a Froude number of one.

CULVERT - A conduit for conveying water through an embankment.

CURRENT METER - An instrument for measuring the velocity of a current. It is usually operated by a wheel equipped with vanes or cups, which is rotated by the action of the impinging current. An indicating or recording device is provided to indicate the speed of rotation that is correlated with the velocity of the current.

DEBRIS - Any material including floating woody materials and other trash, suspended sediment, or bed load, moved by a flowing stream.

DEFLECTION - Change in shape or decrease in diameter of a conduit, produced without fracture of the material.

DEGRADATION - General and progressive lowering of the longitudinal profile of a channel by erosion.

DESIGN FLOOD - The peak discharge, volume if appropriate, stage or wave crest elevation of the flood associated with the probability of exceedance selected for the design of a roadway encroachment. By definition, the roadway will not be inundated from the stage of the design flood.

DETENTION - The slowing, dampening, or attenuating of flows either entering the sewer system or surface drainage by temporarily holding the water on a surface area, in a storage basin, or within the sewer.

DETENTION BASIN POND - An open excavation or depression in the ground surface used for temporary storage of storm water prior to release downstream.

DETENTION TANK - A tank used to temporarily store storm water underground. Inlet and outlet flow controls are usually provided and tank can be perforated to exfiltrate water into soil during the detention time.

DEVELOPER - The person, firm, partnership, corporation or other entity planning, constructing, altering or reconstructing a public street. The developer may or may not also be the Owner of the property in question.

DEVELOPMENT - Any improvements to a parcel of land other than the construction of a single-family dwelling or a duplex.

DIAPHRAGM - A metal collar at right angles to a drainpipe for the purpose of retarding seepage or the burrowing of rodents.

DIKE - An embankment to confine or control water, especially one built along the banks of a river to prevent overflow of low lands or to deflect water away from a bank. Also called Levee.

DIKE, FINGER - Relatively short embankments constructed normal to a larger embankment, such as an approach fill to a bridge. Their purpose is to impede flow and direct it away from the major embankment.

DIKE, SPUR - Relatively short embankments constructed at the upstream side of a bridge end for the purpose of aligning flow with the waterway opening and to move scour away from the bridge abutment.

DIKE, TOE - Embankments constructed to prevent lateral flow from scouring the corner of the downstream side of an abutment embankment. Sometimes referred to as training dikes.

DIKE, TRAINING - Embankments constructed to provide a transition from the natural stream channel or floodplain, both to and from a constricting bridge crossing.

DRAWDOWN - The difference in elevation between the water surface elevation at a constriction in a stream or conduit and the elevation that would exist if the constriction were absent. Drawdown also occurs at changes from mild to steep channel slopes and at weirs or vertical spillways.

DYNAMIC EQUILIBRIUM - That delicate balance of the many factors that must occur in a stream reach so that the channel is neither aggrading nor degrading.

ENCROACHMENT - Extending beyond the original, or customary limits, such as by occupancy of the river and/or floodplain by earth fill embankment. An action within the limits of the base floodplain.

ENERGY GRADE LINE - The line that represents the total energy gradient along the channel. It is established by adding together the potential energy expressed as the water surface elevation referenced to a datum and the kinetic energy (usually expressed as velocity head) at points along the flowing water.

ENERGY HEAD - The elevation of the hydraulic gradient at any section, plus the velocity head.

ENGINEER OF RECORD - The Arkansas Registered Professional Engineer responsible for the design of the improvements, usually engaged by the Developer.

EQUALIZER - A culvert placed where there is no channel but where it is desirable to have standing water at equal elevations on both sides of a fill.

FLOOD FREQUENCY - Also referred to as exceedance interval, recurrence interval or return period; the average time interval between actual occurrences of a hydrological event of a given or greater magnitude; the percent chance of occurrence is the reciprocal of flood frequency, e.g., a 2 percent chance flood is the reciprocal statement of a 50-year flood.

FLOODPLAIN - Normally dry land areas subject to periodic temporary inundation by stream flow or tidal overflow. Land formed by deposition of sediment by water; alluvial land.

FLOODPROOF - To design and construct individual buildings, facilities, and their sites to protect against structural failure, to keep water out or to reduce the effects of water entry.

FLOW, CRITICAL - That flow in open channels at which the energy content of the fluid is at a minimum. Also, that flow which has a Froude number of one.

FLOW, SUBCRITICAL - In this state, gravity forces are dominant, so that the flow has a low velocity and is often described as tranquil and streaming. Also, that flow which has a Froude number less than one.

FLOW, SUPERCRITICAL - In this state, inertia forces are dominant, so that flow has a high velocity and is usually described as rapid, shooting and torrential. Also, that flow which has a Froude number greater than one.

FLOW REGIME. The system or order characteristic of stream flow with respect to velocity, depth and specific energy.

FLUME - An open channel or conduit of metal, concrete or wood, on a prepared grade, trestle or bridge.

FORD - A shallow place where a stream may be crossed by traffic.

FREEBOARD - The vertical clearance of the lowest structural member of the bridge superstructure above the water surface elevation of the overtopping flood; the vertical distance between the level of the water surface usually corresponding to the design flow and a point of interest such as a levee top or specific location on the roadway grade.

FREE OUTLET - (as pertaining to critical flow) - Exists when the backwater does not diminish the discharge of a conduit.

FRENCH DRAIN - An underground passageway for water through interstices among stones placed loosely in a trench.

FROUDE NUMBER - A dimensionless expression of the ratio of inertia forces to gravity forces, used as an index to characterize the type of flow in a hydraulic structure in which gravity is the force producing motion and inertia is the resisting force. It is equal to a characteristic flow velocity (mean, surface, or maximum) of the system divided by the square root of the product of a characteristic dimension (as diameter or depth) and the gravity constant (acceleration due to gravity) all expressed in consistent units. $F_r = \frac{V}{(gy)^{0.5}}$

GAGING STATION - A location on a stream where measurements of stage or discharge are customarily made. The location includes a reach of channel through which the flow is uniform, a control downstream from this reach and usually a small building to house the recording instruments.

GRADUALLY VARIED FLOW - In this type of flow, changes in depth and velocity take place slowly over large distances, resistance to flow dominates and acceleration forces are neglected.

GROUNDWATER - Subsurface water occupying the saturation zone, from which wells and springs are fed. In a strict sense the term applies only to water below the water table.

GROUNDWATER RECHARGE - Water descending to the zone of saturation from the atmosphere which gravitates to the zone of saturation under natural conditions or which is added to the zone of saturation by infiltration of storm water using subsurface disposal systems as defined herein.

GROUNDWATER TABLE - (or level) - Upper surface of the zone of saturation in permeable rock or soil. (When the upper surface is confined by impermeable rock, the water table is absent.)

HEAD - The energy, either kinetic or potential, possessed by each unit weight of a liquid expressed as the vertical height through which a unit weight would have to fall to release the average energy possessed.

HYDRAULIC RADIUS - The cross-sectional area of a stream of water divided by the length of that part of its periphery in contact with its containing conduits; the ratio of area to wetted perimeter.

HYDROGRAPH - A graph of stage or discharge versus time.

IMPERVIOUS - Not allowing, or allowing only with great difficulty, the movement of water; impermeable. Completely resisting entrance of fluids.

INFILTRATION - The passage of water through the soil surface into the ground. Normally used interchangeably with the word percolation.

INLET TIME - The time required for storm runoff to flow from the most remote point of a drainage area to the point where it enters a drain or culvert.

INUNDATE - To cover or fill as with a flood.

INVERT - That part of a pipe or sewer below the spring line - generally the lowest point of the internal cross section.

MEANDER - In connection with streams, a winding channel usually in an erodible, alluvial valley. A reverse of S-shaped curve or series of curves formed by erosion of the concave bank, especially at the downstream end, characterized by curved flow and alternating shoals and bank erosion. Meandering is a stage in the migratory movement of the channel as a whole down the valley.

NATURAL AND BENEFICIAL FLOODPLAIN VALUES - Include but are not limited to fish, wildlife, plants, open space, natural beauty, scientific study, outdoor recreation, agriculture, aquaculture, forestry, natural moderation of floods, water quality maintenance, and groundwater recharge.

NAVD 88 – The North American Vertical Datum of 1988, a standard for measuring elevations referenced to sea level.

NONUNIFORM FLOW - A flow in which the velocities vary from point to point along the stream or conduit, due to variations in cross section, slope, etc.

NORMAL WATER SURFACE (NATURAL WATER SURFACE) - The free surface associated with flow in natural streams.

NORTH AMERICAN VERTICAL DATUM of 1988 shall mean NAVD 88 for vertical control data based on the mass or density of the Earth instead of the varying values of the heights of the seas used to establish the NGVD.

OPEN CHANNEL - Any conveyance in which water flows with a free surface.

OUTFALL (or outlet) - In hydraulics, the discharge end of drains and sewers.

OVERTOPPING FLOOD - The flood described by the probability of exceedance and water surface elevation at which flow occurs over the roadway, over the watershed divide, or through structure(s) provided for emergency relief.

PERIPHERY - Circumference or perimeter of a circle, ellipse, pipe arch, or other closed curvilinear figure.

PERMEABILITY - The property of a material that permits appreciable movement of water through it when it is saturated and movement is actuated by hydrostatic pressure of the magnitude normally encountered in natural subsurface water.

PERVIOUS SOIL - Soil containing voids through which water will move under ordinary hydrostatic pressure.

PONDING - Refers to water backed up in a channel or ditch as the result of a culvert of inadequate capacity or design to permit the water to flow unrestricted.

PRACTICABLE - Capable of being done within reasonable natural, social, or economic constraints.

PRESERVE - To avoid modification to the functions of the natural floodplain environment or to maintain it as closely as practicable in its natural state.

RAINFALL INTENSITY - Amount of rainfall occurring in a unit of time, converted to its equivalent in inches per hour at the same rate.

RAPIDLY VARIED FLOW - In this type of flow, changes in depth and velocity take place over short distances, acceleration forces dominate, and energy loss due to friction is minor.

REACH - A length of stream channel.

RECHARGE - Addition of water to the zone of saturation from precipitation or infiltration.

RECHARGE BASIN - A basin excavated in the earth to receive the discharge from streams or storm drains for the purpose of replenishing groundwater supply.

REGIME - The system or order characteristic of a stream; its behavior with respect to velocity and volume, form of and changes in channel, capacity to transport sediment, amount of material supplied for transportation, etc.

REGULATORY FLOODWAY - The floodplain area that is reserved in an open manner by Federal, State or local requirements, i.e., unconfined or unobstructed either horizontally or vertically, to provide for the discharge of the base flood so that the cumulative increase in water surface elevation is no more than a designated amount (not to exceed 1 foot as established by the Federal Emergency Management Agency (FEMA) for administering the National Flood Insurance Program).

RESTORE - To reestablish a setting or environment in which the functions of the natural and beneficial floodplain values adversely impacted by the development or improvements can again operate.

RETENTION - The prevention of runoff from entering the sewer system by storing it on a surface area or in a storage basin.

RETENTION BASIN POND - A man-made depression or impoundment or retain surface runoff waters.

RISK - The consequences associated with the probability of flooding attributable to an encroachment. It shall include the potential for property loss and hazard to life during the service life of the street.

RISK ANALYSIS - An economic comparison of design alternatives using expected total costs (construction costs plus risk costs) to determine the alternative with the least total expected cost to the public. It shall include probable flood-related costs during the service life of the facility for street operation, maintenance, and repair, for street-aggravated flood damage to other property, and for additional or interrupted street travel.

ROUGHNESS COEFFICIENT - A factor in the Kutter, Manning, and other flow formulas representing the effect of channel (or conduit) roughness upon energy losses in the flowing water.

RUNOFF - That part of the precipitation that runs off the surface of a drainage area and reaches a stream or other body of water or a drain or sewer.

SCOUR - The result of erosive action of running water, primarily in streams, excavating and carrying away material from the bed and banks.

SCOUR, GENERAL - The removal of material from the bed and banks across all or most of the width of a channel, as a result of a flow contraction that causes increased velocities and bed shear stress. Also known as **CONTRACTION SCOUR**.

SCOUR, LOCAL - Removal of material from the channel bed or banks which is restricted to a minor part of the width of a channel. This scour occurs around piers and embankments and is caused by the actions of vortex systems induced by the obstructions to the flow.

SCOUR, NATURAL - Removal of material from the channel bed or banks that occurs in streams with the migration of bed forms, shifting of the thalweg and at bends and natural contractions.

SEDIMENT - Fragmentary material that originates from weathering of rocks and is transported by, suspended in, or deposited by water.

SEDIMENTATION BASIN - A basin or tank in which storm water containing settleable solids is retained to remove by gravity a part of the suspended matter.

SIGNIFICANT ENCROACHMENT - A street encroachment and any direct support of likely base floodplain development that would involve one or more of the following construction - or flood-related impacts:

- (1) a significant potential for interruption or termination of a transportation facility that is needed for emergency vehicles or provides a community's only evacuation route,
- (2) a significant risk, or

- (3) a significant adverse impact on natural and beneficial floodplain values.

SIPHON - (inverted) - A conduit or culvert with a U or V shaped grade line to permit it to pass under an intersecting roadway, stream or other obstruction.

SPECIFIC ENERGY - The energy contained in a stream of water, expressed in terms of head, referred to the bed of a stream. It is equal to the mean depth of water plus the velocity head of the mean velocity.

SPILLWAY - A low-level passage serving a dam or reservoir through which surplus water may be discharged; usually an open ditch around the end of a dam, or a gateway or a pipe in a dam. --An outlet pipe, flume or channel serving to discharge water from a ditch, ditch check, gutter or embankment protector.

SPRING BOX - An enclosure constructed to protect a flow of water emerging from the ground.

SSHC – The Arkansas Highway and Transportation Department's Standard Specifications for Highway Construction, latest edition, unless specifically noted otherwise.

STAGE - The elevation of a water surface above a datum of reference.

STEADYFLOW - A flow in which the flow rate or quantity of fluid passing a given point per unit of time remains constant.

STORAGE BASIN - A basin excavated in the earth for detention or retention of water for future flow.

SUBCRITICAL FLOW - Flow with a Froude number less than one. In this state the role played by gravity forces is more pronounced, so the flow has a low velocity and is often described as tranquil and streaming.

SUPERCritical FLOW - Flow with a Froude number greater than one. In this state, the inertia forces become dominant, so the flow has a high velocity and is usually described as rapid, shooting and torrential.

SUPPORT BASE FLOODPLAIN DEVELOPMENT - To encourage, allow, serve, or otherwise facilitate additional base floodplain-development. Direct support results from an encroachment, while indirect support results from an action out of the base floodplain.

SURFACE STORAGE - Storm water that is contained in surface depressions or basins.

SURFACE WATER - Water appearing on the surface in a diffused state, with no permanent source of supply or regular course for a considerable time; as distinguished from water appearing in water courses, lakes, or ponds.

SWALE - A slight depression in the ground surface where water collects.

SYNTHETIC HYDROGRAPH - A graph developed for an ungaged drainage area, based on known physical characteristics of the watershed basin.

TIME OF CONCENTRATION - Time required for storm water runoff to arrive at the point of concentration (usually the inlet to the storm drain) from the most remote point of the drainage area.

TAILWATER - The water surface just downstream from a structure.

UNIFORM FLOW - Flow in which the velocities are the same in both magnitude and direction from point to point along the stream or conduit, all stream lines being parallel.

UNSTEADY FLOW - A flow in which the velocity changes with respect to both space and time.

UNIT HYDROGRAPH - A hydrograph of a direct runoff resulting from 1 inch of effective rainfall generated uniformly over the watershed area during a specified period of time or duration.

WATER COURSE - A natural or artificial channel in which a flow of water occurs, either continuously or intermittently. Natural watercourses may be either on the surface or underground.

WATERSHED - Region or area contributing to the supply of a stream or lake; drainage area, drainage basin, catchment area.

WETTED PERIMETER - The length of the wetted contact between the water and the containing conduit (measured along a plane at right angles to the conduit).

ZERO INCREASE IN DISCHARGE - A storm sewer management concept that suggests no increase in runoff as a result of new development. Any increased flow generated by the development would be taken care of by subsurface disposal (infiltration).

1.2 GENERAL

The Stormwater Management and Drainage Plans and Specifications shall be prepared by the Engineer of Record, who is a licensed professional engineer of the State of Arkansas.

No building permits or subdivision approvals shall be issued until and unless the Stormwater Management Drainage Plans have been approved by the City of Tontitown. Review and approval of the Plan by the City is not intended to modify or replace the

Developer's or Contractor's responsibility to submit and satisfy the Arkansas Department of Environmental Quality NPDES general permit requirements for stormwater discharges associated with construction activity. In order to minimize review time by the City, one set of reports, letters, and plans and specifications for the proposed improvements will be submitted.

1.2.1 CONCEPTUAL STORMWATER MANAGEMENT AND DRAINAGE PLAN

A conceptual Stormwater Management and Drainage Plan review with the City Engineer is suggested before platting, replats, lot-splits, building permits, and/or development improvements begin for the purpose of overall general drainage concept review.

1.2.2 PRELIMINARY STORMWATER MANAGEMENT AND DRAINAGE PLAN

A preliminary Stormwater Management and Drainage Plan and accompanying information as described in the Drainage Criteria Manual shall be submitted at the time of the preliminary plat, replat, lot-split, building permit and/or development improvements are submitted. If needed, a review meeting will be scheduled by the City with representatives of the Developer, including the Engineer, to review the overall concepts included in the preliminary Stormwater Management and Drainage Plan. The purpose of this review shall be to jointly agree upon an overall stormwater management concept for the proposed development and to review criteria and design parameters that shall apply to the final design and of permanent stormwater management practices of the project.

1.2.3 FINAL STORMWATER MANAGEMENT AND DRAINAGE PLAN

Following the preliminary Stormwater Management and Drainage Plan review, the final Stormwater Management and Drainage Plan shall be prepared for each phase of the proposed project as each phase is developed. The final plan shall constitute a refinement of the concepts approved in the preliminary Stormwater Management and Drainage, and Plan, with preparation and submittal of detailed information as required in the Drainage Criteria Manual. This plan shall be submitted at the time construction drawings are submitted for approval.

On combination roadway-drainage projects, it is not the intent that completely separate storm drainage plans be prepared. Where the required details of the proposed storm drainage system can adequately be shown on the roadway plans without sacrificing clarity, the roadway plans will be sufficient. If a combined project submittal is made for review of only roadway or only storm drainage aspects of the project, this fact shall be clearly indicated in large, bold lettering on the Title Sheet.

1.3 DRAINAGE REPORT

A Preliminary Drainage Report shall be required at the time of the Preliminary Plat submittal and may be required for a replat, lot split, large scale development, or building and/or development improvements. One copy of the drainage report, letters, and plans shall be submitted and contain at a minimum the following information:

1. The general drainage patterns within the site, along with the location of all streams, springs, wetlands, and other drainage features.
2. A drainage area map will be provided that illustrates the offsite areas and drainage ways that contribute stormwater flows to the site. The drainage area map will be at a scale of 1"=100' or 1"=200'.
3. The location and nature of each drainage way downstream that will receive flows from the site.
4. A general schematic and preliminary design concept of the proposed improvements in sufficient detail to show proposed underground and overland flows, channels and storm sewer piping (or proposed absence thereof).
5. The preliminary calculated pre-development and post- development flows and runoff for the design storm, 50-year, and 100-year storm events. Include the preliminary calculations for (a) the flow entering the site, (b) the flow generated on the site, and (c) the total flow leaving the site.
6. If detention is proposed, then the preliminary report shall contain sufficient general drainage design to determine the basins, sub-basins, and requirements to route the runoff through the detention pond(s). Further, the detention pond design shall be a "final" design in sufficient detail to establish a final size, depth, location, and detail requirements to justify or prove the application of detention. If detention is not proposed, then supporting calculations and documentation of downstream conditions must be provided.
7. A written summary describing items 1 – 6 above.

Either the City Staff or the Planning Commission may request a more detailed drainage study prior to the Preliminary Plat approval.

A Final Drainage Report will be included with the drawings described below. One copy of the final drainage report and letters shall be submitted and will include documentation and calculations supporting the installation of the proposed improvements(s), as outlined in the Drainage Report checklist included at the end of this section. It is permissible to combine the preceding items when legibility and readability are maintained.

If hydrologic and hydraulic studies reveal that the proposed development would cause increased frequency of flooding, depth of inundation of structures, or inundation of unprotected structures not previously subject to inundation, then the construction permit application shall be denied unless one or more of the following mitigation measures are approved by the City: (1) onsite storage, (2) offsite storage, or (3) improve the drainage system.

If it is determined that offsite drainage improvements are required, then cost sharing will be subject to City Council approval.

1.4 PLANS AND SPECIFICATIONS

Plans and Specifications for storm drainage plans are to be signed by a licensed professional engineer registered in the State of Arkansas (the Engineer of Record). Because all plans, specifications, and calculations are retained by the City for use as permanent records, neatness, clarity, and completeness are very important, and lack of these qualities will be considered sufficient basis for submittal rejection.

Plan sheet size will be 24" x 36" with all sheets in a given set of plans the same size. Larger sheets may be used with approval by the City on a case-by-case basis. Plan drawings will be prepared with a maximum horizontal scale of 1" = 50'. Profile drawings for storm sewers should be drawn to a suggested horizontal scale of 1" = 20', with a maximum scale of 1" = 50' and vertical exaggeration of 10 to 1. Drainage ditch profile should be drawn at the suggested horizontal scale of 1" = 20', with a maximum scale of 1" = 50' and a vertical exaggeration of 10 to 1. Special cases may warrant use of larger or smaller scale drawings for increased clarity or conciseness of the plans and may be used with prior permission of the City.

Each sheet in a set of Plans shall contain a sheet number, the total number of sheets in the Plans, proper project identification, and the date. Revised sheets submitted must contain a revision block with identifying notations and dates for revisions. Each sheet shall bear the signature and seal of the Engineer of Record, along with any appropriate Certificate of Authorization seal for the engineering company.

Four sets of plans and specifications for the proposed improvements will be submitted in the following format during the platting process, where pertinent, and shall include: (1) Title Sheet, (2) General Layout Sheet, (3) Right-of-Way Sheet, (4) Plan and Profile Sheet(s), and (5) Standard and Special Detail Sheets. Drainage area maps and drainage calculations shall be included in the Drainage Report.

Approval of the detailed plans and specifications by the City and/or City Engineer does not constitute a warranty of the plans and specifications and does not relieve the Engineer of Record of his professional responsibility in the design of the facilities or in the preparation of any engineering reports done in association with the project.

1.3.1 TITLE SHEET

Title sheet shall include:

1. The designation of the project, which includes the nature of the project, legal description, the name or title, city, and state.
2. Engineer's project number.
3. Index of sheets.
4. Location maps showing project location in relation to streets, railroads, and physical features. The location map shall have a north arrow and appropriate scale.
5. A project control benchmark identified as to the location and elevation. All elevations shall be based on the North American Vertical Datum of 1988 (NAVD 88) and all horizontal controls shall tie to the State Plane Coordinate System. Both vertical and horizontal controls shall be tied to permanent monuments approved by the City.
6. The name, address, and telephone number of the owner of the project and the name, address, and telephone number of the engineer preparing the plans.

1.3.2 GENERAL LAYOUT SHEET

The General Layout Sheet shall include:

1. North arrow and scale.
2. Legend of symbols that will apply to all sheets.
3. Name of development, if applicable, and all street names and an accurate tie to at least one monumented quarter section corner. Unplatted tracts should have an accurate tie to at least one-quarter section corner.
4. Boundary line or project area.
5. Location and description of existing major drainage facilities within or adjacent to the project area.

6. Location of major proposed drainage facilities.
7. Name, location, and size of each utility within or adjacent to the project area.
8. "One-Call" number will be noted on plans.
9. If more than one General Layout Sheet is required, a match line should be used to show continuation of coverage from one sheet to the next sheet.

1.3.3 OTHER REQUIREMENTS

1. Proposed grading, drainage, paving, and building and profiles of the streets and storm drainage systems and appurtenances.
2. Elevations on profiles or sections or as indicated on Plans shall be based on the North American Vertical Datum of 1988 (NAVD 88). At least one permanent benchmark within each project shall be noted on the first drawing of each project, and their location and elevation shall be clearly defined.
3. Top of curb elevations will be noted at every inlet or drainage structure along the street. Top of inlet or structures elevations will be on all structures not adjacent to the curb.
4. The top of each page shall be either north or east. The stationing of street plans and profiles shall be from left to right and downstream to upstream in the case of channel improvement/construction projects, unless otherwise approved by the City Staff.
5. Each project shall show at least 50' of topography on each side of the proposed improvement. At least 100' of topography shall be shown in areas of channel flow at the property boundary. All existing topography and any proposed changes, including existing utilities, telephone installations, etc., shall be shown on the plans and profiles.
6. Revisions to drawings shall be indicated above the title block in a revision block and shall show the nature of the revision and the date made.
7. Existing and proposed features shall be clearly distinguishable on the plans. All existing utilities, telephone installations, sanitary and storm sewers, pavements, curbs, inlets, and culverts, etc.,

shall be shown by broken lines or by screened printing. Proposed facilities shall be shown by solid lines; and land, lot, and property lines by a distinguishable linetype. Easements shall be shown.

8. Lot lines and dimensions shall be shown where applicable.
9. The water surface elevation (WSE) resulting from the 100-year storm for all overland flow, including flow in the streets, parking lots, swales and between lots shall be calculated and shown on the construction drawings and the final plat.
10. Minimum floor elevation shall be shown a minimum of 2-feet above the 100-year flood elevation on each lot when located in a designated FEMA floodplain and in areas where flooding is known to occur. Minimum floor elevations for other areas shall be a minimum of 1-foot above the calculated 100-year WSE of open channels, swales, or overland flow.
11. It shall be understood that the requirements outlined in these standards are only minimum requirements and shall only be applied when conditions, design criteria, and materials conform to the City Specifications. When unusual subsoil or drainage conditions are suspected, an investigation should be made and a special design prepared in line with good engineering practice.

DRAINAGE REPORT CHECKLIST
CITY OF TONTITOWN, ARKANSAS
REVISION NO. _____
DATE _____

- ___ 1. PROJECT TITLE & DATE
- ___ 2. PROJECT LOCATION - Include street address and Vicinity Map.
- ___ 3. PROJECT DESCRIPTION - Brief description of the proposed project.
- ___ 4. PROJECT OWNER, ADDRESS, AND TELEPHONE NUMBER of the owner and developer, and proof of ownership for the property to be permitted.
- ___ 5. SITE AREA TOPOGRAPHIC MAP - To the nearest 0.1 acre, showing the location and elevation of benchmarks, including at least one benchmark for each control structure.
- ___ 6. DRAINAGE AREA MAP of the project vicinity, covering the project area and the total lands that contributes runoff. An aerial photograph, if available, is preferred.
- ___ 7. LAND USE MAP showing both current and proposed conditions for the drainage area that contributes runoff.
- ___ 8. SOILS AND VEGETATION MAP displaying the most recent U.S. Soil Conversation Service information and encompassing both the project area and the drainage area that contributes runoff.
- ___ 9. UPSTREAM AND DOWNSTREAM DRAINAGE - Brief description of the drainage path from the proposed site shown on a 1" = 200' minimum scale, 2-foot contour topographic map.
- ___ 10. AREA DRAINAGE PROBLEMS - Description of any known onsite or downstream drainage/flooding problems
- ___ 11. SITE DRAINAGE - Description of site drainage for proposed project - include exhibit depicting different drainage areas and flow patterns (existing and proposed)
- ___ 12. SUMMARY OF RUNOFF - A table with the design storm, 50-year, and 100-year storm flow comparisons for existing and proposed conditions and detention volumes required if applicable - also describe method used for determining stormwater runoff flows. The summary must include (a) the flows entering the

site, (b) the pre-development flows on the site, (c) the post-development flows generated on the site, and (d) the total flows leaving the site.

- ___ 13. DESIGN STORM DESIGNATED BY Q 2-, 10-, 25-, 50-, and/or 100-year and design flow rate for each culvert, inlet design, open channel, or other drainage structures. Design storm designations shall be summarized by tables.
- ___ 14. OPEN CHANNEL FLOW DESIGN - Include computations for normal depth and velocity (Use Figure 9.2 or equal).
- ___ 15. PAVEMENT DRAINAGE DESIGN - Include width of spread for design flow (Use Figures 6.2 through 6.6, and Figure 7.12 or equal).
- ___ 16. CULVERT DESIGN - Include all computations and check for inlet/outlet control (Use Table 4.3 or equal).
- ___ 17. RUNOFF COMPUTATION (use AHTD Table 5-6).
- ___ 18. STORM SEWER INLET DESIGN - Include all computations (Use Figure 7.12 or equal).
- ___ 19. STORM SEWER DESIGN - Include all computations (Use Table 8.1 and 8.2 or equal).
- ___ 20. 100-YR WATER SURFACE ELEVATION (WSE) COMPUTATION. The water surface elevation (WSE) resulting from the 100-yr storm for all overland flow, including flow in the streets, parking lots, swales and between lots shall be calculated and shown on the construction drawings and the final plat. Minimum floor elevation shall be shown a minimum of 2 ft. above the 100-year floor elevation on each lot when located in a designated floodplain and in areas where flooding is known to occur. Minimum floor elevations for other areas shall be a minimum of 1 foot above the calculated 100-year WSE of open channels, swales or overland flow.
- ___ 21. STORMWATER DETENTION DESIGN - Include the following computations and backup/support data:

SUMMARY OF RUNOFF - A table with 2-, 10-, 25-, 50-, and 100-year storm flow comparisons for existing and proposed conditions and detention volumes required if applicable - also describe method used for determining stormwater runoff flows. The summary must include (a) the flows entering the site, (b) the pre-development flows on the site, (c) the post-development flows generated on the site, and (d) the total flows leaving the site.
- ___ 22. RECOMMENDATIONS/SUMMARY - Description of any drainage improvements to be made to the site - also, the following backup/support data:

- _____ a. Runoff coefficient/CN computations (existing and proposed conditions)
- _____ b. Complete runoff computations for the design storm, 50-year, and 100-year storms (existing and proposed conditions)
- _____ c. Detention required based on runoff computations
 - _____ 1. Detention basin size requirement computations (using an approved method)
 - _____ 2. Release structure design computations (include release rate computations for the 2-, 10-, 25-, 50-, and 100-year storms)
 - _____ 3. Stage-Storage and Stage-Discharge curves for the detention facility

_____ 23. ARKANSAS REGISTERED ENGINEER SEAL – Name, address, and telephone number on letter certifying drainage improvements are constructed to the City of Tontitown Standards and Ordinances.

_____ 24. WRITTEN SUMMARY OF THE IMPROVEMENTS including a summary of the off-site areas, onsite areas, condition of the downstream receiving areas, existing problems, increase flows, proposed improvements, detention or lack of detention and final conclusions.

_____ 25. ADD THE FOLLOWING PARAGRAPH TO THE DRAINAGE LETTER:

"I, _____, Registered Professional Engineer No. _____ in the State of Arkansas, hereby certify that the drainage studies, reports, calculations, designs, and specifications contained in this report have been prepared in accordance with the requirements of the City of Tontitown. Further, I hereby acknowledge that the review of the drainage studies, reports, calculations, designs, and specifications by the City of Tontitown, its consultants, or its representatives cannot and does not relieve me from any professional responsibility or liability."

Signed & Sealed by Professional Engineer

TABLE OF CONTENTS - SECTION 2

SECTION 2 - DETERMINATION OF STORM RUNOFF

- 2.1 General
- 2.2 City of Tontitown Drainage Methods
- 2.3 Rational Method
 - 2.3.1 Runoff Coefficient ("C")
 - 2.3.2 Soil
 - 2.3.3 Selection of Runoff Coefficients
 - 2.3.4 Rainfall Intensity ("I")
 - 2.3.5 Drainage Area (A)
 - 2.3.6 Time of Concentration (tc)
 - 2.3.6.1 Non-Urbanized Watershed
 - 2.3.6.2 Urbanized Watershed
 - 2.3.7 Channel Flow
 - 2.3.8 Application of the Rational Method
 - 2.3.9 Major Storm Analysis
- 2.4 Soil Conservation Service Method, Tabular TR-55
 - 2.4.1 General
 - 2.4.2 Method Fundamentals
 - 2.4.3 Limitations on Tabular Method Use
 - 2.4.4 Tabular Method Use
 - 2.4.4.1 Determination of Runoff Curve Number (RCN)
 - 2.4.4.2 Design Storm Data
 - 2.4.4.3 Direct Runoff Amounts from Design Storm (DRO Values)
 - 2.4.4.4 Modern Approved Computerization
- 2.5 HEC-HMS Computer Model
 - 2.5.1 General
 - 2.5.2 Stream Network Model
 - 2.5.3 Subwatershed Hydrograph Model Component
 - 2.5.4 River Routing Model Component
 - 2.5.5 Reservoir Routing Model Component

2.5.6 Routing and Combining Hydrographs

2.5.7 Design Storm Precipitation

2.5.8 Interception/Infiltration

2.6 Stormwater Runoff Analysis Software

2.6.1 Quick TR-55

2.6.2 HEC-HMS

SECTION 2 - DETERMINATION OF STORM RUNOFF

2.1 GENERAL

Continuous records over many years on the amounts and rates of runoff from the City's streams would provide the best source of data on which to base the design of storm drainage and flood protection systems. Unfortunately, stream flow records of adequate history are not available for the City's drainage ways. Experience based prediction of the probable frequencies and amounts of runoff are not available as a standard practice in determining stormwater runoff and flood flows.

The accepted practice, therefore, is to relate runoffs to rainfall events, events with a lengthy period of record. The correlation of the rainfall events to runoff amounts is a widely accepted practice. Direct correlation provides a means for predicting the rates and amounts of runoff expected from the City's watersheds at various recurrence intervals since runoff events are directly based on known frequency of occurrence for various rainfall events.

Stormwater runoff shall be computed on the total drainage basin assuming full development of the area in accordance with the Land Use Plan at the time of development, except that the least intense zoning allowed for this purpose is R-1. Both runoff factors and time of concentration shall be calculated on a "fully developed" basis.

2.2 CITY OF TONTITOWN DRAINAGE METHODS

There are numerous methods of rainfall computations on which the design of storm drainage and flood control systems are based. Three widely used methods include: The Rational Method, the Soil Conservation Service Technical Release - 55 (SCS TR-55) and the use of the Corps of Engineers HEC-HMS computer program or a similar approved method. One of these three methods should be the basis of all drainage analysis in the City of Tontitown. However, the City may approve other engineering methods of analysis for calculation of stormwater runoff when they are shown to be comparable to the required methods. The area limits and/or ranges for the analysis methods are:

- | | | |
|----|-----------------|-----------------------|
| 1. | Rational Method | Less than 100 acres |
| 2. | SCS TR-55 | Less than 2,000 acres |
| 3. | HEC-HMS | Greater than 60 acres |

Criteria for the preceding three methods are specified in the following sections:

2.3 RATIONAL METHOD

The Rational Method is probably the most frequently used rainfall-runoff method in urban hydrology in the United States. The Rational Method formula is expressed as:

$$Q = C (I) (A)$$

"Q" is defined as the peak rate of runoff in cubic feet per second. Actually, Q is in units of acre-inches per hour, but calculated results differ from cubic feet per second by less than 1 percent. Since the difference is so small, the "Q" value calculated by the equation is universally taken as cubic feet per second or "CFS."

"C" is the dimensionless coefficient of runoff represented in the ratio of the amount of runoff to the amount of rainfall.

"I" is the average intensity of rainfall in inches per hour for a period of time equal to the critical time of full contribution of the drainage area under consideration. This critical time for full contribution is commonly referred to as "time of concentration."

"A" is the area in acres that contributes to runoff at the point of design or the point under consideration.

Basic assumptions associated with use of the Rational Method are as follows:

1. The computed peak rate of runoff to the design point is the function of the average rainfall rate during the time of concentration to that point.
2. The time of concentration is the critical value in determining the design rainfall intensity and is equal to the time required for water to flow from the hydraulically most distant point in the watershed to the point of design.
3. The ratio of runoff to rainfall, "C," is uniform during the entire duration of the storm event.
4. The rate of rainfall or rainfall intensity, "I," is uniform for the entire duration of the storm event and is uniformly distributed over the entire watershed area.

2.3.1 RUNOFF COEFFICIENT ("C")

The proportion of the total rainfall that runs off depends on the relative porosity or imperviousness of the ground surface, the surface slope, and the ponding character of the surface. Impervious surfaces, such as asphalt pavements and roofs of buildings, will be subject to nearly 90 percent runoff, regardless of the slope, after the surfaces have become thoroughly

wet. Onsite inspections and aerial photographs are valuable in estimating the nature of the surfaces within the drainage area.

2.3.2 SOIL

The runoff coefficient "C" in the Rational Method formula is also dependent on the character of the soil. The type and condition of the soil determines its ability to absorb precipitation. The rate at which a soil absorbs precipitation generally decreases if the rainfall continues for an extended period of time. The soil absorption or infiltration rate is also influenced by the presence of soil moisture before a rain (antecedent condition), the rainfall intensity, the proximity of the groundwater table, the degree of soil compaction, the porosity of the subsoil, vegetation, ground slopes, and surface depressions.

2.3.3 SELECTION OF RUNOFF COEFFICIENTS

It should be noted that the runoff coefficient "C" is the variable of the Rational Method that is least susceptible to precise determination. Proper selection requires judgment and experience on the part of the Engineer, and its use in the formula implies a fixed ratio for any given drainage area, which in reality is not the case. A reasonable coefficient must be chosen to represent the integrated effects of infiltration, detention storage, evaporation, retention, flow routing, and interception, all of which affect the time distribution and peak rate of runoff. However, to standardize City Design Computations, Table 2.1 represents standard runoff coefficient values by land use and composite analysis. The values for respective land uses shall govern for all drainage analysis and design projects using the Rational Method.

2.3.4 RAINFALL INTENSITY ("I")

Rainfall intensity is the design rainfall rate in inches per hour for a particular drainage basin or sub-basin. The rainfall intensity is selected on the basis of the design rainfall duration and frequency of occurrence. The design duration is equal to the time of concentration for a drainage area under consideration. Once the time of concentration is known, the design intensity of rainfall may be determined from the rainfall intensity chart (see Table 2.2). The frequency of occurrence is a statistical variable that may be established by the City standards or chosen by the Engineer as a design parameter.

2.3.5 DRAINAGE AREA (A)

The drainage area or the area from which runoff is to be estimated is measured in acres when using the Rational Method. Drainage areas should be calculated using planimetric-topographic maps, supplemented by field surveys where topographic data has changed or where the contour interval is too great to distinguish the exact direction of overland flows.

2.3.6 TIME OF CONCENTRATION (t_c)

The time of concentration used in the Rational Method is a measure of the time of travel required for runoff from the most remote part of the drainage area to reach the design point or the point under consideration.

For non-urban areas, the time of concentration consists of an overland flow time (t_i) plus the time of travel in a combined form, such as a small swale, channel, or drainage way. For urban areas, the time of concentration consists of an inlet time or overland flow time (t_i) plus the time of travel (t_T) in the storm sewer, paved gutter, roadside drainage ditch, or drainage channel. Time of travel (t_T) can be estimated from the hydraulic properties of the storm sewer, gutter, swale, ditch, or drainage way. Overland flow time, on the other hand, will vary with surface slope, surface cover, and distance of surface flow. Thus, the time of concentration can be calculated for both urban and non-urban areas:

$$t_c = t_i + t_T \quad (2.1)$$

In which

t_c = time of concentration (minutes)

t_i = initial, inlet, or overland flow time (minutes)

t_T = travel time in the ditch, channel, gutter, storm sewer, etc. (minutes)

The engineer may use either the kinematic wave equation or the FAA equation for the initial time of concentration.

A limitation on the time of concentration is usually placed on the calculations for the sub-basins in the water shed. Typical ranges for t_c are 5 to 30 minutes. For paved areas the minimum shall be 5 minutes. For overland flow areas the minimum shall be 10 minutes subject to individual design conditions. The minimum recommended for the first residential basin is 10 minutes and 5 minutes for the first industrial/commercial basin.

The size of the basin may require adjustment until the minimum time is achieved.

If a watershed or basin involves a design time of concentration in excess of 30 minutes then the applicability of the Rational Method must be checked.

2.3.6.1 NON-URBANIZED WATERSHED

The initial or overland flow time (t_i) in non-urbanized watersheds may be calculated using Figure 2.1 or the following equation:

$$t_i = 1.8 (1.1 - C)(L^{0.5})/(S^{0.333}) \quad (2.2)$$

Where

t_i	=	initial or overland flow time (minutes)
C	=	runoff coefficient
L	=	length of overland flow, (feet, 300-foot maximum)
S	=	average basin slope (percent)

Equation 2.2 is considered generally adequate for distances up to 300 feet. For longer basin lengths, the runoff will combine and the sheet flow assumption is no longer valid. The time of concentration would then be overland flow in combination with the travel time (t_T), which is calculated using the hydraulic properties of the swale, ditch, or channel. The travel time (t_T) can be estimated with the help of Figure 2.2 and the following equation:

$$t_T = L/60V \quad (2.3)$$

The time of concentration is then the sum of the initial flow time (t_i) and the travel time (t_T).

A limitation on the time of concentration is placed on the calculation for the first subwatershed in the calculation sequence. As the calculation proceeds downstream and additional subwatersheds are added, the limitation no longer applies. The minimum t_c recommended for non-urban watersheds is 5 minutes.

The process of calculating the time of concentration in a non-urbanized basin is illustrated in the following example:

Example No. 1: Time of Concentration in Non-urban Watershed

Given: A 15-acre non-urbanized rangeland watershed. Watershed has a length of 560 feet and an average slope of 1.0 percent. Uppermost 300 feet of watershed has an average land slope of 2.0 percent.

Required: Time of concentration

Solution:

Step 1: First find the runoff coefficient for clay-type-soil grassland. From Table 2.1

$$C = 0.50$$

Step 2: Find the initial (overland) flow time for the uppermost 300 feet of the watershed. From Figure 2.1 or Equation 2.2, t_i for the 300-foot subwatershed length, slope, and C value is:

$$t_i = 1.8(1.1 - 0.50)(300^{0.5}) / (2.0^{0.33})$$

$$t_i = 15 \text{ minutes}$$

Step 3: Find the travel time for the remaining 260 feet of the watershed length. From Figure 2.2, the average travel velocity for the given watershed, slope, and "Short Grass Pasture" curve is:

$$V = 0.7 \text{ ft/sec.}$$

The travel time is calculated using this velocity and 260 feet of travel length.

$$t_T = L/60 * V = 260 \text{ ft.} / (60 \text{ sec/min})(0.7 \text{ ft/sec})$$

$$t_T = 6 \text{ minutes}$$

Step 4: Combine $t_i + t_T$

$$T_c = 15 + 6 = 21 \text{ minutes}$$

2.3.6.2 URBANIZED WATERSHED

Overland flow in urbanized basins can occur from the back of the lot to the street, in parking lots, in greenbelt areas, or within park areas. It can be calculated using the procedure described in Section 2.3.6.1 and Equation 2.2, except the travel time t_T to the first design point or inlet is estimated using the "Paved Area (Sheet Flow) & Shallow Gutter Flow" line in Figure 2.2. For subsequent design points, the time of concentration is calculated by accumulating the travel times in downstream drainage way reaches.

A limitation on the time of concentration is placed on the calculation for the first subwatershed in the calculation sequence. As the calculation proceeds downstream and additional subwatersheds are added, the limitation no longer applies. The maximum t_c recommended for the first residential watershed is 10 minutes (plus or minus 0.5 minutes) and 5 minutes for the first industrial/commercial watershed. The size of the watershed may require adjustment until the maximum t_c is achieved.

The process of calculating the time of concentration in an urbanized watershed is illustrated by the following example:

Example No. 2: Time of Concentration in Urbanized Watershed

Given: A 100-acre single-family residential development. The first sub-basin has a total length of 300 feet. The upper overland flow portion is from the back of a lot and is 100 feet in length at an average slope of 2.0 percent. The overland flow is mostly over grass and a short driveway, which have a composite runoff coefficient of 0.50. The lower 200 feet of the first watershed has an average slope of 1.0 percent.

Required: Time of concentration at the first storm sewer inlet located 300 feet from the top of the first watershed.

Solution:

Step 1: Find the initial (overland) flow time for the uppermost 100 feet at 2.0 percent slope. From Figure 2.1 or Equation 2.2.

$$t_i = 1.8(1.1 - 0.50)(100^{0.5}) / (2.0^{0.33})$$

$$t_i = 8.6 \text{ minutes}$$

Step 2: Using "Paved Area (Sheet Flow) & Shallow Gutter Flow" curve on Figure 2.2, find the average flow velocity for the remaining 200 feet at 1.0 percent slope:

$$V = 2.0 \text{ ft/sec}$$

Step 3: Calculate the travel time t_T using the velocity found in Step 2 and Equation 2.3.

$$t_T = L/60 * V = 200 \text{ feet} / (60 \text{ sec/min})(2.0 \text{ ft/sec})$$

$$t_T = 1.7 \text{ minutes}$$

Step 4: Calculate the time of concentration to the first inlet using Equation 2.1.

$$t_c = t_i + t_T$$

$$t_c = 8.6 + 1.7 = 10.3 \text{ minutes}$$

Step 5: Continue the time of concentration calculations in the downstream direction. The flow calculated at each design point is used to calculate the flow velocity in the downstream pipe, gutter, swale, or channel. This flow velocity is then used to calculate the time of travel to the next downstream design point.

The individual travel times are accumulated in a downstream direction to calculate the time of concentration at each successive downstream design point.

2.3.7 CHANNEL FLOW

The velocity in an open channel or a storm sewer not flowing full can be determined by using Manning's Equation. Channel velocities can also be determined by using backwater profiles. Usually, average flow velocity is determined assuming a bank-full condition.

2.3.8 APPLICATION OF THE RATIONAL METHOD

The first step in applying the Rational Method is to define the boundaries of the entire relevant sub-watersheds tributary to the points of interest. A field check and possibly field surveys should be made for each watershed. At this stage of planning, the possibility for the diversion of runoff should be checked, since the major storm watershed basin does not always coincide with the minor storm watershed. This is often the case in urban areas. For instance, at some street intersection the low flow will stay next to a curb and follow the lowest grade. But when a large flow occurs, the water will be deep enough so that part of the runoff will overflow the street crown and drain into a new watershed.

2.3.9 MAJOR STORM ANALYSIS

When analyzing the major runoff occurring on an area that has a storm sewer system sized for the initial storm, care must be used when applying the Rational Method. Normal application of the Rational Method assumes that the storm sewer collects all of the runoff. For the initial storm design, the time of concentration is dependent upon the flow time in the sewer. However, during the major storm runoff, the sewers will probably be at capacity and would not carry the additional runoff flowing to the inlets. This additional water would then flow overland past the inlets, generally at a lower velocity than the flow in the storm sewers.

If a separate time of concentration analysis is made for the pipe flow and surface flow, a time lag between the surface flow peak and the pipe flow peak will occur. This lag, in effect, will allow the pipe to carry a larger portion of the major storm runoff than would be predicted using the initial storm time of concentration. The basis for this increased benefit is that the excess water from one inlet will flow to the next inlet, using the overland route. If that inlet is also at capacity, the water will often continue on until capacity is available in the inlet and storm sewer system.

2.4 SOIL CONSERVATION SERVICE METHOD, TABULAR TR-55

2.4.1 GENERAL

The Soil Conservation Service tabular method is a synthetic hydrograph method developed specifically for use in urbanized and urbanizing areas. This method is similar to the Rational Method in that runoff is directly related to rainfall amounts through use of runoff curve numbers (RCNs) (See Tables 2.3a, 2.3b, and 2.3c for urban, cultivated agricultural, and other agricultural areas, respectfully). The basic equation used with the tabular method is also very similar to the one used for the Rational Method:

$$q = (\text{DRO}) \times (\text{DA}) \times (\text{HDO})$$

q = Hydrograph coordinate discharge in CFS

DRO = Direct runoff amount in inches

DA = Drainage area in square miles

HDO = Hydrograph distribution ordinate in CSM/inch

CSM/inch = Cubic feet per second per square mile per inch of runoff

Hydrograph coordinates are computed from the hydrograph distribution data in the TR-55 Manual. A coordinate value is computed for each time shown in the distribution data. The calculated "q" results, when plotted against the corresponding times, constitute the runoff hydrograph.

The tabular method is useful in analyzing watersheds involving several sub-areas with complex runoff patterns. The method is most useful in analyzing changes in runoff volume due to development and in evaluating runoff control measures. The SCS tabular method as described here shall be used in all cases where watershed problems involve two or more interacting sub-areas. The SCS tabular method is the suggested method to be used in evaluating the runoff effects of urbanization and the evaluation/design of runoff control measures.

2.4.2 METHOD FUNDAMENTALS

The SCS has completed extensive research in the runoff potential from native soils under specific conditions of pre-wetting and rainfall events.

This research has also extended to correlation of native soil types and land uses in assessing runoff potential. Runoff curve number or RCN values have been developed that approximate the runoff potential from various types of development with respect to native soils. These RCN values are similar to runoff coefficient values used in the Rational Method in that they can be used to estimate the amount of rainfall that will actually result in runoff. The amount of runoff that will occur for a given RCN value is a function of the design rainfall and is termed direct runoff amount (DRO). The RCN values differ from runoff coefficients in that:

1. Their development encompasses a wide range of land uses.
2. Runoff potentials from native soil types are taken into account.
3. The amount of runoff that will occur is the function of both the RCN value and the design rainfall.

Design rainfalls used with a tabular method are 24-hour rainfall amounts taken from the U.S. Weather Bureau data. The data include recurrence intervals or frequencies of occurrence of 10, 25, 50, and 100 years.

Hydrograph distribution ordinates used in the tabular method were developed by computer analysis of many watersheds of various sizes and configurations. The distribution data published in Technical Release No. 55 were developed specifically by computing hydrographs for a 1-square-mile drainage area for a range of times of concentration and routing of the hydrographs through stream reaches with a range of travel times.

One advantage of using the empirically based hydrograph distributions over simpler methods is that the channel storage and overland flow storage effects are taken into account. This feature is particularly useful in the cases involving larger, more complex watersheds.

The biggest advantage of the tabular method over simpler methods is that the runoff effects of different development patterns (both in land use and in drainage facilities) can be easily measured. The effects of a wide variety of runoff control measures can also be measured since the method's work result is in hydrograph form. These features are extremely valuable in watershed management efforts since differences in flow magnitudes are often more important in design decisions than are determinations of precise peak flow values for given conditions. Also, volumetric effects of runoff can be considered with hydrograph methods.

2.4.3 LIMITATIONS ON TABULAR METHOD USE

The tabular method should not be used when large changes in RCN values occur among watershed sub-areas and when runoff volumes are less than about 1-1/2 inches for RCN values less than 60.

The tabular method should not be used for watersheds that have several sub-areas with times of concentration below 6 minutes. In these cases, sub-areas should be combined to produce a time of concentration of at least 6 minutes (0.10 hours) for the combined areas.

2.4.4 TABULAR METHOD USE

2.4.4.1 DETERMINATION OF RUNOFF CURVE NUMBER (RCN)

The RCN determines the amount of runoff that will occur with the given rainfall. Soil types and land use are used to determine the runoff potential.

Calculation of the RCN values for a watershed or sub area proceeds in the same fashion as the calculation of weighted runoff coefficients used in the Rational Method. Area calculations are completed for each land use type within the study area. Table 2.3 lists RCNs for various land uses. A more complete table listing RCN values for specific soil types and land coverage can be found in the TR-55 Manual. These values are used along with the area calculations to arrive at a weighted RCN for the watershed or sub area under consideration. Table 2.5 is a worksheet that is useful in tabulating weighted RCNs for watersheds and watershed sub-areas. Areas can be measured either in acres or square miles. Weighted RCN values should be rounded to the nearest whole number.

2.4.4.2 DESIGN STORM DATA

The tabular method is based on 24-hour rainfall amounts for various design recurrence intervals or frequency of occurrence. These rainfall amounts are taken from the U.S. Weather Bureau Technical Paper No. 40 for the Tontitown area and are shown in Table 2.2.

2.4.4.3 DIRECT RUNOFF AMOUNTS FROM DESIGN STORM (DRO VALUES)

Table 2.4 is a generalized table of direct runoff amounts for given rainfalls and RCNs. This table can be used to interpolate runoff amounts (DRO values) from any combination of RCN between 60 and 98 and rainfall amounts between 1 and 12 inches.

2.4.4.4 MODERN APPROVED COMPUTERIZATION

Modern approved computerization of this design method by experienced engineers is encouraged.

2.5 HEC-HMS COMPUTER MODEL

2.5.1 GENERAL

A unit hydrograph method must be used for watersheds over 200 acres, which is the upper limit for the Rational Method. HEC-HMS (Snyder or SCS method) is suitable for these and smaller watersheds (60 acres suggested minimum).

The HEC-HMS computer program is a hydrologic simulation model developed by the U.S. Army Corps of Engineers Hydrologic Engineering Center. HEC-HMS is the successor to the Corps' well-known HEC-1 modeling program. HEC-HMS has numerous options for determining and routing runoff hydrographs and is well documented. A user's manual is available online, along with a technical reference manual.

The following description of features is taken from the Hydrologic Modeling System HEC-HMS Technical Reference Manual:

“For precipitation-runoff-routing simulation, HEC-HMS provides the following components:

- Precipitation-specification options which can describe an observed (historical) precipitation event, a frequency-based hypothetical precipitation event, or a event that represents the upper limit of precipitation possible at a given location.
- Loss models which can estimate the volume of runoff, given the precipitation and properties of the watershed.
- Direct runoff models that can account for overland flow, storage and energy losses as water runs off a watershed and into the stream channels.
- Hydrologic routing models that account for storage and energy flux as water moves through stream channels.
- Models of naturally occurring confluences and bifurcations.
- Models of water-control measures, including diversions and storage facilities.

These models are similar to those included in HEC-1. In addition to these, HECHMS includes:

- A distributed runoff model for use with distributed precipitation data, such as the data available from weather radar.
- A continuous soil-moisture-accounting model used to simulate the long-term response of a watershed to wetting and drying.

HEC-HMS also includes:

- An automatic calibration package that can estimate certain model parameters and initial conditions, given observations of hydrometeorological conditions.
- Links to a database management system that permits data storage, retrieval and connectivity with other analysis tools available from HEC and other sources.”

For additional information, consult the HEC website at **<http://www.hec.usace.army.mil/software/hec-hms/hechms-hechms.html>**.

2.6 STORMWATER RUNOFF ANALYSIS SOFTWARE

The City will allow the use of the following software or acceptable equal for the estimating stormwater runoff.

2.6.1 TR-55

A computerized version of TR-55 is available for download directly from the U.S. Natural Resources Conservation Service (formerly the Soil Conservation Service.) A user's manual is also available. For more information, refer to the NRCS TR-55 download page at **<http://www.wcc.nrcs.usda.gov/hydro/hydro-tools-models-tr55.html>**

2.6.1 QUICK TR-55

Quick TR-55 is ideal for modeling general hydrology and runoff from site development. In addition to SCS TR-55 Methods, the program can compute hydrographs using the Rational Method, Modified Rational, Santa Barbara, and DeKalb Procedures.

2.6.2 HEC-HMS

HEC-HMS generates hydrographs from rainfall or snowmelt, adds or diverts them, then routes through reaches and reservoirs. HEC-HMS models multiple streams and reservoir networks, and has dam failure simulation capabilities. It handles level-pool routing for reservoirs and detention ponds, and routes through stream reaches using Kinematic Wave, Muskingum, Muskingum-Cunge, Modified Puls, and other methods. HEC-HMS supports multiple methods for computing infiltration and abstraction losses, and computes unit hydrographs using the Clark method, Snyder method, and SCS dimensionless hydrographs. HEC-HMS is available for download directly from the Corps of Engineers. For more information, refer to the HEC-HMS page at **<http://www.hec.usace.army.mil/software/hec-hms/hechms-hechms.html>**.

Slope	Land Use	Soil Classification			
		Sand or Sandy Loam Soils (Pervious)		High Clay Soils (Impervious)	
		Min.	Max.	Min.	Max.
Flat (0 to 1%)	Cultivated	0.25	0.35	0.30	0.40
	Woodlands	0.15	0.20	0.10	0.15
	Pasture	0.20	0.25	0.30	0.40
	Residential	0.50	0.60	0.50	0.60
	Commercial/Industrial	0.60	0.90	0.60	0.90
	Paved	0.90	0.90	0.90	0.90
Rolling (1 to 3.5%)	Cultivated	0.45	0.65	0.50	0.70
	Woodlands	0.15	0.20	0.18	0.25
	Pasture	0.30	0.40	0.35	0.45
	Residential	0.50	0.60	0.50	0.60
	Commercial/Industrial	0.60	0.90	0.60	0.90
	Paved	0.90	0.90	0.90	0.90
Hilly (3.5 to 5.5%)	Cultivated	0.60	0.75	0.70	0.85
	Woodlands	0.20	0.25	0.25	0.30
	Pasture	0.35	0.45	0.45	0.55
	Residential	0.50	0.60	0.50	0.60
	Commercial/Industrial	0.60	0.90	0.60	0.90
	Paved	0.90	0.90	0.90	0.90
Mountainous (over 5.5%)	Woodlands			0.70	0.80
	Bare			0.80	0.90
Grassed ROW slopes		0.70	0.70	0.70	0.70

NOTE: The maximum value for High Clay Soils shall be used unless approved by City Staff.

SOURCE:

City of Springdale Arkansas	RUNOFF COEFFICIENT VALUES	Table 2.1
-----------------------------------	---------------------------	-----------

DURATION MINUTES	2 YEARS	5 YEARS	10 YEARS	25 YEARS	50 YEARS	100 YEARS
5	5.54	6.58	7.34	8.46	9.35	10.22
6	5.35	6.34	7.07	8.15	9.00	9.85
7	5.10	6.09	6.80	7.80	8.68	9.50
8	4.92	5.85	6.54	7.52	8.34	9.14
9	4.72	5.64	6.30	7.29	8.06	8.80
10	4.58	5.45	6.08	7.06	7.78	8.50
11	4.41	5.28	5.88	6.78	7.50	8.25
12	4.27	5.10	5.70	6.55	7.25	7.92
13	4.12	4.92	5.50	6.32	7.00	7.70
14	4.00	4.78	5.34	6.15	6.81	7.45
15	3.88	4.65	5.18	6.00	6.61	7.24
16	3.78	4.54	5.04	5.84	6.45	7.05
17	3.67	4.38	4.91	5.69	6.30	6.90
18	3.55	4.29	4.80	5.55	6.15	6.73
19	3.47	4.17	4.70	5.43	6.00	6.55
20	3.38	4.06	4.59	5.32	5.88	6.43
21	3.29	3.98	4.49	5.20	6.76	6.30
22	3.20	3.89	4.39	5.10	5.65	6.27
23	3.13	3.80	4.30	4.98	5.52	6.08
24	3.05	3.73	4.20	4.89	5.43	5.93
25	2.99	3.66	4.12	4.80	5.32	5.85
26	2.93	3.58	4.06	4.72	5.24	5.75
27	2.87	3.50	3.96	4.62	5.13	5.65
28	2.80	3.44	3.90	4.54	5.05	5.55
29	2.73	3.37	3.83	4.47	4.97	5.46
30	2.69	3.30	3.76	4.40	4.90	5.38
31	2.62	3.24	3.70	4.31	4.80	5.30
32	2.58	3.19	3.64	4.25	4.74	5.20
33	2.52	3.12	3.57	4.18	4.67	5.12
34	2.48	3.07	3.51	4.11	4.60	5.04
35	2.42	3.02	3.46	4.06	4.51	4.98
36	2.40	2.97	3.40	3.99	4.45	4.90
37	2.37	2.92	3.33	3.92	4.50	4.83
38	2.30	2.89	3.28	3.87	4.33	4.78
39	2.28	2.82	3.24	3.81	4.28	4.70
40	2.23	2.79	3.18	3.76	4.20	4.62
41	2.20	2.75	3.13	3.70	4.15	4.58
42	2.16	2.70	3.10	3.65	4.10	4.50
43	2.12	2.67	3.07	3.60	4.05	4.43
44	2.10	2.63	3.01	3.56	3.97	4.40
45	2.07	2.60	2.97	3.51	3.92	4.33
46	2.04	2.55	2.94	3.46	3.87	4.28
47	2.00	2.52	2.90	3.42	3.82	4.22
48	1.98	2.49	2.86	3.37	3.78	4.18
49	1.97	2.47	2.82	3.33	3.72	4.12
50	1.96	2.42	2.79	3.29	3.69	4.08
51	1.90	2.40	2.74	3.25	3.63	4.03
52	1.88	2.36	2.71	3.20	3.60	3.98
53	1.87	2.33	2.69	3.17	3.55	3.92
54	1.86	2.31	2.65	3.14	3.50	3.88
55	1.82	2.29	2.62	3.10	3.46	3.83
56	1.80	2.26	2.59	3.06	3.44	3.80
57	1.79	2.23	2.56	3.02	3.39	3.75
58	1.76	2.21	2.54	2.98	3.35	3.70
59	1.74	2.19	2.50	2.96	3.30	3.67
60	1.73	2.17	2.48	2.90	3.26	3.62
120	1.32	1.41	1.61	1.86	2.09	2.32
180	0.79	1.04	1.20	1.37	1.53	1.72
6 hr	0.48	0.62	0.73	0.84	0.93	1.03
12 hr	0.29	0.37	0.44	0.50	0.56	0.62
24 hr	0.17	0.22	0.25	0.29	0.33	0.36

Source: 5-60 min. NOAA HYDRO-35
60-120 min. interpolated
120 min. - 24 hr. Technical Paper No. 40

RAINFALL INTENSITY CHART
(INCHES PER HOUR)

Revised 1/26/98

TABLE 2-2

Table 2-3a. — Runoff Curve Numbers for Urban Areas^a

Cover Description		Curve Numbers for Hydrologic Soil Group			
Cover Type and Hydrologic Condition	Average Percent Impervious Area ^b	A	B	C	D
<i>Fully developed urban areas (vegetation established)</i>					
Open space (lawns, parks, golf courses, cemeteries, etc.):					
Poor condition (grass cover < 50%)		68	79	86	89
Fair condition (grass cover 50% to 75%)		49	69	79	84
Good condition (grass cover > 75%)		39	61	74	80
Impervious areas:					
Paved parking lots, roofs, driveways, etc. (excluding ROW)		98	98	98	98
Streets and roads:					
Paved; curbs and storm sewers (excluding ROW)		98	98	98	98
Paved; open ditches (including ROW)		83	89	92	93
Gravel (including ROW)		76	85	89	91
Dirt (including ROW)		72	82	87	89
Western desert urban areas:					
Natural desert landscaping (pervious areas only)		63	77	85	88
Artificial desert landscaping (impervious weed barrier, desert shrub with 1-to-2-inch sand or gravel mulch and basin borders)		96	96	96	96
Urban districts:					
Commercial and business	85	89	92	94	95
Industrial	72	81	88	91	93
Residential districts by average lot size:					
1/8 acre or less (town houses)	65	77	85	90	92
1/4 acre	38	61	75	83	87
1/3 acre	30	57	72	81	86
1/2 acre	25	54	70	80	85
1 acre	20	51	68	79	84
2 acres	12	46	65	77	82
<i>Developing urban areas</i>					
Newly graded areas (pervious areas only, no vegetation) ^c		77	86	91	94
Idle lands (CNs are determined using cover types similar to those in Table 2-2c).					

^aAverage runoff condition, and $I_a = 0.25$.

^bThe average percent impervious area shown was used to develop the composite CNs. Other assumptions are as follows: impervious areas are directly connected to the drainage system, impervious areas have a CN of 98, and pervious areas are considered equivalent to open space in good hydrologic condition. CNs for other combinations of conditions may be computed using Figure 2-3 or 2-4.

^cCNs shown are equivalent to those of pasture. Composite CNs may be computed for other combinations of open space cover type.

^dComposite CNs for natural desert landscaping should be computed using Figure 2-3 or 2-4 based on the impervious area percentage (CN = 98) and the pervious area CN. The pervious area CNs are assumed equivalent to desert shrub in poor hydrologic condition.

^eComposite CNs to use for the design of temporary measures during grading and construction should be computed using Figure 2-3 or 2-4, based on the degree of development (impervious area percentage) and the CNs for the newly graded pervious areas.

Notes: CN = Curve number.
ROW = Right-of-way.

Table 2-3b. — Runoff Curve Numbers for Cultivated Agricultural Lands*

Cover Description			Curve Numbers for Hydrologic Soil Group			
Cover Type	Treatment ^b	Hydrologic Condition ^c	A	B	C	D
Fallow	Bare soil	—	77	86	91	94
	Crop residue cover (CR)	Poor	76	85	90	93
Good		74	83	88	90	
Row crops	Straight row (SR)	Poor	72	81	88	91
		Good	67	78	85	89
	SR + CR	Poor	71	80	87	90
		Good	64	75	82	85
	Contoured (C)	Poor	70	79	84	88
		Good	65	75	82	86
	C + CR	Poor	69	78	83	87
		Good	64	74	81	85
	Contoured and terraced (C&T)	Poor	66	74	80	82
		Good	62	71	78	81
C&T = CR	Poor	65	73	79	81	
	Good	61	70	77	80	
Small grain	SR	Poor	65	76	84	88
		Good	63	75	83	87
	SR + CR	Poor	64	75	83	86
		Good	60	72	80	84
	C	Poor	63	74	82	85
		Good	61	73	81	84
	C + CR	Poor	62	73	81	84
		Good	60	72	80	83
	C&T	Poor	61	72	79	82
		Good	59	70	78	81
C&T + CR	Poor	60	71	78	81	
	Good	58	69	77	80	
Close-seeded or broadcast legumes or rotation	SR	Poor	66	77	85	89
		Good	58	72	81	85
meadow	C	Poor	64	75	83	85
		Good	55	69	78	83
	C&T	Poor	63	73	80	83
		Good	51	67	76	80

*Average runoff condition, and $I_a = 0.2S$.

^bCrop residue cover applies only if residue is on at least 5% of the surface throughout the year.

^cHydrologic condition is based on combination of factors that affect infiltration and runoff, including (a) density and canopy of vegetative areas, (b) amount of year-round cover, (c) amount of grass or close-seeded legumes in rotations, (d) percent of residue cover on the land surface (good $\geq 20\%$), and (e) degree of surface roughness.

Notes: *Poor* = Factors impair infiltration and tend to increase runoff.

Good = Factors encourage average and better than average infiltration and tend to decrease runoff.

Table 2-3c. - Runoff Curve Numbers for Other Agricultural Lands^a

Cover Description		Curve Numbers for Hydrologic Soil Group			
Cover Type	Hydrologic Condition ^c	A	B	C	D
Pasture, grassland, or range— continuous forage for grazing ^b	Poor	68	79	86	89
	Fair	49	69	79	84
	Good	39	61	74	80
Meadow—continuous grass, protected from grazing and generally mowed for hay	—	30	58	71	78
Brush—brush-weed-grass mixture with brush the major element ^c	Poor	48	67	77	83
	Fair	35	56	70	77
	Good	30 ^d	48	65	73
Woods—grass combination (orchard or tree farm) ^e	Poor	57	73	82	86
	Fair	43	65	76	82
	Good	32	58	72	79
Woods ^f	Poor	45	66	77	83
	Fair	36	60	73	79
	Good	30 ^d	55	70	77
Farmsteads—buildings, lanes, driveways, and surrounding lots	—	59	74	82	86

^aAverage runoff condition, and $I_p = 0.2S$.

^bPoor = < 50% ground cover or heavily grazed with no mulch.

Fair = 50 to 75% ground cover and not heavily grazed.

Good = 75% ground cover and lightly or only occasionally grazed.

^cPoor = < 50% ground cover.

Fair = 50 to 75% ground cover.

Good = 75% ground cover.

^dActual curve number is less than 30; use CN = 30 for runoff computations.

^eCNs shown were computed for areas with 50% woods and 50% grass (pasture) cover. Other combinations of conditions may be computed from the CNs for woods and pasture.

^fPoor = Forest litter, small trees, and brush are destroyed by heavy grazing or regular burning.

Fair = Woods are grazed but not burned, and some forest litter covers the soil.

Good = Woods are protected from grazing, and litter and brush adequately cover the soil.

Rainfall (Inches)	Runoff Curve Number (RCN)								
	60	65	70	75	80	85	90	95	98
1.0	0	0	0	0.03	0.08	0.17	0.32	.56	.79
1.2	0	0	0.03	0.07	0.15	0.28	0.46	.74	.99
1.4	0	0.02	0.06	0.13	0.24	0.39	0.61	.92	1.18
1.6	0.01	0.05	0.11	0.20	0.34	0.52	0.76	1.11	1.36
1.8	0.03	0.09	0.17	0.29	0.44	0.65	0.93	1.29	1.58
2.0	0.06	0.14	0.24	0.38	0.56	0.80	1.09	1.48	1.77
2.5	0.17	0.30	0.46	0.65	0.89	1.18	1.53	1.96	2.27
3.0	0.33	0.51	0.72	0.96	1.25	1.59	1.98	2.45	2.78
4.0	0.76	1.03	1.33	1.67	2.04	2.46	2.92	3.43	3.77
5.0	1.30	1.65	2.04	2.45	2.89	3.37	3.88	4.42	4.76
6.0	1.92	2.35	2.80	3.28	3.78	4.31	4.85	5.41	5.76
7.0	2.60	3.10	3.62	4.15	4.69	5.26	5.82	6.41	6.76
8.0	3.33	3.90	4.47	5.04	5.62	6.22	6.81	7.40	7.76
9.0	4.10	4.72	5.34	5.95	6.57	7.19	7.79	8.40	8.76
10.0	4.90	5.57	6.23	6.88	7.52	8.16	8.78	9.40	9.76
11.0	5.72	6.44	7.13	7.82	8.48	9.14	9.77	10.39	10.76
12.0	6.56	7.32	8.05	8.76	9.45	10.12	10.76	11.39	11.76

1/ To obtain runoff depths for RCN's and other rainfall amounts not shown in this Table, use an arithmetic interpolation.

DIRECT RUNOFF VALUES
BY RCN'S AND RAINFALL AMOUNTS

Source: U.S. Soil Conservation Service
Technical Release No. 55

RUNOFF CURVE NUMBER WORKSHEET

Subbasin _____

LAND USE	RCN	ACRES	RCN X ACRES
TOTALS			

$$\text{WEIGHTED RCN} = \frac{\text{Total (RCN X Acres)}}{\text{TOTAL ACRES}} =$$

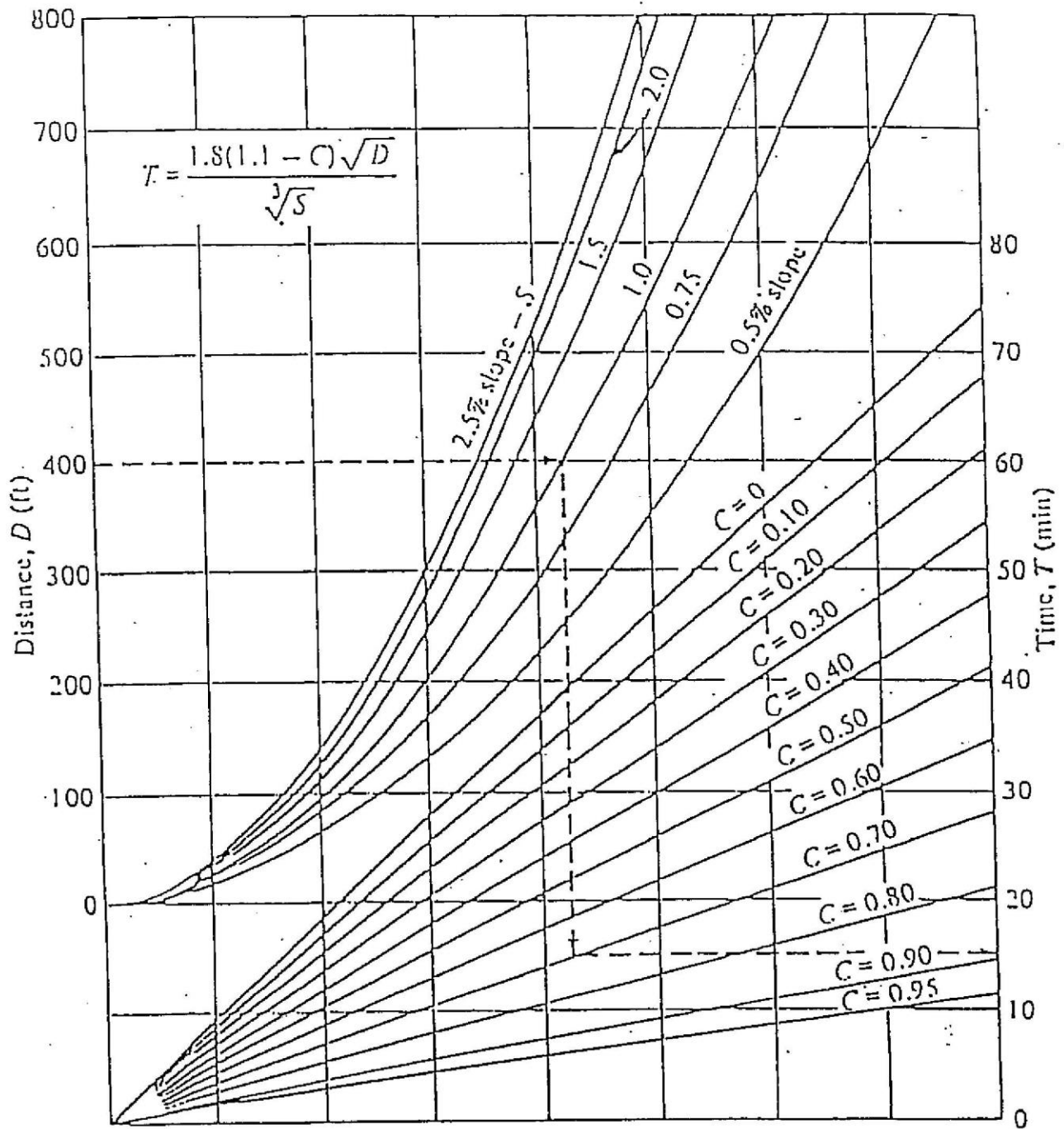

T = Time of concentration in minutes
 C = Average Runoff Coefficient
 D = Length of overland flow in feet
 S = Slope percentage

NOTE: For use in determining overland flow, time of concentration

SOURCE: "AIRPORT DRAINAGE" FEDERAL AVIATION AGENCY
 DEPARTMENT OF TRANSPORTATION

RATIONAL METHOD
 TRAVEL TIME FOR OVERLAND FLOW/
 NON-URBANIZED WATERSHEDS

Figure 2.1

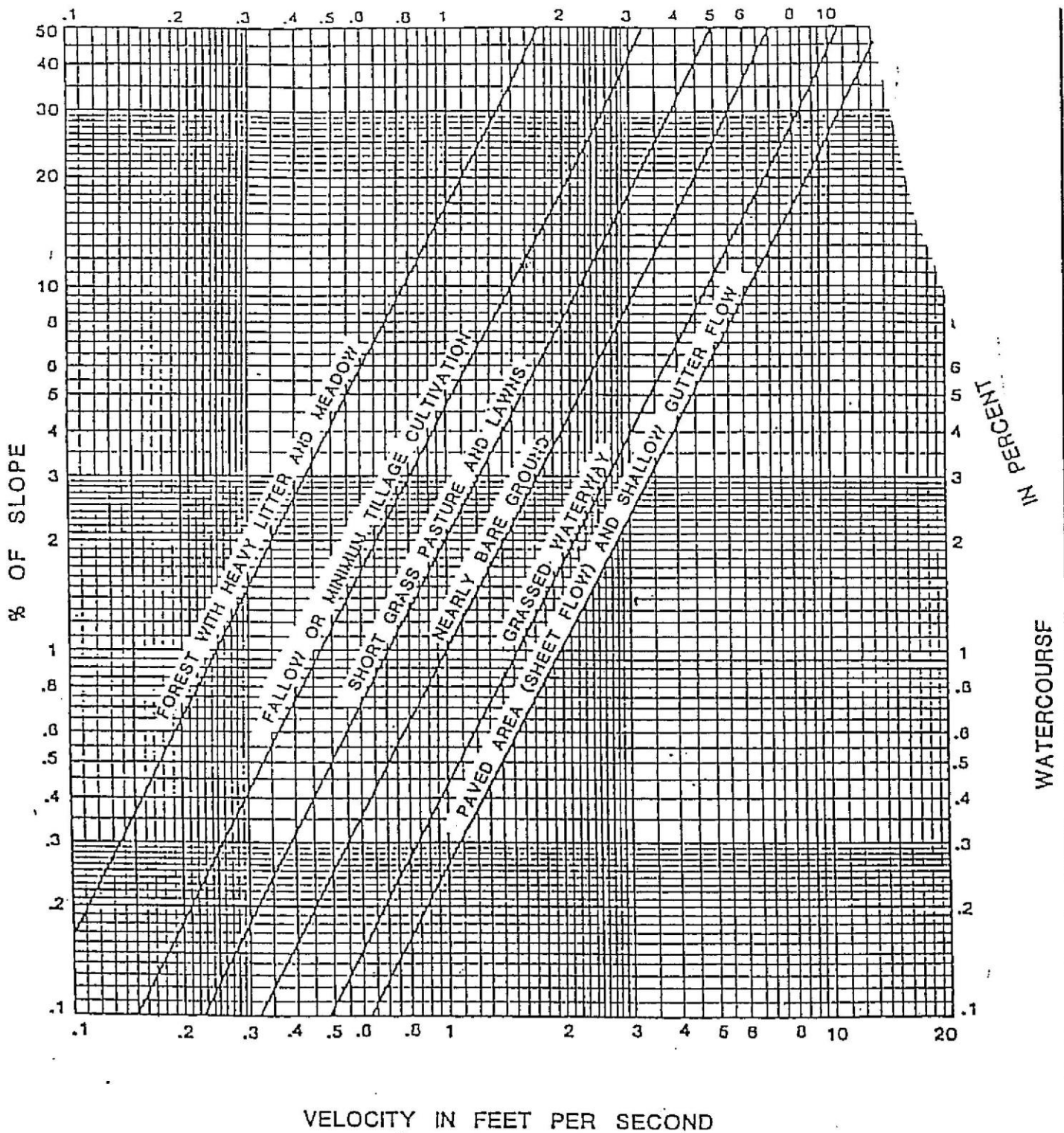

SOURCE: U.S. SOIL CONSERVATION SERVICE.
 TECHNICAL RELEASE #55

RATIONAL METHOD
 TRAVEL TIME VELOCITY FOR RATIONAL METHOD
 CHANNELIZED FLOW

Figure 2.2

TABLE OF CONTENTS - SECTION 3

SECTION 3 - FLOW IN STORM DRAINS AND DRAINAGE APPURTENANCES

- 3.1 General
- 3.2 Storm Sewer Design Requirements
 - 3.2.1 Minor and Major Drainage System
 - 3.2.2 Drainage Channels
 - 3.2.2.1 Primary Drainage Channels
 - 3.2.2.2 Secondary Drainage Channels and Surface Drainage
- 3.3 Requirements Relative To Improvements
 - 3.3.1 Bridges and Culverts
 - 3.3.2 Closed Storm Sewer
 - 3.3.3 Minimum Grades
 - 3.3.4 Earthen Channels (a.k.a., Open Ditches)
 - 3.3.5 Open Paved Channels
- 3.4 Full Or Part-Full Flow In Storm Drains
 - 3.4.1 General
 - 3.4.2 Roughness Coefficients
 - 3.4.3 Minor Head Losses at Structures
 - 3.4.4 Manhole Locations
 - 3.4.5 Pipe Flow Charts
- 3.5 Utilities

SECTION 3 - FLOW IN STORM DRAINS AND DRAINAGE APPURTENANCES

3.1 GENERAL

A general description of storm drainage systems and quantities of storm runoff is contained in this section and Section II of this manual. It is the purpose of this section to consider the significance of the hydraulic elements of the storm drainage system.

Hydraulically, storm drainage systems are conduits (open or closed) in which unsteady and non-uniform free flow exists. Storm drains accordingly are designed for open-channel flow to satisfy as well as possible the requirements for unsteady and non-uniform flow. Steady flow conditions may or may not be uniform.

The construction standards for culverts and bridges shall be in strict accordance with the latest published AHTD standards, or as amended by the City of Tontitown ordinances.

All storm sewers shall be designed on the total drainage basin assuming full development of the area in accordance with the land use plan designation at the time of development, except that the least intense zoning allowed for this purpose is R-1. Both runoff factors and time of concentration shall be calculated on a "fully developed" basis.

The City reserves the right to require improvements, provision of drainage easements, and for provision of agreements beyond the boundaries of the development to facilitate flow of water through the development, and to avoid possibility of lawsuits based on damage from changed runoff in the addition, and also to provide continuous improvements of the overall storm drainage system. The developers, to include corporate entities, shall be responsible at their expense for making off-site improvements necessary to correct drainage or flooding problems created by their development.

If it is determined that off-site drainage improvements are required then cost sharing may be considered with approval by the City Council. If the City is unable to or unwilling to contribute its share of the offsite costs, the developer shall have the option of (a) building the offsite improvements at his or her own expense, (b) providing detention to match downstream capacities, or (c) delaying the project until the City is able to share in the offsite costs. Detention must be approved by the City.

3.2 STORM SEWER DESIGN REQUIREMENTS

A formal Drainage Report shall be required for each subdivision and large-scale development. A preliminary report will be required at the time of the Preliminary Plat submittal as outlined in Section 1, Submittal Procedures.

3.2.1 MINOR AND MAJOR DRAINAGE SYSTEMS

All urbanized watersheds are considered to have two drainage systems. The first is commonly referred to as a Minor Drainage System and the other is the Major Drainage System.

The Minor Drainage System is designed to convey runoff from frequent minor rainfall events up to a predetermined design recurrence interval. Runoff from these rainfall events is typically conveyed in the curb and gutter (subject to the limitations defined in this manual), roadside ditches, storm sewers, small channels or swales, or other minor conveyance systems.

The Major Drainage System is designed to convey runoff from rainfall events up to the 100-year recurrence interval. The purpose of the Major Drainage System is to minimize flood impacts to health and life, damage to structures, and interruption of emergency traffic and services. Major storm runoff is typically conveyed through the urban street system (subject to the limitations defined in this manual), open drainage channels, large conduits, and other conveyance facilities.

Both the minor and major drainage systems typically utilize the urban street system for conveyance of storm water runoff. If a storm event generates runoff in excess of the capacity of the minor drainage system (i.e., curb and gutter, storm sewers, etc.), then the major system conveys the overflow. In an urban environment the street would typically convey the excess runoff as a channel. All subdivisions will include the planning, design, and implementation of the minor and major drainage systems.

3.2.2 DRAINAGE CHANNELS

3.2.2.1 PRIMARY DRAINAGE CHANNELS

All primary drainage channels lying within or immediately adjacent to the development shall meet the following conditions:

1. All land within the floodway shall be dedicated to the city for the purpose of providing drainage and for public parks and utility easement use.
2. The existing channel lying within or immediately adjacent to the development shall be cleaned to provide for the free flow of water, and the channel shall be straightened, widened and improved to the extent required to prevent overflow beyond the limits of the dedicated drainage area. This type of construction is subject to constraints imposed by the U.S. Army Corps of Engineers, and appropriate permitting for the construction shall be the responsibility of the Developer.

3. Site improvements shall provide for the grading of all building sites and streets to an elevation where all building sites will not be subject to overflow, and in a manner that will provide for the rapid runoff of all rainfall.
4. Whenever channel improvement is carried out, sodding, backsloping, cribbing and other bank protection shall be designed and constructed to control erosion for all the anticipated conditions of flow for the segment of channel involved.
5. Open drainage channels shall not be constructed in a street easement or right-of-way. Existing roadside ditches shall be enclosed in closed conduits as part of the development requirements.
6. Culverts, bridges and other drainage structures shall be constructed in accordance with the specifications of the city of all locations where drainage channels intersect with continuous street or alleys.

3.2.2.2 SECONDARY DRAINAGE CHANNELS AND SURFACE DRAINAGE

Surface drainage and all secondary channels within, or adjacent to the development shall meet the following conditions:

1. Secondary drainage channels, which have a primary function of collecting surface water from adjacent properties or interception and diverting side hill drainage, shall be provided with an improved open channel.
2. Secondary drainage channels which have a primary function of transporting water through the block or collecting water from cross channels and which have a drainage area of less than ten acres shall be improved with closed storm sewers; and where the secondary drainage channel has a drainage area of greater than ten acres an improved open channel or closed storm sewer shall be provided, as approved by the City Staff.

3. A drainage channel shall not be located in a street easement unless it is placed in a closed storm sewer, or unless a paved street surface is located on both sides of a paved drainage channel to give access to abutting properties.
4. Site grading shall be carried out in such a manner that surface water from each lot will flow without diversion to a storm sewer, improved channel or paved street.
5. Surface water collected on streets shall be diverted to storm drains at satisfactory intervals to prevent overflow of standard city curbs during a 50-year frequency rain for the area and grades involved. Drainage area allowed for surface flow on streets at point of diversion shall not exceed ten acres, regardless of flow.

3.3 REQUIREMENTS RELATIVE TO IMPROVEMENTS

3.3.1 BRIDGES AND CULVERTS

When bridges are provided where continuous streets or alleys cross watercourses, they shall be designed to accommodate the design storm by providing 1 foot of freeboard, measured from the low chord to the design storm water surface.

When culverts are provided where continuous streets or alleys cross watercourses, they shall be designed to accommodate the design storm by providing 1 foot of freeboard, measured from the top of the road/curb to the design storm water surface.

The structure shall be designed in accordance with current Arkansas Highway and Transportation Department specification materials and to carry a minimum HS-20 loadings in any case.

3.3.2 CLOSED STORM SEWER

Closed storm sewers for all conditions other than required in Section 3.3.1 shall be designed to accommodate a design storm, based on the drainage area involved. Closed storm sewers shall be:

- reinforced concrete box culverts for minimum HS-20 loadings
- reinforced concrete pipe; ASTM Class III with a minimum of 1 foot cover
- reinforced concrete pipe; ASTM Class IV when less than 1 foot of cover

- corrugated metal pipe of the required gage with a minimum of 2 feet of cover (except under public or private streets or roads)
- other as approved by the City Staff on a case-by-case basis.

Where closed storm sewers cross between lots to continue into other facilities, a swale or approved equal shall be constructed to provide the combined capacity of the 100-year peak flow. When storm sewers are not designed for the 100-year peak flow and are not within a public street, a drainage easement shall be provided that prohibits structures from blocking the flow. The easement shall be sized to pass the 100-year flow. The 100-year water surface elevation shall be plotted on the design drawings.

3.3.3 MINIMUM GRADES

Storm drains should operate with velocities of flow sufficient to prevent excessive deposition of solid material; otherwise, objectionable clogging may result. The controlling velocity is near the bottom of conduits and considerably less than the mean velocity. Storm drains shall be designed to have a minimum velocity flowing full of 2.5 feet per second (fps). Table 3.1 indicates the grades for both concrete pipe ($n = 0.013$) and for corrugated metal pipe ($n = 0.024$) to produce a velocity of 2.5 fps, which is considered to be the lower limit of scouring velocity. Grades for closed storm sewers and open paved channels shall be designed so that the velocity shall not be less than 2.5 fps nor exceed 20 fps. All other structures such as junction boxes or inlets shall be in accordance with AHTD standard drawings.

Closed storm sewers extending to farthest downstream point of development shall give consideration to velocity and discharge energy dissipators to prevent erosion and scouring along downstream properties.

3.3.4 EARTHEN CHANNELS (a.k.a., OPEN DITCHES)

Open earthen channels may be approved where needed to convey runoff. Such channels shall be designed on a 50-year storm. In all cases for channels, the Design Engineer shall calculate the 100-year flow and show elevations relating to the 100-year flow on the official plat of the development.

Channels shall have a gradient to keep the velocity within 1.5 to 5.0 fps. Sod shall be required to the 25-year storm depth unless approved by the City Staff. Side slopes shall have a minimum slope ratio of 3:1 unless approved by the City Staff. See Table 3.2 for permissible velocities for swales, open channels, and ditches with uniform stands of various well-maintained grass covers. Floodplains are areas of land adjacent to an open sodded ditch (not in closed storm sewers) that may flood

during a 100-year rain. Floodways and floodplains shall be indicated on drainage improvement plans and final plots.

3.3.5 OPEN PAVED CHANNELS

Open paved channels may be approved where needed to intercept runoff. Such channels shall be designed on a 50-year storm. In all cases for open channels, the Design Engineer shall calculate the 100-year flow and show elevations relating to the 100-year flow on the official plat of the development.

Such channels may be of different shapes according to existing conditions. The channel shall be of concrete with a minimum 6-inch thickness paved to the 25-year storm depth. Thickness of concrete and amount of reinforcing steel shall depend upon conditions at site and size of channel.

3.4 FULL OR PART-FULL FLOW IN STORM DRAINS

It is important to recognize that storm drain hydraulics are not the same as culvert hydraulics. See Section 4 for a detailed discussion of culvert hydraulics.

3.4.1 GENERAL

Closed storm sewers or open channels shall be designed so that their capacity will not be less than that computed using Manning's Equation. All storm drains shall be designed by the application of the continuity equation and Manning's Equation, either through the appropriate charts and nomographs, or by direct solutions of the equations as follow:

$$Q = AV \text{ (continuity equation) and} \quad (3.1)$$

$$Q = \frac{1.49}{n} AR^{2/3} S_0^{1/2} \quad \text{(Manning's Equation)} \quad (3.2)$$

$$Q = \text{Capacity} = \text{discharge in cfs}$$

$$A = \text{Cross-sectional area in conduit or channel in square feet}$$

$$P = \text{Wetted perimeter (feet)}$$

$$R = \text{Hydraulic radius} = A / P$$

$$S_0 = \text{Slope of pipe (feet per foot)}$$

$$n = \text{Coefficient of roughness of pipe (Manning's coefficient)}$$

V = Velocity in pipe (fps)

There are several general rules to be observed when designing storm sewers. When followed, they will tend to alleviate or eliminate the common mistakes made in storm sewer design. These rules are as follows:

1. Select pipe size and slope so that the velocity of flow will increase progressively, or at least will not appreciably decrease at inlets, bends, or other changes in geometry or configuration. An 18" pipe diameter is the minimum acceptable pipe diameter for maintenance purposes. Where used, arch pipe sizes shall be hydraulically equivalent to the round pipe size.
2. Do not discharge the contents of a larger pipe into a smaller one, even though the capacity of the smaller pipe may be greater due to steeper slope, unless phased construction is approved by the City.
3. Conduits are to be checked at the time of their design with reference to critical slope. If the slope of the line is greater than critical slope, the unit will likely be operating under entrance control instead of the originally assumed normal flow. Conduit slopes should be kept below critical slope if at all possible. This also removes the possibility of a hydraulic jump within the line.
4. All pipes under streets shall be reinforced concrete pipe unless an alternative material is specifically approved in writing by the City. Pipe not under streets may be coated corrugated metal or spiral metal pipe, or other materials approved by the City, if sufficient cover is provided.

3.4.2 ROUGHNESS COEFFICIENTS

Roughness coefficients for storm drains are shown on Table 3.3.

3.4.3 MINOR HEAD LOSSES AT STRUCTURES

The following total energy head losses at structures shall be determined for inlets, manholes, wye branches or bends, and other junctions in the design of closed conduit. See Figures 3.1 and 3.2 for details of each case. Minimum head loss used at any structure shall be 0.10 foot, unless otherwise approved.

The basic equation for most cases, where there is both upstream and downstream velocity, takes the form as set forth below with the various values of the coefficient of K_j shown in Tables 3.4, 3.5, 3.6, and 3.7.

$$h_j = K_j (V_2^2 - V_1^2)$$

$$2g \tag{3.3}$$

h_j = Junction or structure head loss in feet.

v_1 = Velocity in upstream pipe in fps.

v_2 = Velocity in downstream pipe in fps.

K_j = Junction or structure coefficient of loss.

In the case where the initial velocity is negligible, the equation for head loss becomes:

$$h_j = \frac{K_j V_2^2}{2g} \tag{3.4}$$

The values of the coefficient "K" for determining the loss of head due to obstructions in pipe are shown in Table 3.7, and the coefficients are used in the following equation to calculate the head loss at the obstruction:

$$h_j = \frac{K_j V_2^2}{2g}$$

The values of the coefficient " K_j " for determining the loss of head due to sudden enlargements and sudden contractions in pipes are shown in Tables 3.4, 3.5, and 3.6, and the coefficients are used in the following equation to calculate the head loss at the change in cross section:

$$h_j = \frac{K_j V^2}{2g}$$

Design and Construction of Urban Stormwater Management Systems prepared by American Society of Civil Engineers Manuals and Reports of Engineering Practice No. 77 may also be used as a reference to calculate minor losses associated with transitions, beads, and junctions.

3.4.4 JUNCTION BOX LOCATIONS

Junction boxes ports will be required whenever there is a change in size, direction, elevation, grade, or where there is a junction of two or more sewers. An inlet or junction box shall be required at the upstream end of the storm sewer. The maximum spacing between inlets or junction boxes shall be 400 feet. The required structure size shall be as follows:

STRUCTURE SIZE	
Sewer Diameter	Manhole Size
18" to 36"	4'
42" to 48"	5'
54" to 60"	6'
Larger than 60"	To be approved by City

Larger structure diameters may be required when storm sewer alignments are not straight through or when more than one line goes through the manhole.

3.4.5 PIPE FLOW CHARTS

Figure 3.3 represents relative velocity, area, and discharge velocity in circular pipes for any depth of flow. Pipe-flow nomographs for determining flow properties of circular pipe, elliptical pipe, and pipe arches are illustrated on Figures 3.4 through 3.12. Nomographs are based upon a value of "n" of 0.024 for corrugated metal and 0.012 for concrete. The charts are self-explanatory, and their use is demonstrated by the example in Figure 3.4.

Pipe-flow nomographs for various sizes of pipes and channels are included for reference on Figures 3.14 through 3.41.

For values of "n" other than 0.012, the value of Q should be modified by using the formula below:

$$Q_c = \frac{Q_n(0.012)}{n_c} \quad (3.5)$$

Q_c = Flow based upon n_c

n_c = Value of "n" other than 0.012

Q_n = Flow from nomograph based on $n = 0.012$

This formula is used in two ways. If $n_c = 0.015$ and Q_c is unknown, use the known properties to find Q_n from the nomograph, and then use the formula to convert Q_n to the required Q_c . If Q_c is one of the known properties, you must use the formula to convert Q_c (based on n_c) to Q_n (based on $n = 0.012$) first, and then use Q_n and the other known properties to find the unknown value on the nomograph.

Example 1

Given: Slope = 0.005, depth of flow (d) = 1.8', diameter $D = 36"$, $n = 0.018$

Find: Discharge (Q)

First determine $d/D = 1.8'/3.0' = 0.6$. Then enter Figure 3.4 to read $Q_n = 34$ cfs. Using the formula $Q_c = 34 (0.012/0.018) = 22.7$ cfs (answer).

Example 2

Given: Slope = 0.005; diameter $D = 36"$, $Q = 22.7$ cfs, $n = 0.018$

Find: Velocity of flow (fps)

First convert Q_c to Q_n so that nomograph can be used. Using the formula $Q_n = 22.7 (0.018)/(0.012) = 34$ cfs, enter Figure 3.4 to determine $d/D = 0.6$. Now enter Figure 3.6 to determine $V = 7.5$ fps (answer).

3.5 UTILITIES

In the design of a storm drainage system, the Engineer is frequently confronted with the problem of grade conflict between the proposed storm drain and existing utilities, such as water, gas, and sanitary sewer lines.

When conflicts arise between a proposed drainage system and utility system, the owner of the utility system shall be contacted and made aware of the conflict. Any adjustments necessary to the drainage system or the utility can then be determined.

Due to the difficulty and expense to the public with regard to hand cleaning, clearing, and other channel maintenance, the following channel requirements are specified to expedite small equipment cleaning and access to drainage easements and channels:

- Manholes are not allowed in drainage channels.
- Access easements shall be required every 600 feet.
- Utility crossings above the channel flowline shall not be allowed unless approved in writing by the City.
- Utilities shall not be located beneath a concrete channel bottom except at crossings or be accepted and approved in writing by the City.
- Utilities under earthen channels will have a minimum cover of 3 feet.

Table 3.1
 Minimum Slope Required
 to Produce Scouring Velocity

Pipe Size (Inches)	Concrete Pipe Slope ft./ft.	Corrugated Metal Pipe ft./ft.
18	0.0018	0.0060
21	0.0015	0.0049
24	0.0013	0.0041
27	0.0011	0.0035
30	0.0009	0.0031
36	0.0007	0.0024
42	0.0006	0.0020
48	0.0005	0.0016
54	0.0004	0.0014
60	0.0004	0.0012
66	0.0004	0.0011
72	0.0003	0.0010
78	0.0003	0.0009
84	0.0003	0.0008
96	0.0002	0.0007

SOURCE:
 City of
 SPRINGDALE
 Arkansas

Table 3.1

Table 3.2

PERMISSIBLE VELOCITIES FOR CHANNELS LINED WITH GRASS

COVER	SLOPE RANGE (PERCENT)	PERMISSIBLE VELOCITY, fps	
		EROSION-RESISTANT SOILS	EASILY ERODED SOILS
Bermuda Grass	0-5	8	6
	5-10	7	5
	>10	6	4
Buffalo grass, Kentucky bluegrass, smooth brome, blue grama	0-5	7	5
	5-10	6	4
	>10	5	3
Grass mixture	0-5	5	4
	5-10	4	3
	Do not use on slopes steeper than 10%		
Lespedeza Sericea, weeping love grass, ischaemum (yellow bluestem), alfalfa, crabgrass	0-5	3.5	2.5
	Do not use on slopes steeper than 5%; except for side slopes in a combination channel		
Annuals - used on mild slopes or as temporary protection until permanent covers are established. Common lespedeza, Sudan grass	0-5	3.5	2.4
	Use on slopes steeper than 3% is not recommended		

REMARKS: The values apply to average, uniform stands of each type of cover.
Use velocities exceeding 5 fps only where good covers and proper maintenance
can be obtained.

SOURCE: AHTD

PERMISSIBLE VELOCITIES FOR
CHANNELS LINED WITH GRASS

Table 3.2

HYDRAULIC DATA FOR PIPE

MATERIAL	N-VALUE
(A) - CONCRETE	
Pre-Cast	0.011 TO 0.013
Cast-in-Place	
Steel forms	0.012 TO 0.013
Wood forms	0.013 TO 0.015
(B) - PLASTIC	
Corrugated polyethylene	0.024 TO 0.026
Corrugated polyethylene (smooth inter.)	0.010 TO 0.012
Polyvinyl chloride (smooth interior)	0.009 TO 0.011
(C) - METAL	sheet 2 of 2

SOURCE:
City of
SPRINGDALE
Arkansas

Table 3.3 (1 of 2)

(C)-CORRUGATED METAL PIPE

PIPE TYPE	PAVEMENT CONDITIONS	ANNULAR CORRUGATIONS		HELICAL CORRUGATIONS	
		DIAM.	CORRUG.	N-VALUE	N-VALUE
CORRUGATED PIPE	UNPAVED 25% PAVED FULLY PAVED	ALL ALL ALL	(2-2/3 X 1/2) (2-2/3 X 1/2) (2-2/3 X 1/2)	CORRUGATION SIZE - (3 X 1)	
				CORRUGATION SIZE - (2-2/3 X 1/2)	
				CORRUGATION SIZE - (1-1/2 X 1/4)	
CORRUGATED PIPE	UNPAVED 25% PAVED FULLY PAVED	ALL ALL ALL	(3 X 1) (3 X 1) (3 X 1)	CORRUGATION SIZE - (3 X 1)	
				CORRUGATION SIZE - (2-2/3 X 1/2)	
				CORRUGATION SIZE - (1-1/2 X 1/4)	
CORRUGATED PIPE	UNPAVED 25% PAVED FULLY PAVED	ALL ALL ALL	(5 X 1) (5 X 1) (5 X 1)	CORRUGATION SIZE - (5 X 1)	
				CORRUGATION SIZE - (3 X 1)	
				CORRUGATION SIZE - (2-2/3 X 1/2)	
STRUCTURAL PLATE PIPE	UNPAVED - - 25% PAVED - -	5-FT 7-FT 10-FT 15-FT 5-FT 7-FT 10-FT 15-FT	(6 X 2) (6 X 2) (6 X 2) (6 X 2) (6 X 2) (6 X 2) (6 X 2)	CORRUGATION SIZE - (6 X 2)	
				CORRUGATION SIZE - (5 X 1)	
				CORRUGATION SIZE - (3 X 1)	
TYPE 1-R SPIRAL RIB	N/A			CORRUGATION SIZE - (3/4 X 3/4 X 7-1/2) ALL DIAMETERS	
				N-VALUE = 0.012	

SOURCE:
City of
SPRINGDALE
Arkansas

Values of K_e for Determining Loss of Head Due to Sudden Enlargement in Pipes, from the Formula

$$H_2 = K_2(V_1^2/2g) \text{ (AISI 1985)}$$

d_2/d_1 = ratio of larger pipe to smaller pipe

V_1 = velocity in smaller pipe

$\frac{d_2}{d_1}$	Velocity, V_1 , in feet per second												
	2	3	4	5	6	7	8	10	12	15	20	30	40
1.2	.11	.10	.10	.10	.10	.10	.10	.09	.09	.09	.09	.09	.08
1.4	.26	.26	.25	.24	.24	.24	.24	.23	.23	.22	.22	.21	.20
1.6	.40	.39	.38	.37	.37	.36	.36	.35	.35	.34	.33	.32	.32
1.8	.51	.49	.48	.47	.47	.46	.46	.45	.44	.43	.42	.41	.40
2.0	.60	.58	.56	.55	.55	.54	.53	.52	.52	.51	.50	.48	.47
2.5	.74	.72	.70	.69	.68	.67	.66	.65	.64	.63	.62	.60	.58
3.0	.83	.80	.78	.77	.76	.75	.74	.73	.72	.70	.69	.67	.65
4.0	.92	.89	.87	.85	.84	.83	.82	.80	.79	.78	.76	.74	.72
5.0	.96	.93	.91	.89	.88	.87	.86	.84	.83	.82	.80	.77	.75
10.0	1.00	.99	.96	.95	.93	.92	.91	.89	.88	.86	.84	.82	.80
∞	1.00	1.00	.98	.96	.95	.94	.93	.91	.90	.88	.86	.83	.81

Source:
City of
SPRINGDALE
Arkansas

HEAD LOSS DUE TO
SUDDEN ENLARGEMENT

Values of K_2 for Determining Loss of Head Due
to Gradual Enlargement in Pipes from the Formula

$$H_2 = K_2(V_1^2/2g) \text{ (AISI 1985)}$$

d_2/d_1 = ratio of diameter of larger pipe to diameter of smaller pipe. Angle of cone is twice the angle between the axis of the cone and its side.

$\frac{d_2}{d_1}$	Angle of cone													
	2°	4°	6°	8°	10°	15°	20°	25°	30°	35°	40°	45°	50°	60°
1.1	.01	.01	.01	.02	.03	.05	.10	.13	.16	.18	.19	.20	.21	.23
1.2	.02	.02	.02	.03	.04	.09	.16	.21	.25	.29	.31	.33	.35	.37
1.4	.02	.03	.03	.04	.06	.12	.23	.30	.36	.41	.44	.47	.50	.53
1.6	.03	.03	.04	.05	.07	.14	.26	.35	.42	.47	.51	.54	.57	.61
1.8	.03	.04	.04	.05	.07	.15	.28	.37	.44	.50	.54	.58	.61	.65
2.0	.03	.04	.04	.05	.08	.16	.29	.38	.46	.52	.56	.60	.63	.68
2.5	.03	.04	.04	.05	.08	.16	.30	.39	.48	.54	.58	.62	.65	.70
3.0	.03	.04	.04	.05	.08	.16	.31	.40	.48	.55	.59	.63	.66	.71
∞	.03	.04	.05	.06	.08	.16	.31	.40	.49	.56	.60	.64	.67	.72

SOURCE:
City of
SPRINGDALE
Arkansas

HEAD LOSS DUE TO
GRADUAL ENLARGEMENT

Values of K_3 for Determining Loss of Head Due to Sudden Contraction from the Formula

$$H_3 = K_3(V_2^2/2g) \text{ (AISI 1985)}$$

d_2/d_1 = ratio of larger to smaller diameter

V_2 = velocity in smaller pipe

$\frac{d_2}{d_1}$	Velocity, V_2 , in feet per second												
	2	3	4	5	6	7	8	10	12	15	20	30	40
1.1	.03	.04	.04	.04	.04	.04	.04	.04	.04	.04	.05	.05	.06
1.2	.07	.07	.07	.07	.07	.07	.07	.08	.08	.08	.09	.10	.11
1.4	.17	.17	.17	.17	.17	.17	.17	.18	.18	.18	.18	.19	.20
1.6	.26	.26	.26	.26	.26	.26	.26	.26	.26	.25	.25	.25	.24
1.8	.34	.34	.34	.34	.34	.34	.33	.33	.32	.32	.31	.29	.27
2.0	.38	.38	.37	.37	.37	.37	.36	.36	.35	.34	.33	.31	.29
2.2	.40	.40	.40	.39	.39	.39	.39	.38	.37	.37	.35	.33	.30
2.5	.42	.42	.42	.41	.41	.41	.40	.40	.39	.38	.37	.34	.31
3.0	.44	.44	.44	.43	.43	.43	.42	.42	.41	.40	.39	.36	.33
4.0	.47	.46	.46	.46	.45	.45	.45	.44	.43	.42	.41	.37	.34
5.0	.48	.48	.47	.47	.47	.46	.46	.45	.45	.44	.42	.38	.35
10.0	.49	.48	.48	.48	.48	.47	.47	.46	.46	.45	.43	.40	.36
∞	.49	.49	.48	.48	.48	.47	.47	.47	.46	.45	.44	.41	.38

SOURCE
City of
SPRINGDALE
Arkansas

HEAD LOSS DUE TO
SUDDEN CONTRACTION

Table 3.6

HEAD LOSS COEFFICIENTS DUE TO OBSTRUCTIONS			
$\frac{A^*}{A}$	K_j	A.	K_j
1.05	0.10	3.0	15.0
1.1	0.21	4.0	27.3
1.2	0.50	5.0	42.0
1.4	1.15	6.0	57.0
1.6	2.40	7.0	72.5
1.8	4.00	8.0	88.0
2.0	5.55	9.0	104.0
2.2	7.05	10.0	121.0
2.5	9.70		

* $\frac{A}{A}$ = Ratio of area of pipe to opening at obstruction.
A.

Source: City of Waco, Texas, Storm Drainage Design Manual

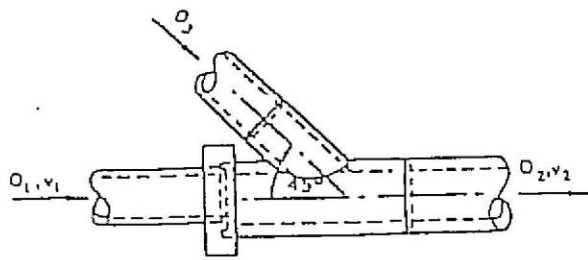

PLAN

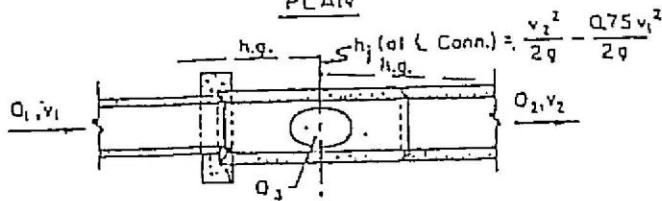

SECTION

CASE V

45° WYE CONNECTION
OR CUT IN

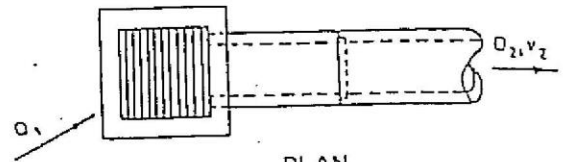

PLAN

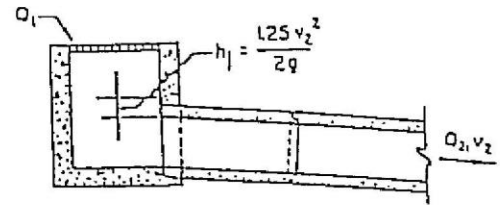

SECTION

CASE VI

INLET OR MANHOLE AT
BEGINNING OF LINE

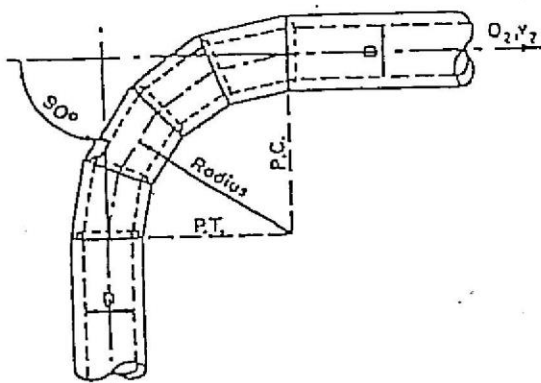

CASE VII

CONDUIT ON 90° CURVES *

NOTE: Head loss applied at P.C. for length of curve.

Radius = Dia. of Pipe $h_j = 0.50 \frac{v_2^2}{2g}$

Radius = (2-10) Dia. of Pipe $h_j = 0.25 \frac{v_2^2}{2g}$

Radius = (10-20) Dia. of Pipe $h_j = 0.10 \frac{v_2^2}{2g}$

Radius = Greater than 20 Dia. of Pipe $h_j = 0$

*When curves other than 90° are used, apply the following factors to 90° curves.

60° curve 85%

45° curve 70%

22½° curve 40%

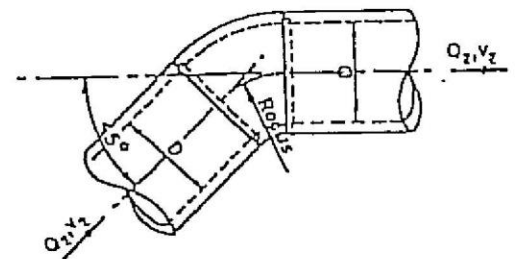

CASE VIII

BENDS WHERE RADIUS IS
EQUAL TO DIAMETER OF PIPE

NOTE: Head loss applied at beginning of bend

90° Bend $h_j = 0.50 \frac{v_2^2}{2g}$

60° Bend $h_j = 0.43 \frac{v_2^2}{2g}$

45° Bend $h_j = 0.35 \frac{v_2^2}{2g}$

22½° Bend $h_j = 0.20 \frac{v_2^2}{2g}$

SOURCE: City of Austin, Tx.

MINOR HEAD LOSSES DUE TO
TURBULENCE AT STRUCTURES

Figure 3.1

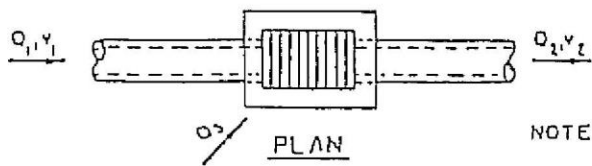

NOTE For Any Type of Inlet.

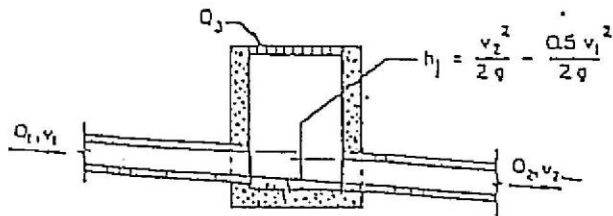
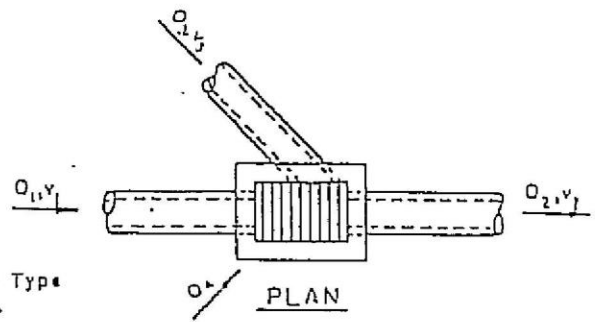

CASE I

INLET ON MAIN LINE

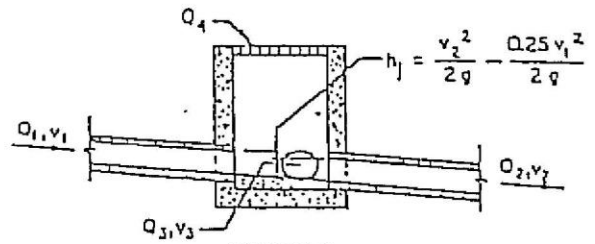

CASE II

INLET ON MAIN LINE WITH BRANCH LATERAL

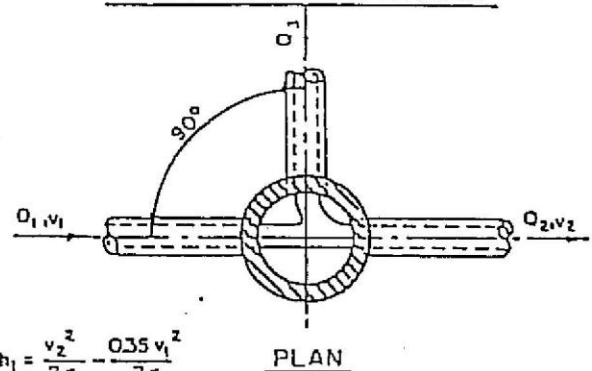
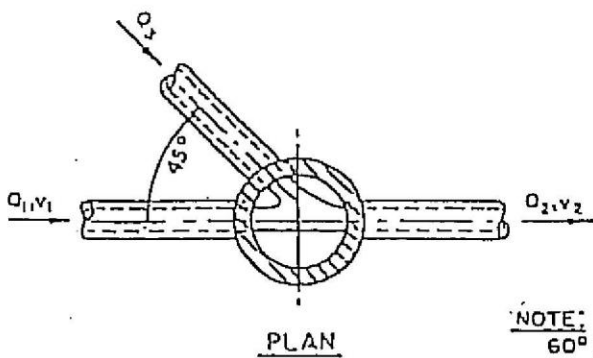

NOTE:

$$60^\circ \text{ Lateral } h_j = \frac{v_2^2}{2g} - \frac{0.35 v_1^2}{2g}$$

$$22\frac{1}{2}^\circ \text{ Lateral } h_j = \frac{v_2^2}{2g} - \frac{0.75 v_1^2}{2g}$$

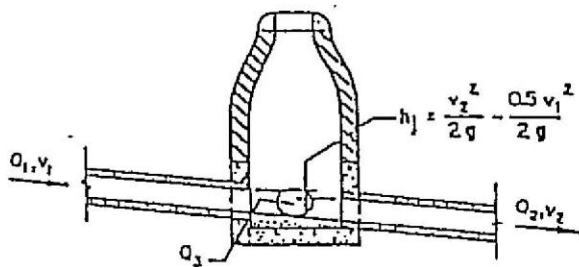

CASE III

MANHOLE ON MAIN LINE WITH 45° BRANCH LATERAL

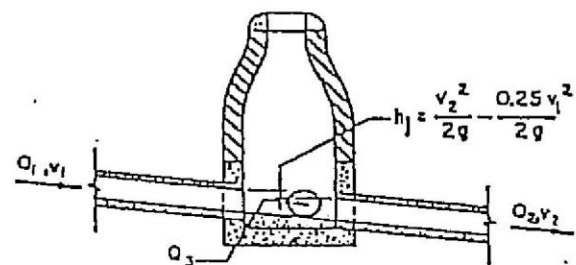

CASE IV

MANHOLE ON MAIN LINE WITH 90° BRANCH LATERAL

SOURCE: City of Austin, Tx.

MINOR HEAD LOSSES DUE TO TURBULENCE AT STRUCTURES

Figure 3.2

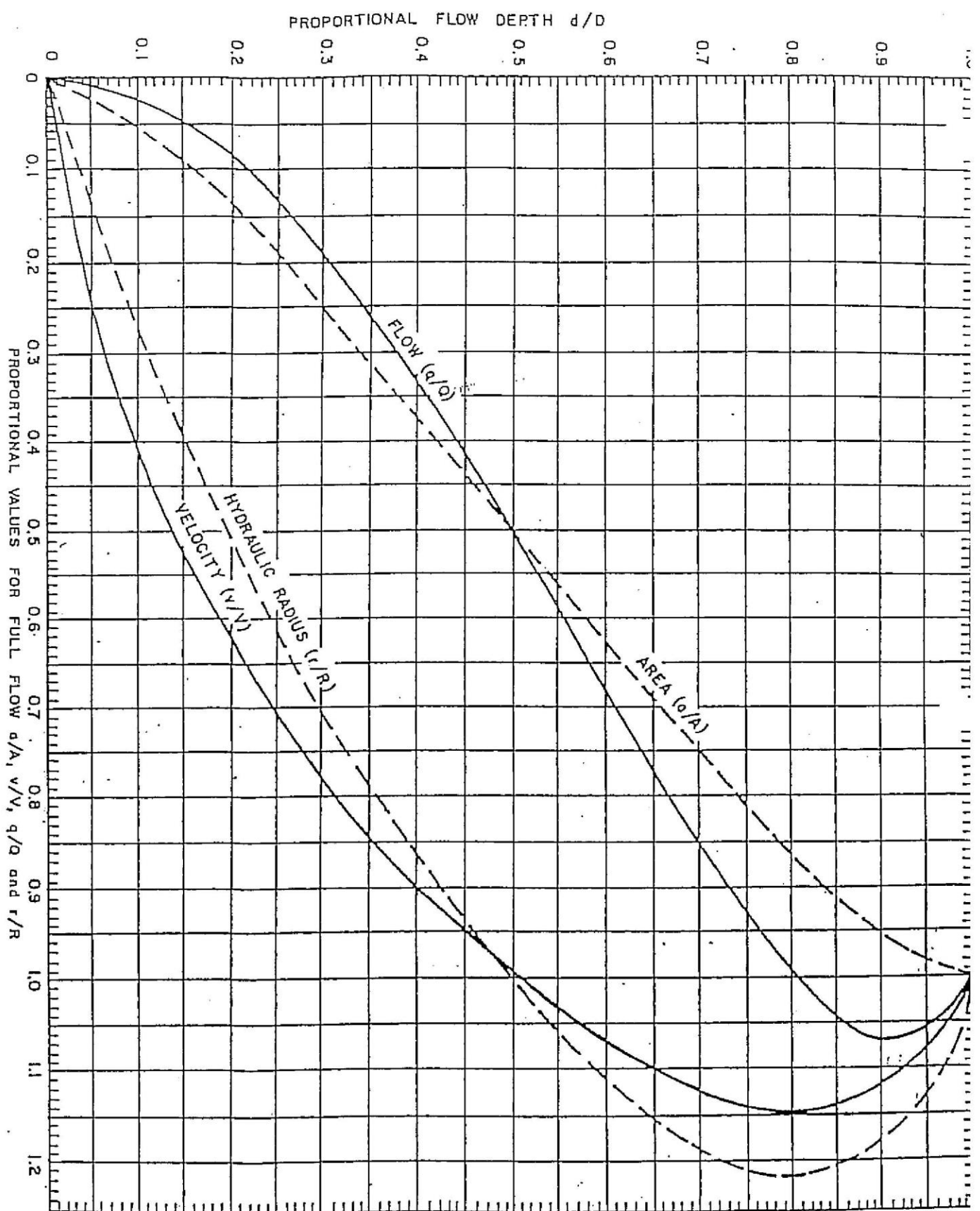

Source:
City of
SPRINGDALE
Arkansas

RELATIVE VELOCITY, AREA, AND DISCHARGE
IN A CIRCULAR PIPE FOR ANY DEPTH OF FLOW

Figure 3.3

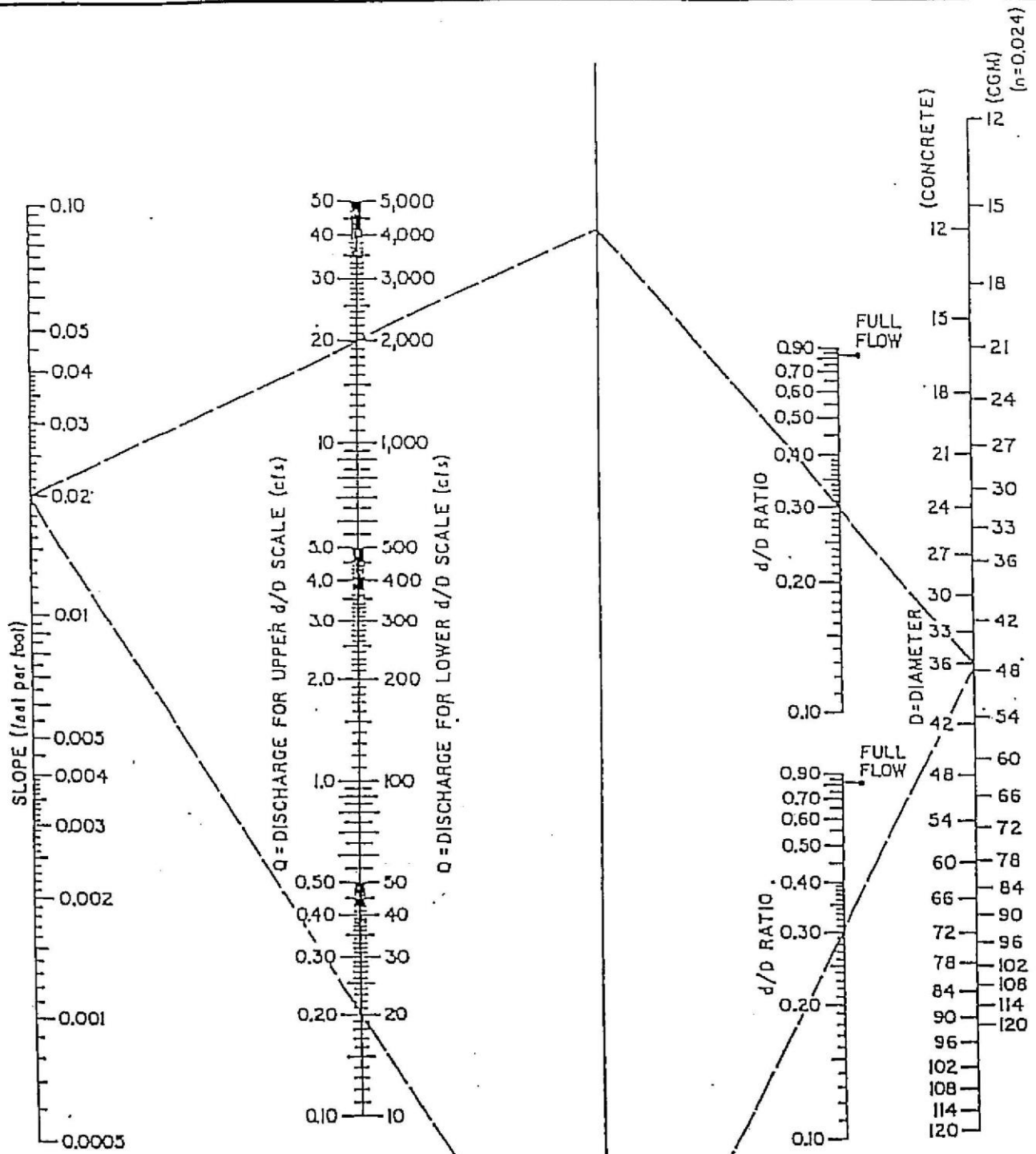

EXAMPLE
 GIVEN: $S = 0.02$ FIND: $d/D =$
 $Q = 20 \text{ cfs}$ $d =$
 $D = 36'' \text{ (CONCRETE)}$

SOLUTION
 $d/D = 0.30$
 $d = 0.30 \times 3' = 0.9'$

SOURCE: AHTD

UNIFORM FLOW FOR PIPE CULVERTS

Figure 3.4

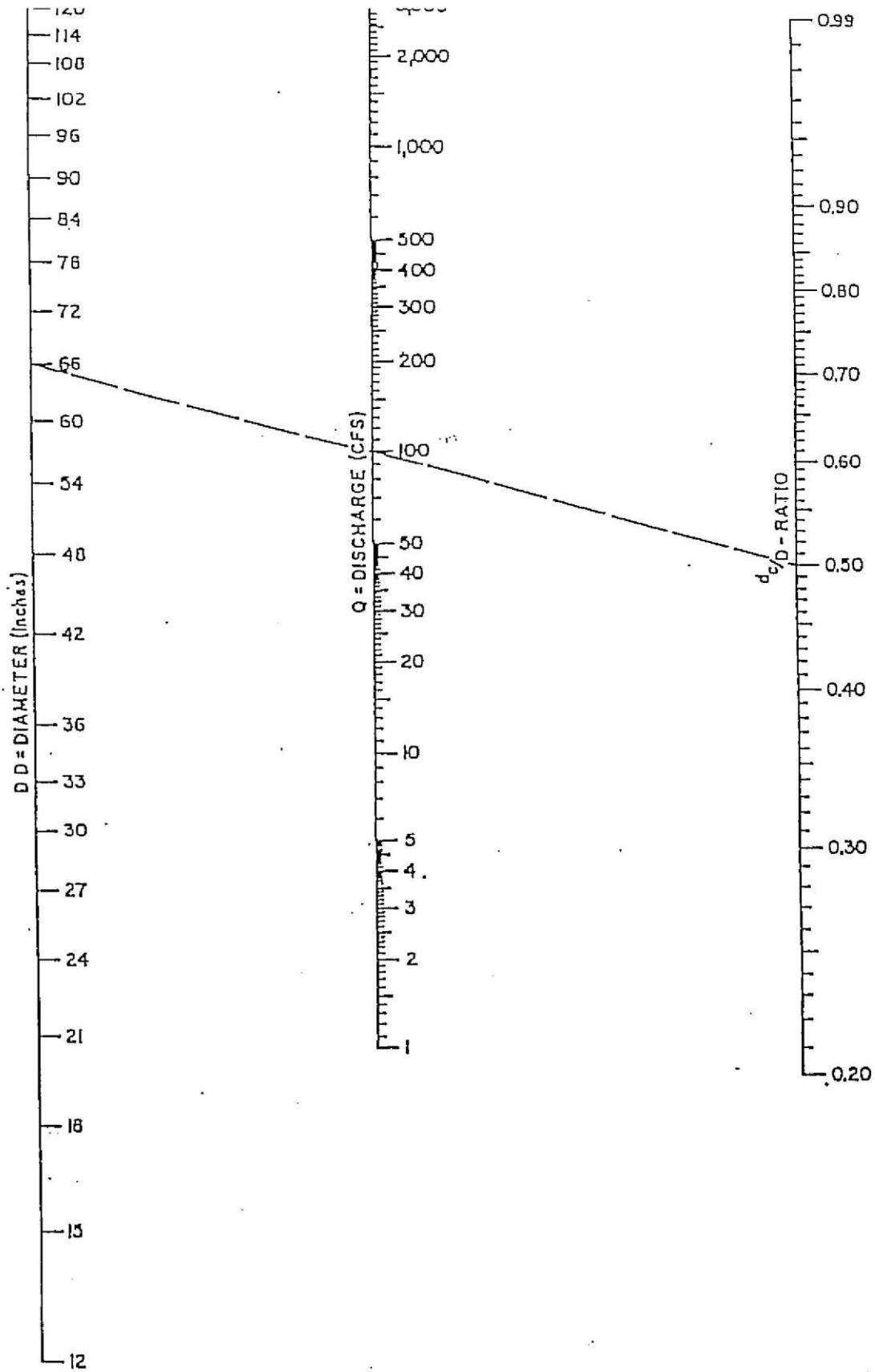

CRITICAL DEPTH OF FLOW FOR CIRCULAR CONDUITS
 SOURCE: AHTD

Figure 3.5

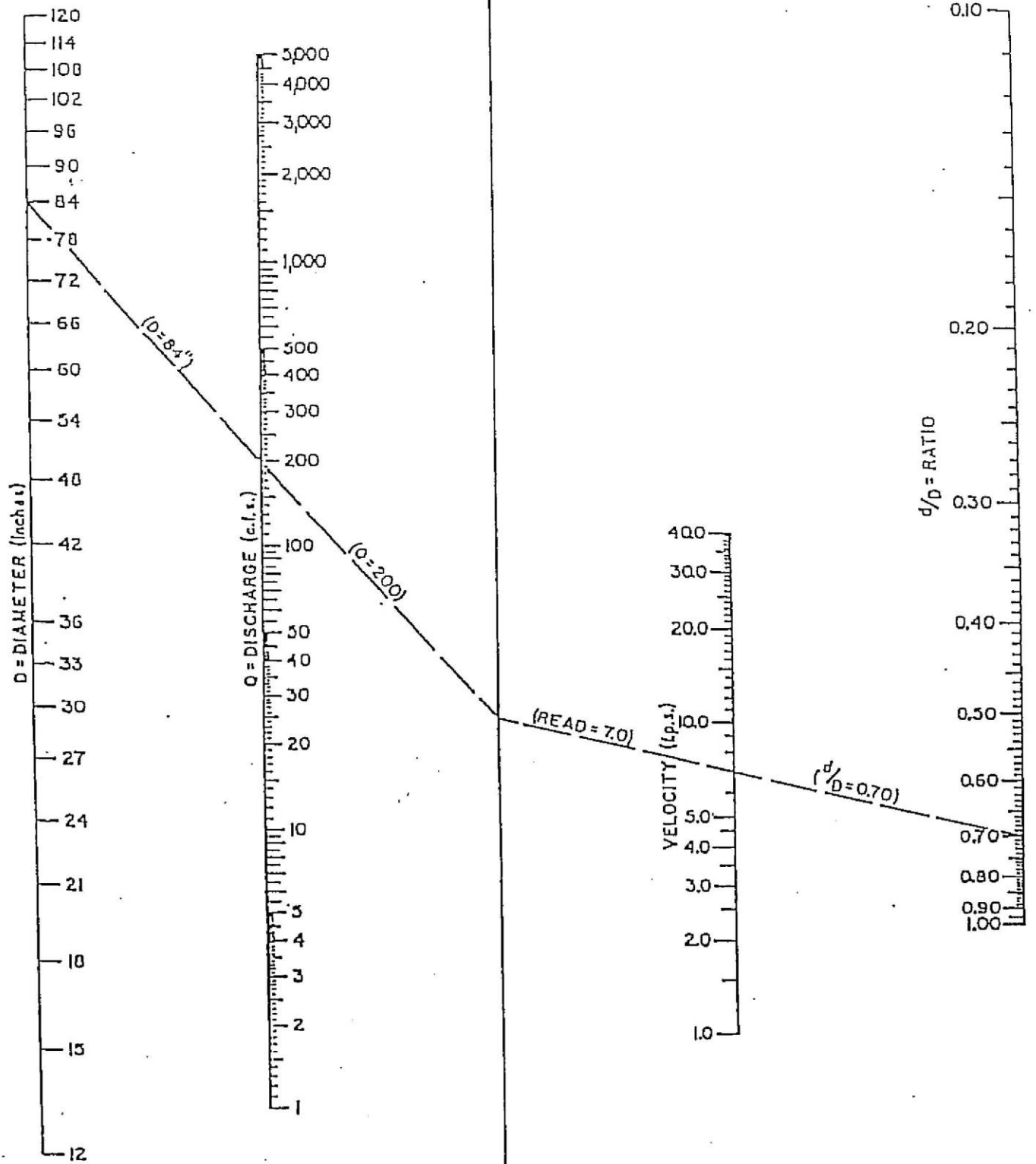

SOURCE:
City of
SPRINGDALE
Arkansas

VELOCITY IN PIPE CONDUITS

Figure 3.6

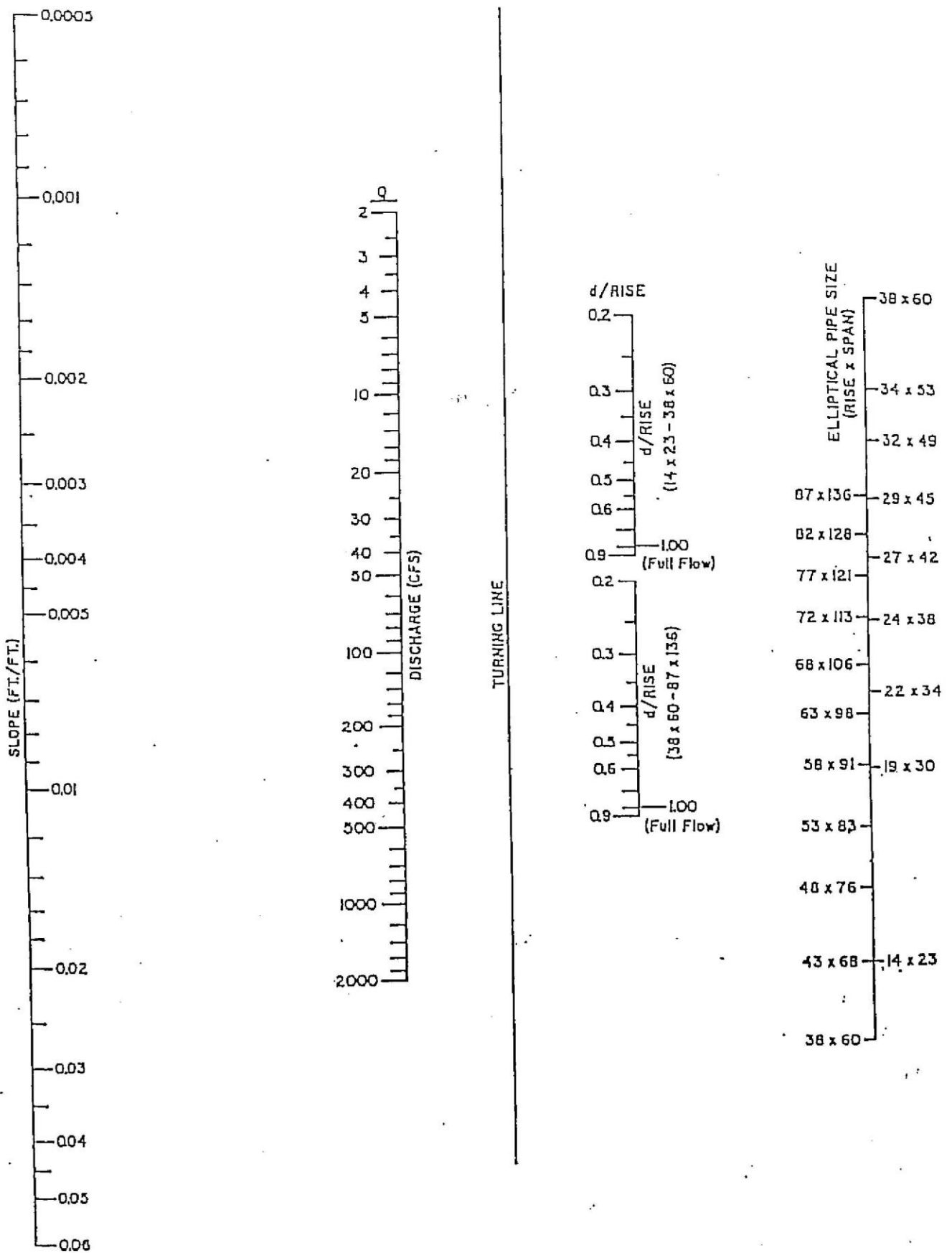

SOURCE:
City of
SPRINGDALE
Arkansas

UNIFORM FLOW FOR CONCRETE ELLIPTICAL PIPE

Figure 3.7

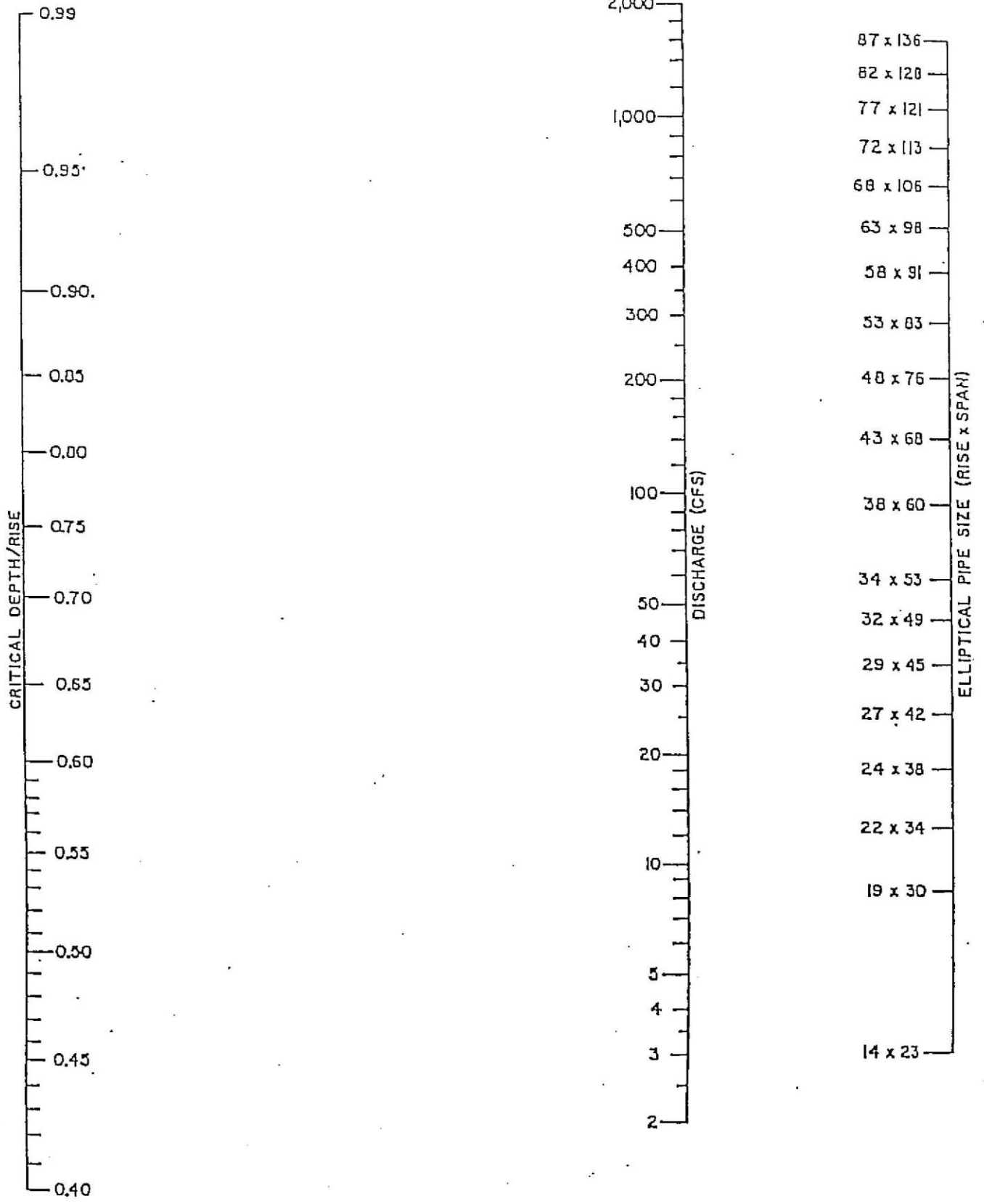

Source:
City of
SPRINGDALE
Arkansas

CRITICAL DEPTH FOR ELLIPTICAL PIPE

Figure 3.8

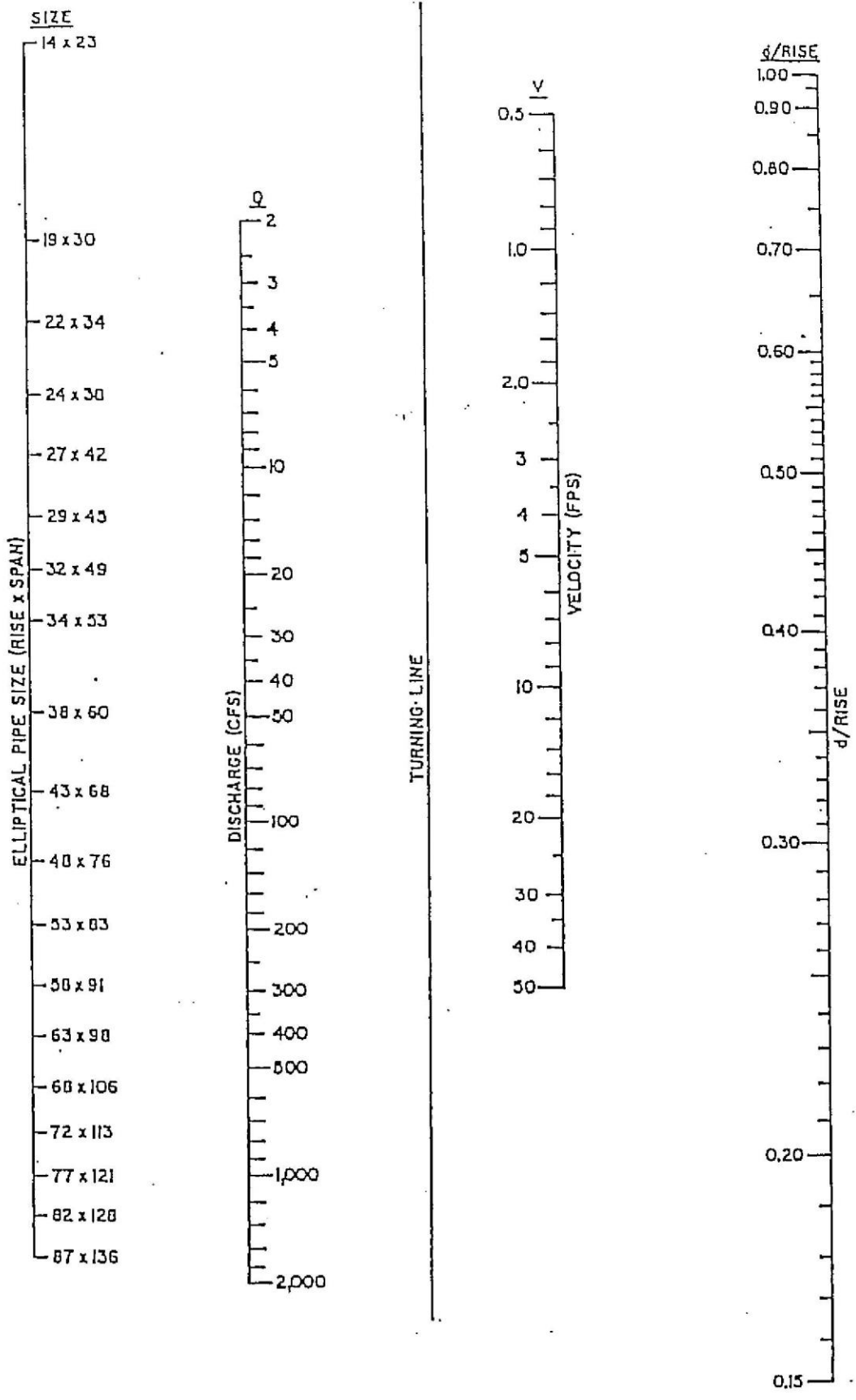

SOURCE:
City of
SPRINGDALE
Arkansas

VELOCITY IN ELLIPTICAL PIPE

Figure 3.9

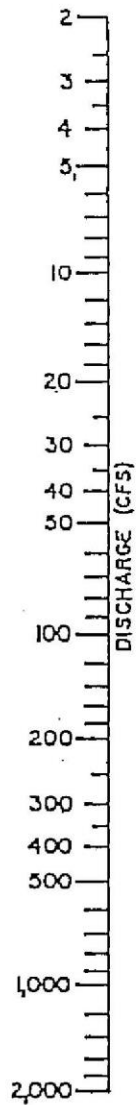
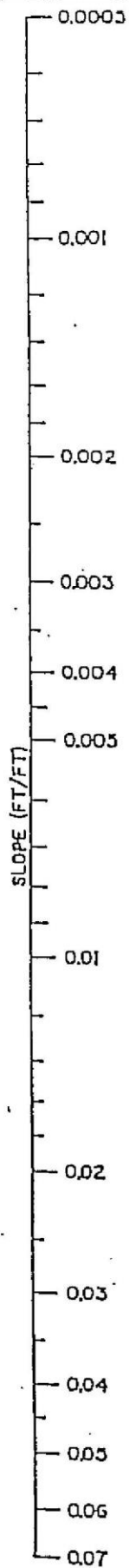

TURNING LINE

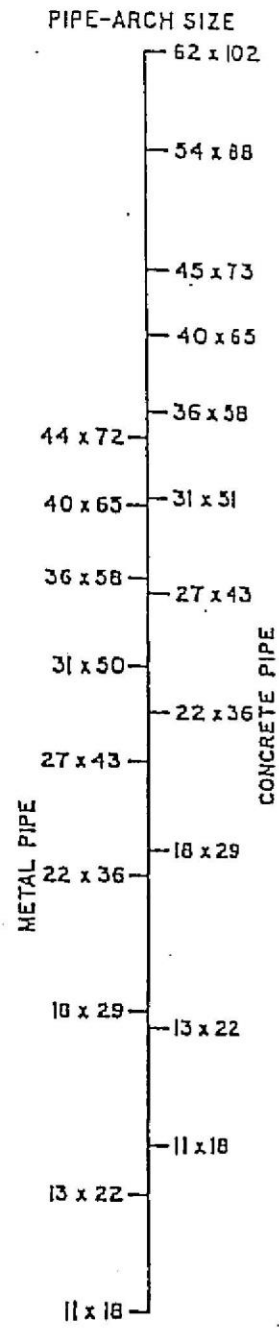
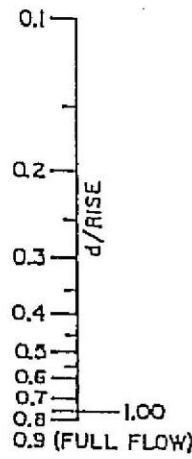

SOURCE:
City of
SPRINGDALE
Arkansas

UNIFORM FLOW FOR ARCH PIPE

Figure 3.10

PIPE-ARCH SIZE (RISE x SPAN)

- 62x102
- 54x88
- 45x73
- 40x65
- 36x58
- 31x51
- 27x43
- 22x36
- 18x29
- 18x22
- 11x18

DISCHARGE (cfs)

- 1,000
- 500
- 400
- 300
- 200
- 100
- 50
- 40
- 30
- 20
- 10
- 5
- 4
- 3
- 2

CRITICAL DEPTH/RISE

- 0.99
- 0.95
- 0.90
- 0.80
- 0.70
- 0.60
- 0.50
- 0.40
- 0.30

Source:
City of
SPRINGDALE
Arkansas

CRITICAL DEPTH OF FLOW
FOR ARCH PIPE

Figure 3.11

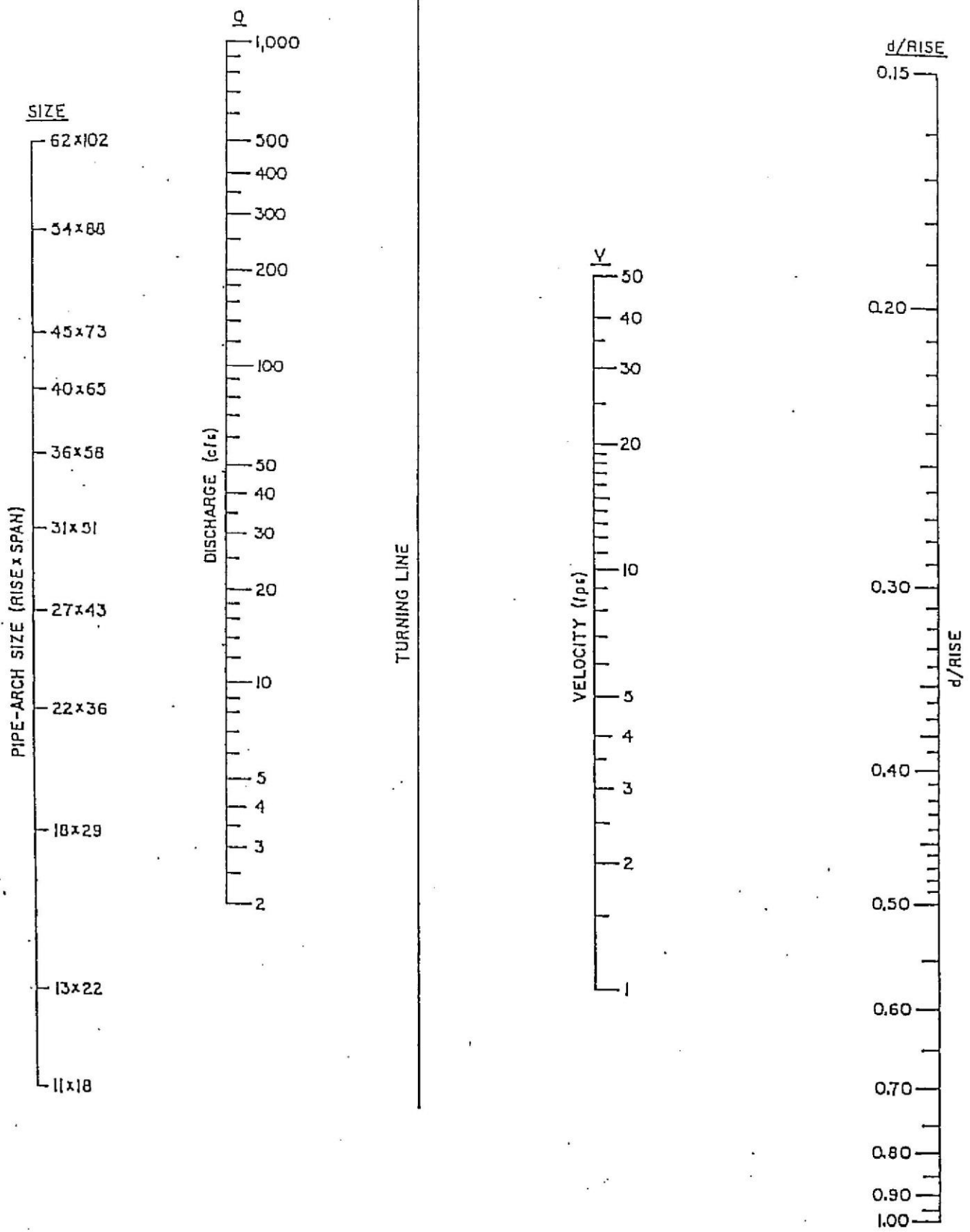

Source:
City of
SPRINGDALE
Arkansas

VELOCITY IN ARCH PIPE

Figure 3.12

ADD DRAWING that shows pipe

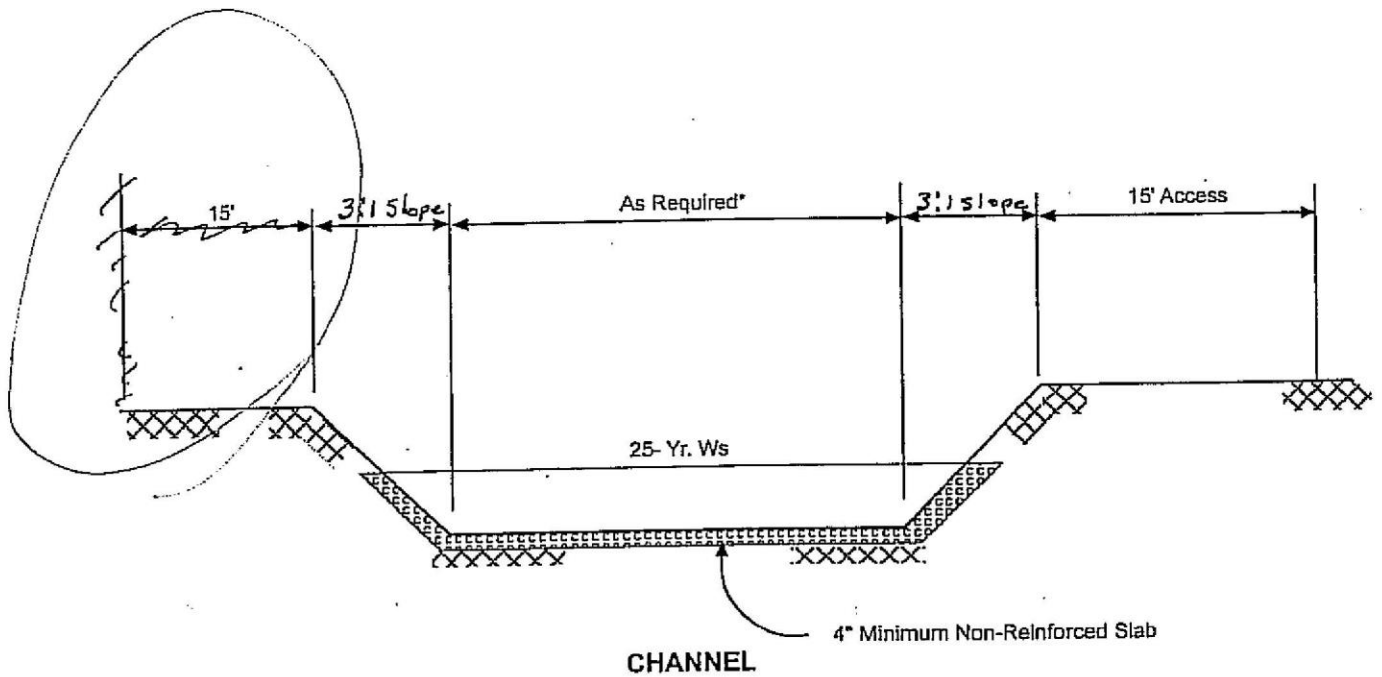

GENERAL NOTES

- Access easements required every 600'
- Utilities shall not be located beneath a concrete bottom except at crossings and a minimum cover of 3' will be provided
- Manholes not allowed in ditches

SOURCE:
City of
SPRINGDALE
Arkansas

MINIMUM DRAINAGE
EASEMENTS REQUIREMENTS
MINIMUM EASEMENTS
FOR
DRAINAGE AND UTILITIES

Figure 3.1:

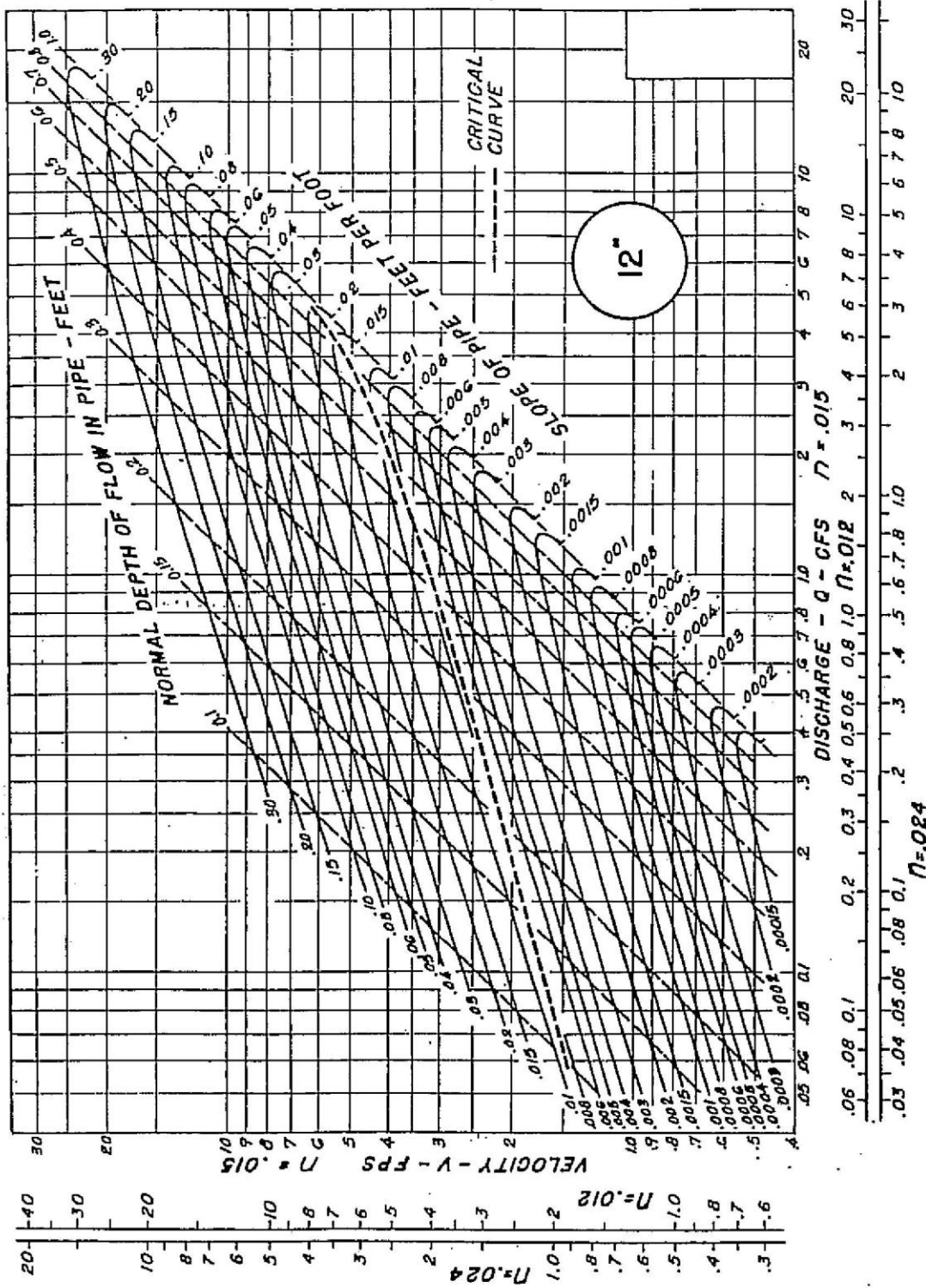

Source: Figures 3.14 to 3.26
 U.S. Department of Transportation
 Federal Highway Administration
 Design Charts for Open Channel Flow

PIPE FLOW CHART
 12-INCH DIAMETER

Figure 3.14

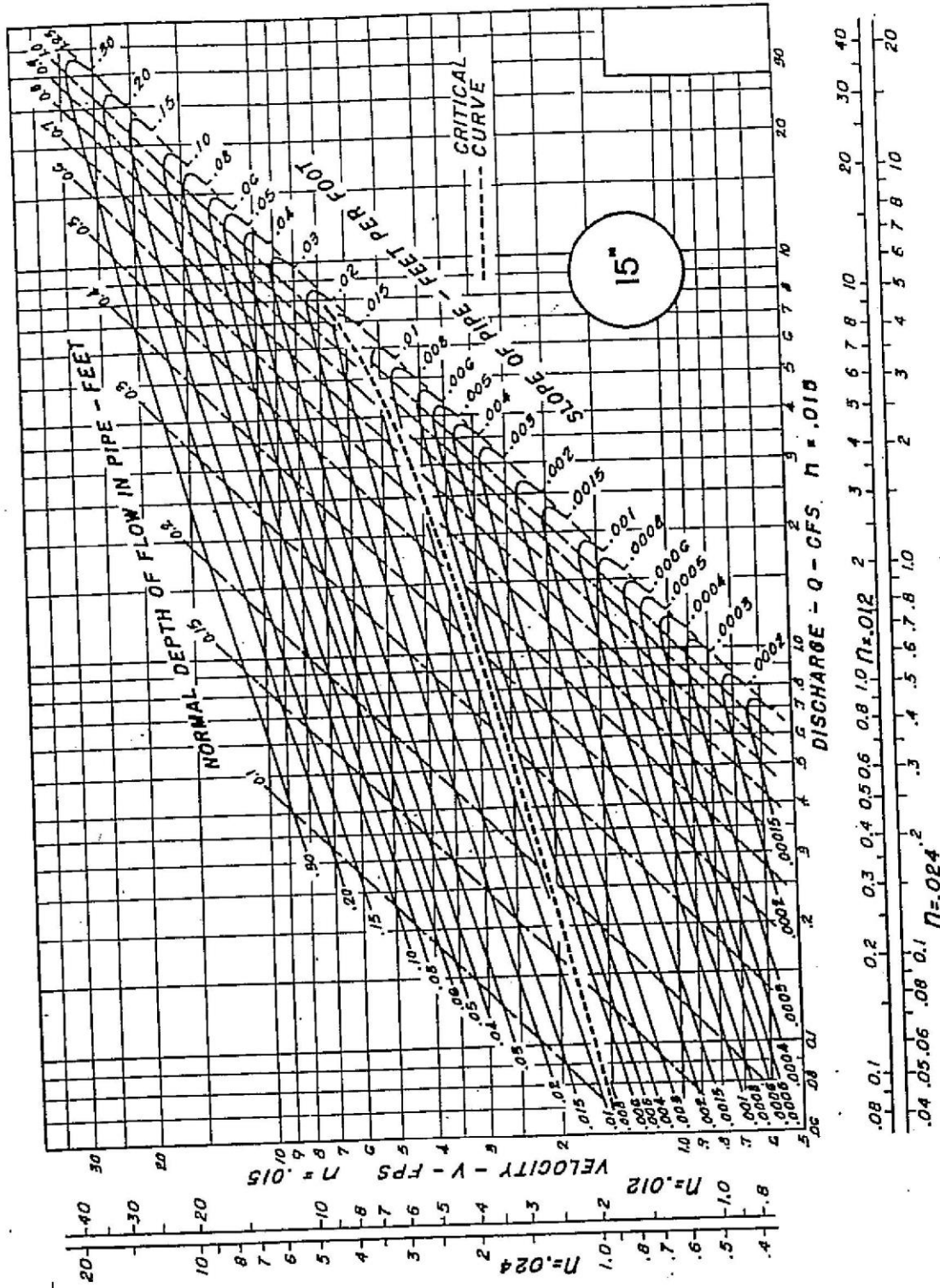

PIPE FLOW CHART
15 INCH DIAMETER

Figure 3.15

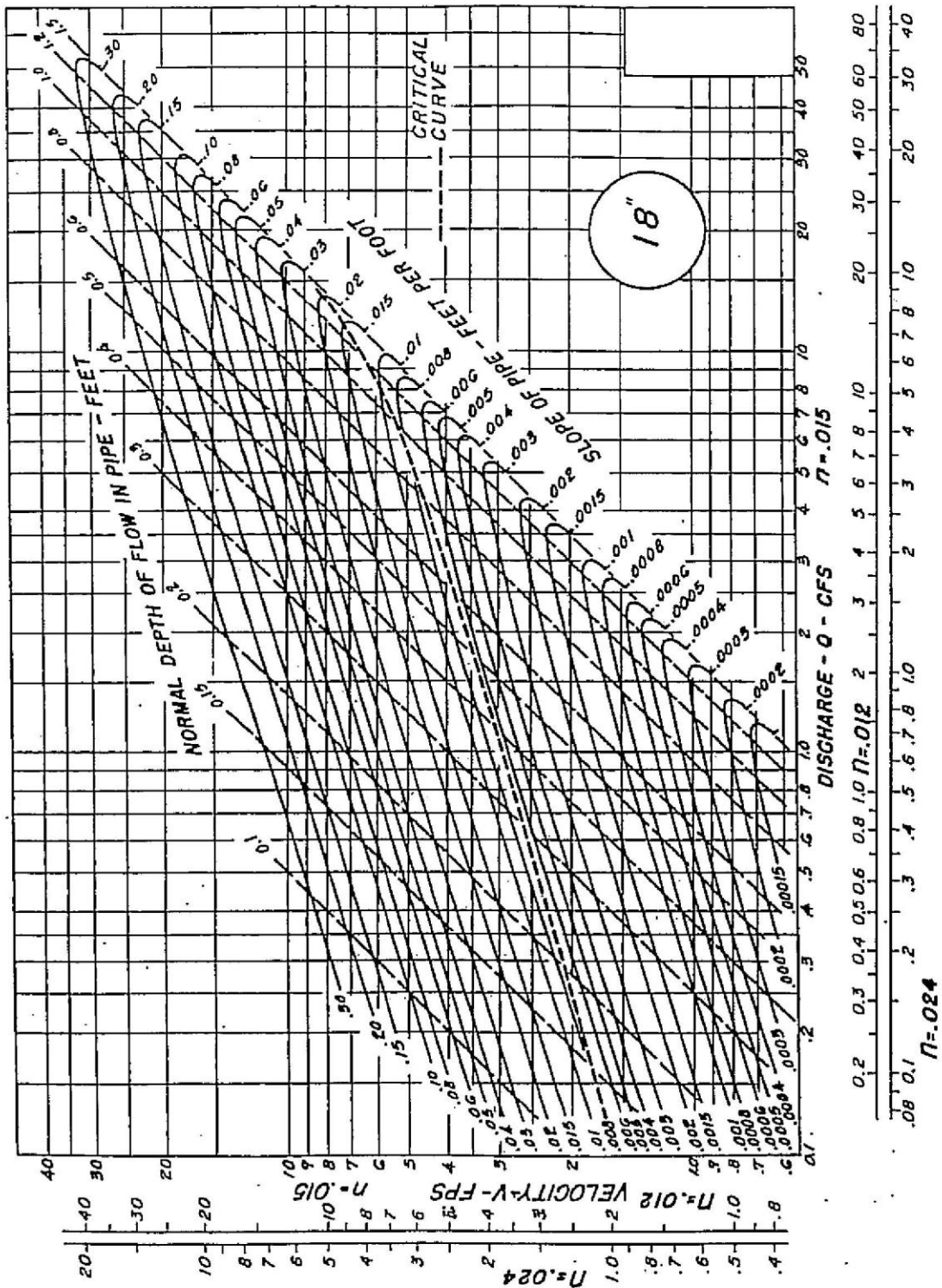

PIPE FLOW CHART
18 INCH DIAMETER

Figure 3.16

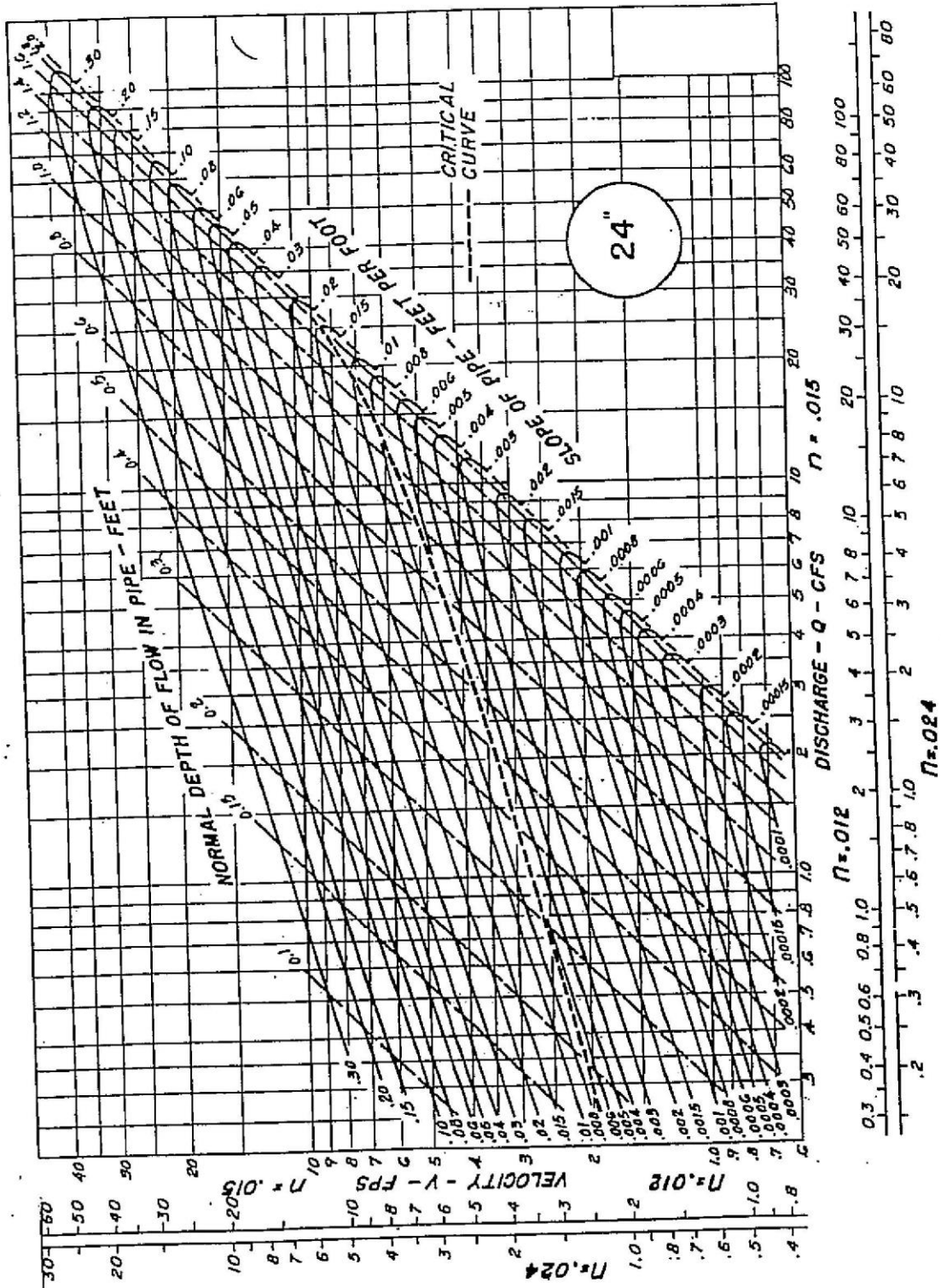

PIPE FLOW CHART
24 INCH DIAMETER

Figure 3.17

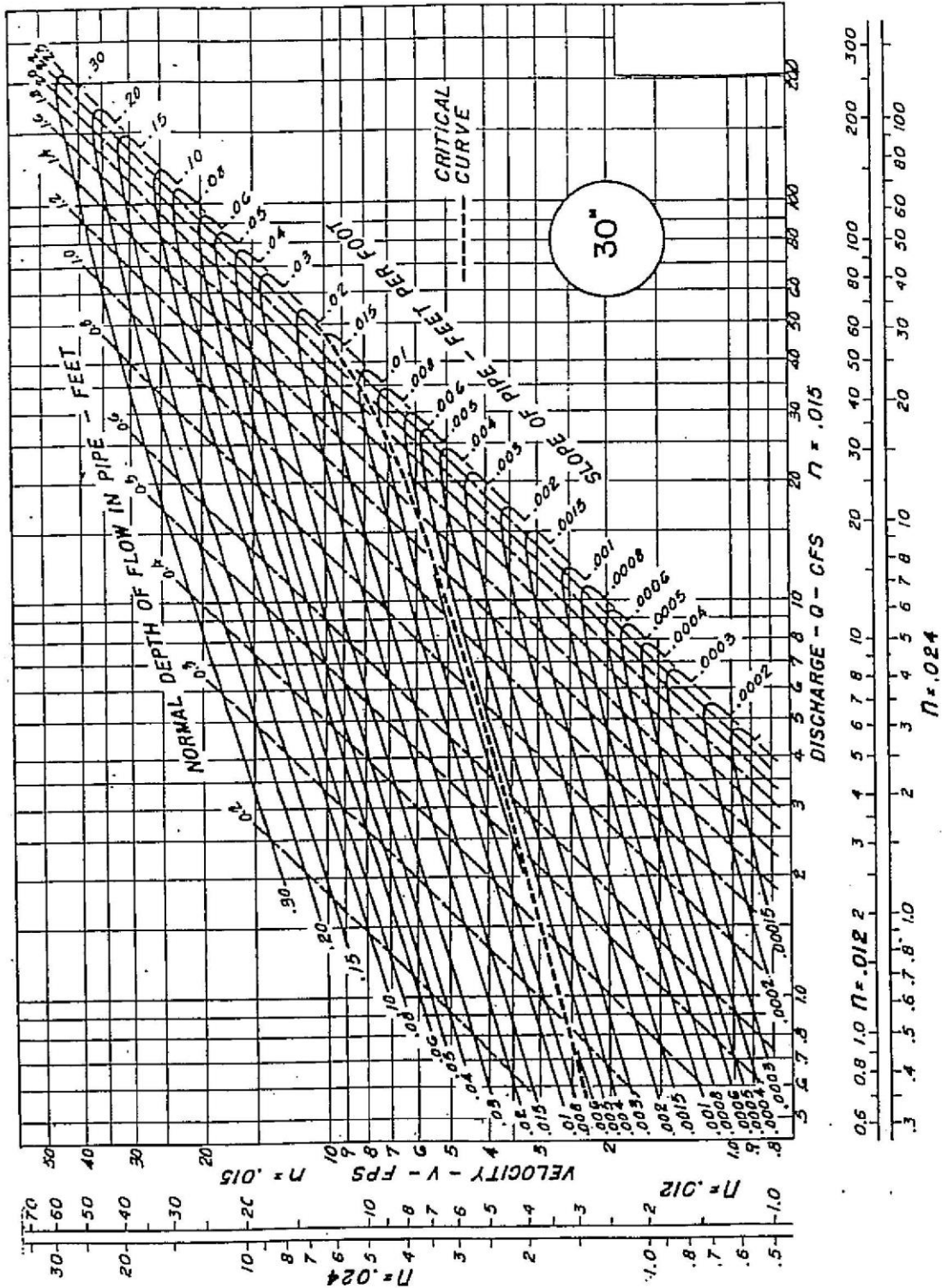

PIPE FLOW CHART
30 INCH DIAMETER

Figure 3.18

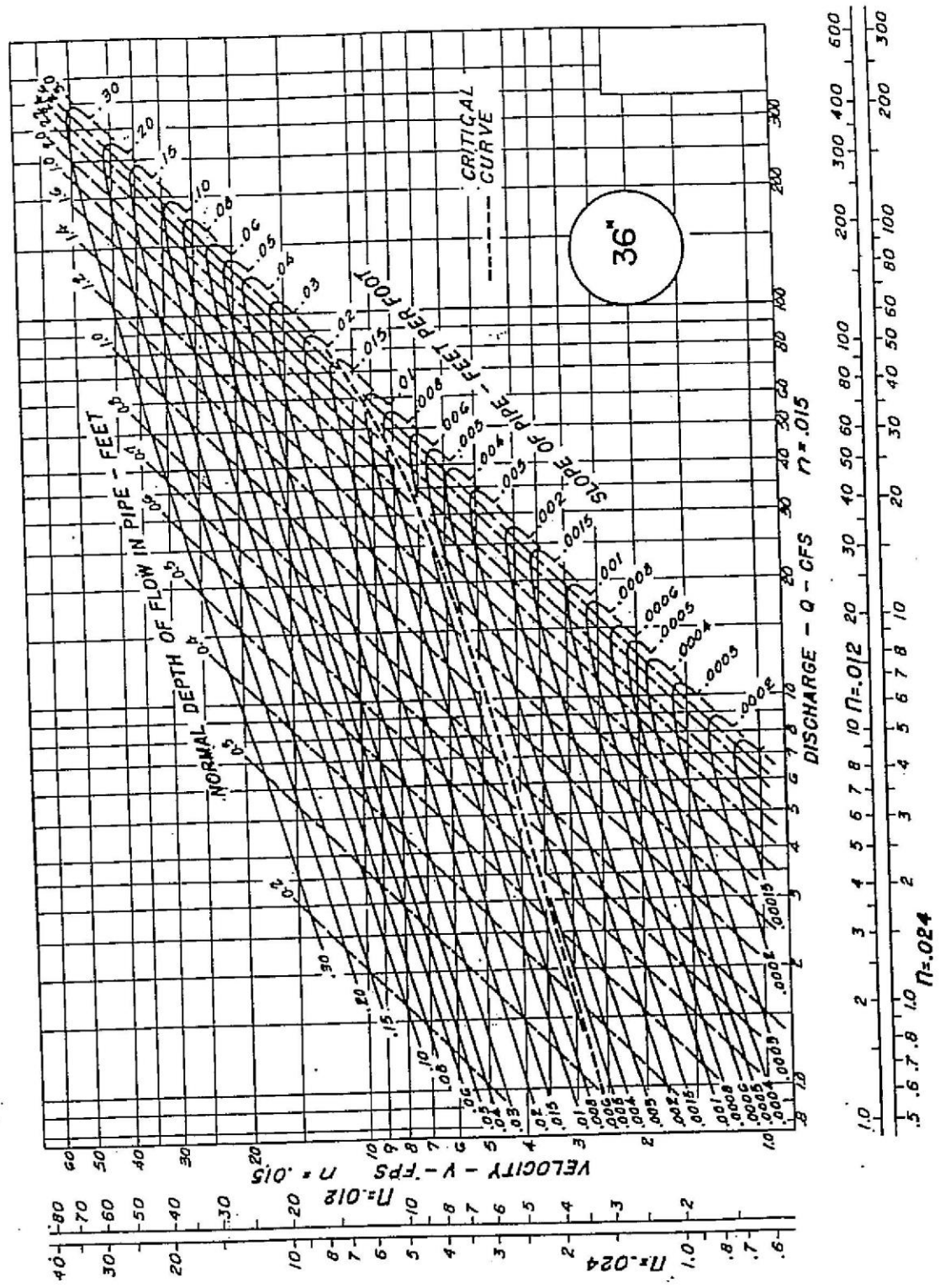

PIPE FLOW CHART
36 INCH DIAMETER

Figure 3.19

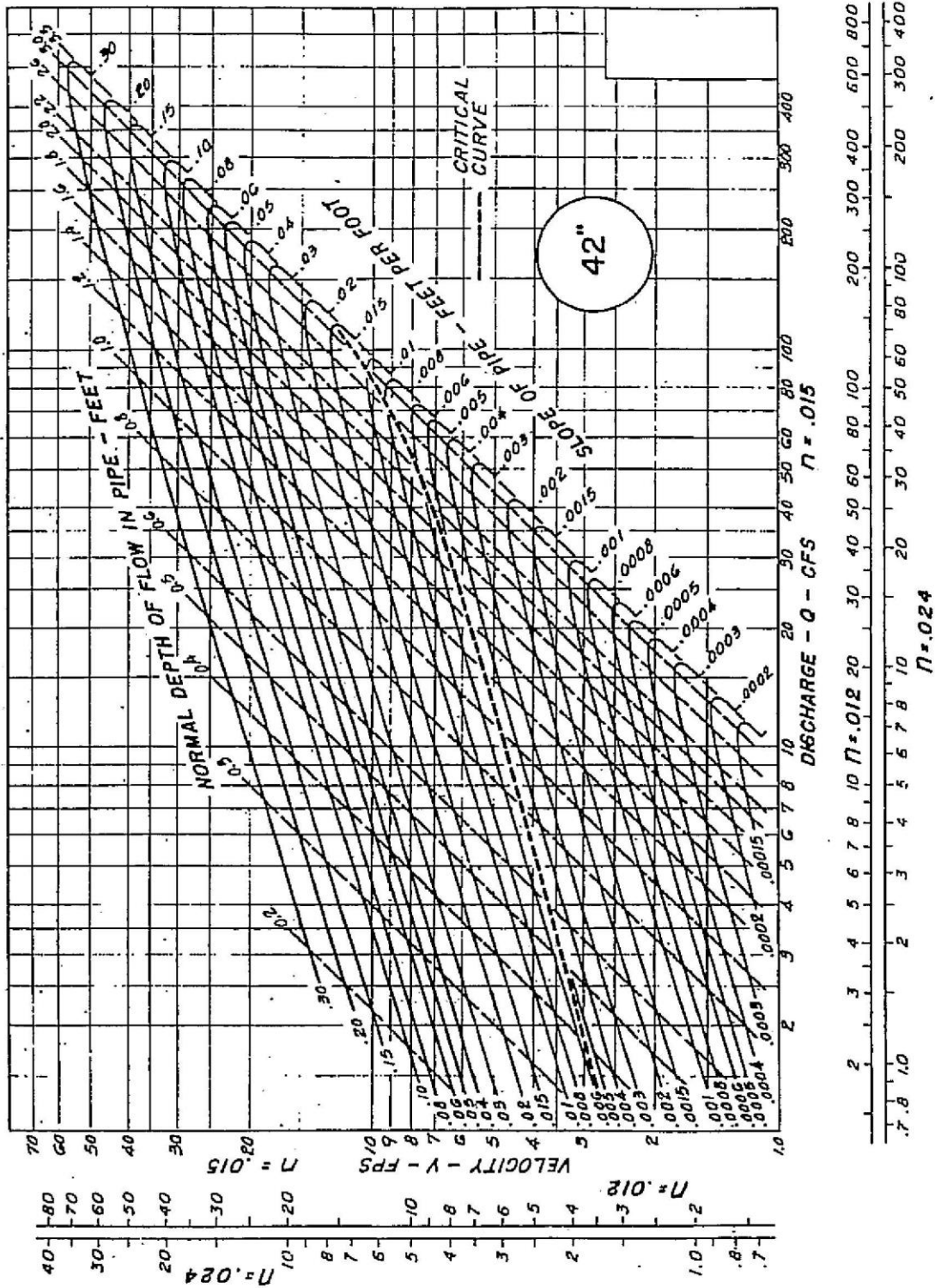

PIPE FLOW CHART
42 INCH DIAMETER

Figure 3.20

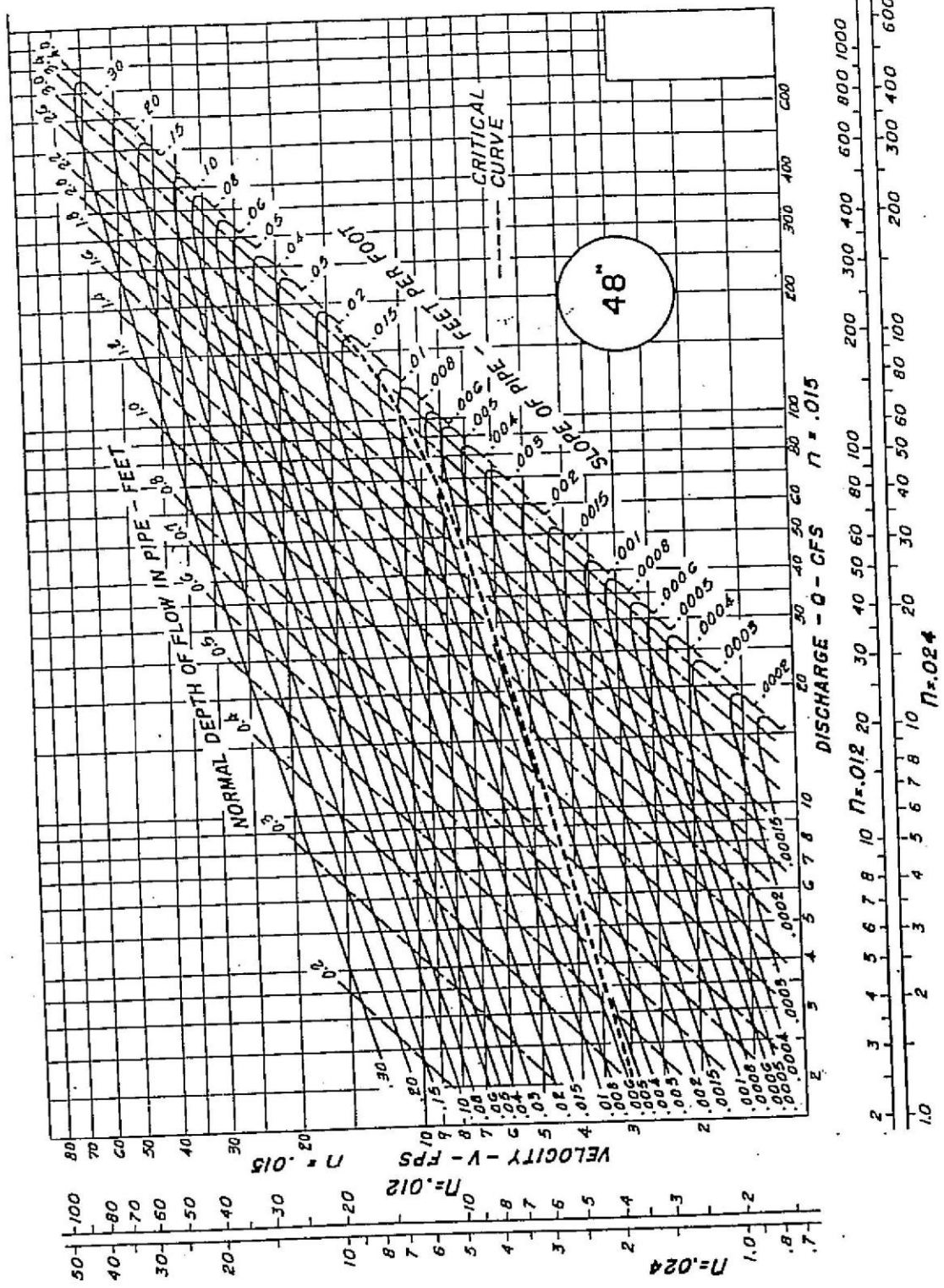

PIPE FLOW CHART
48 INCH DIAMETER

Figure 3.21

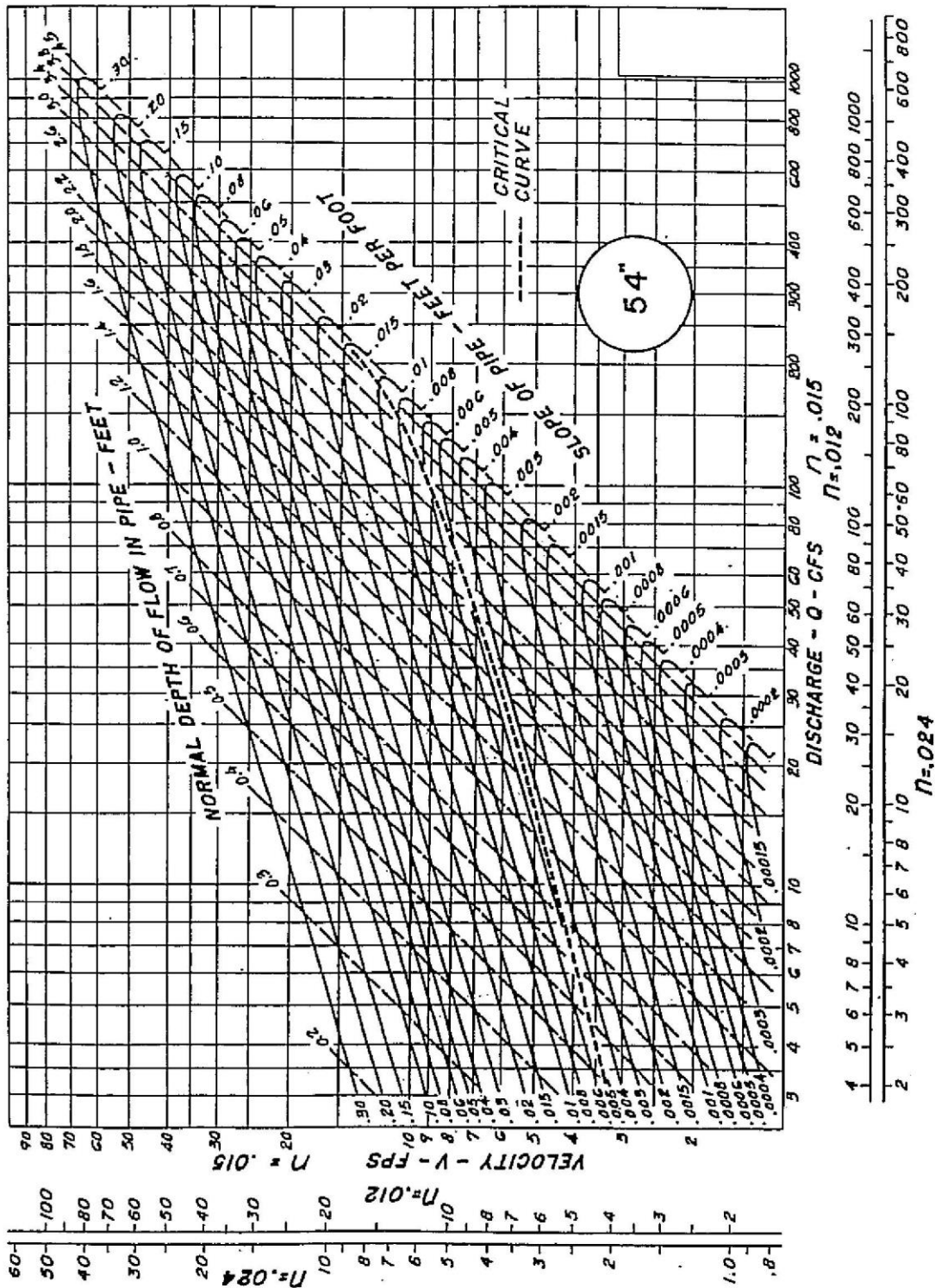

PIPE FLOW CHART
54 INCH DIAMETER

Figure 3.22

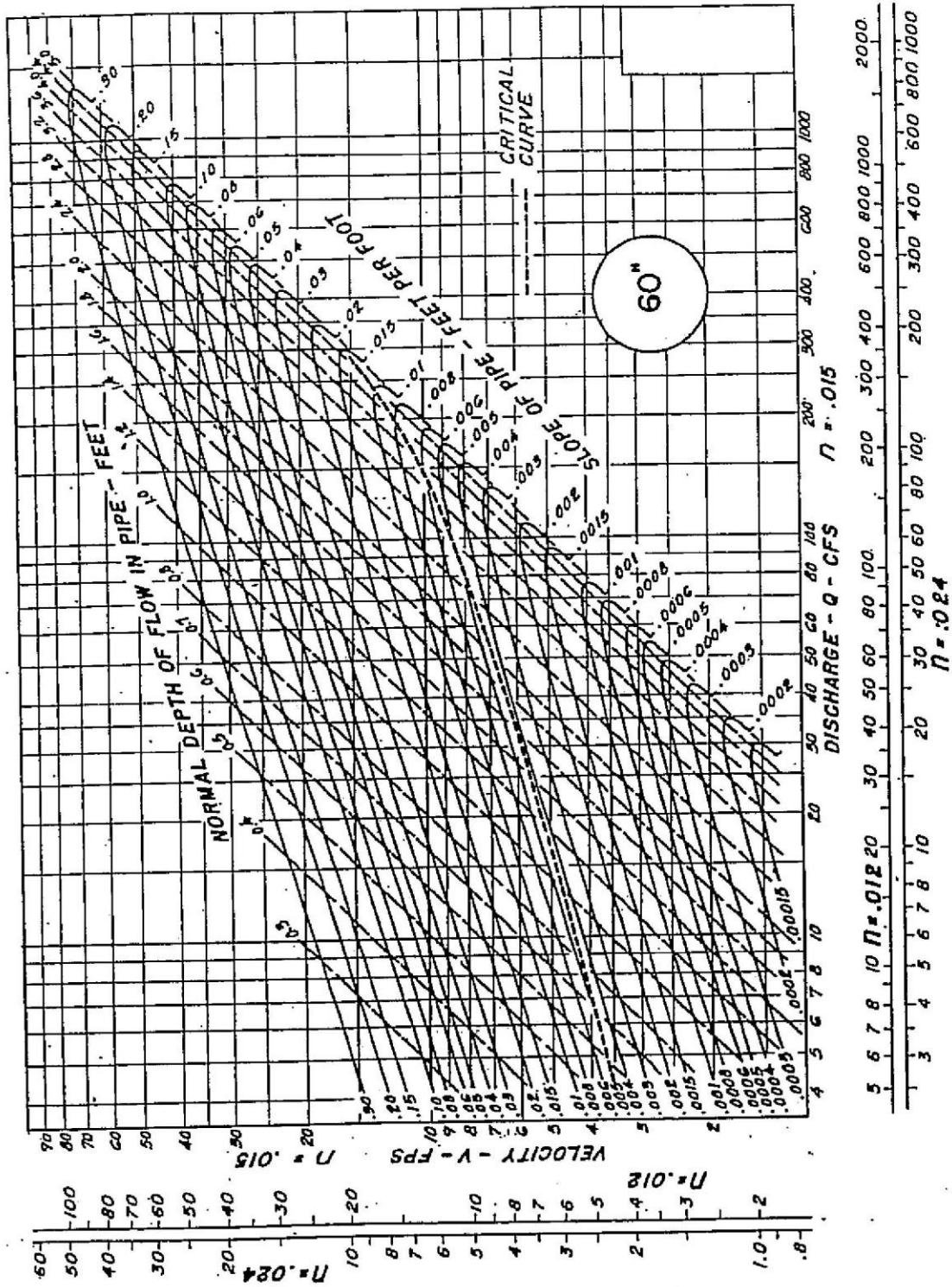

PIPE FLOW CHART
60 INCH DIAMETER

Figure 3.23

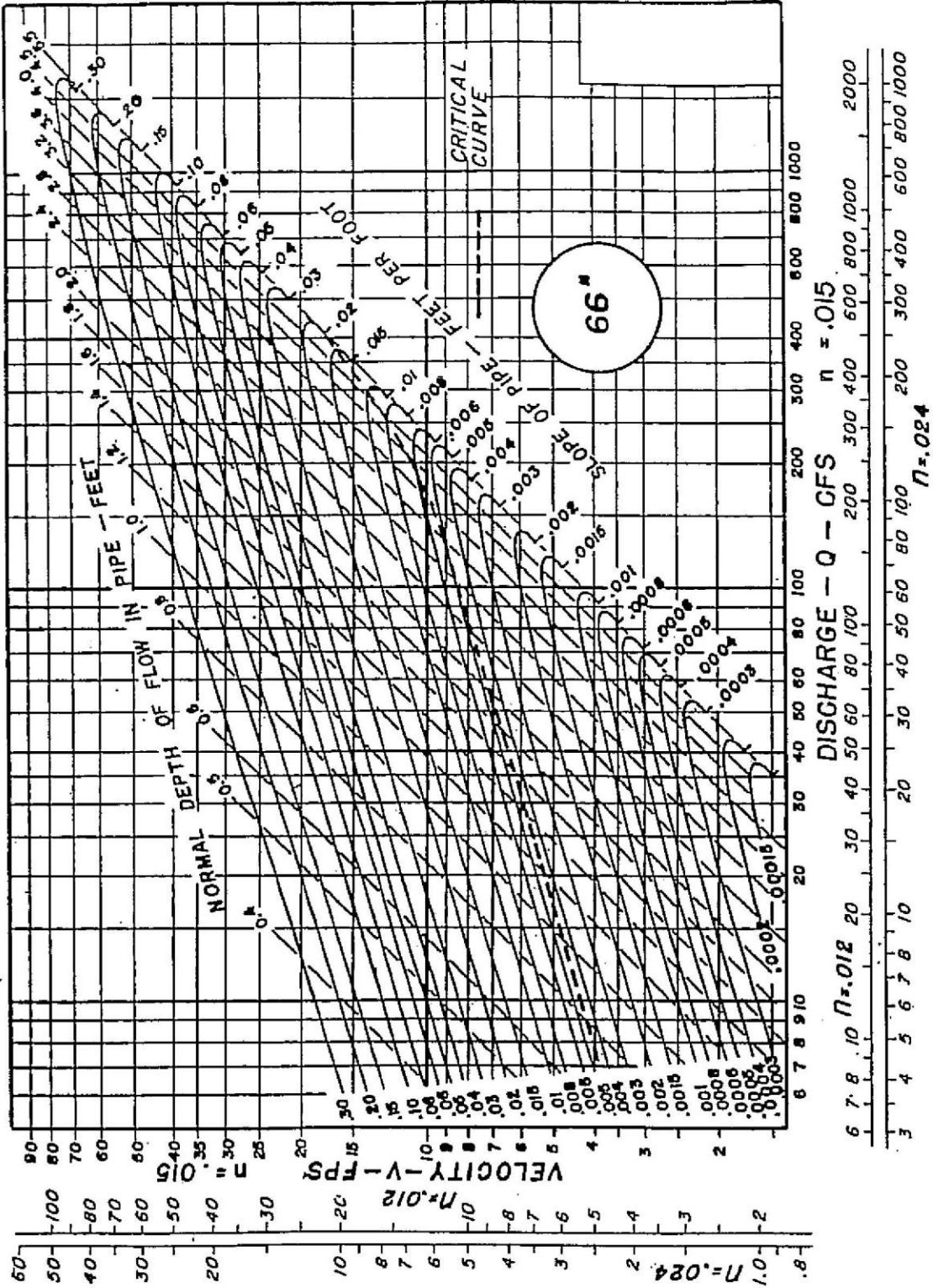

PIPE FLOW CHART
66 INCH DIAMETER

Figure 3.24

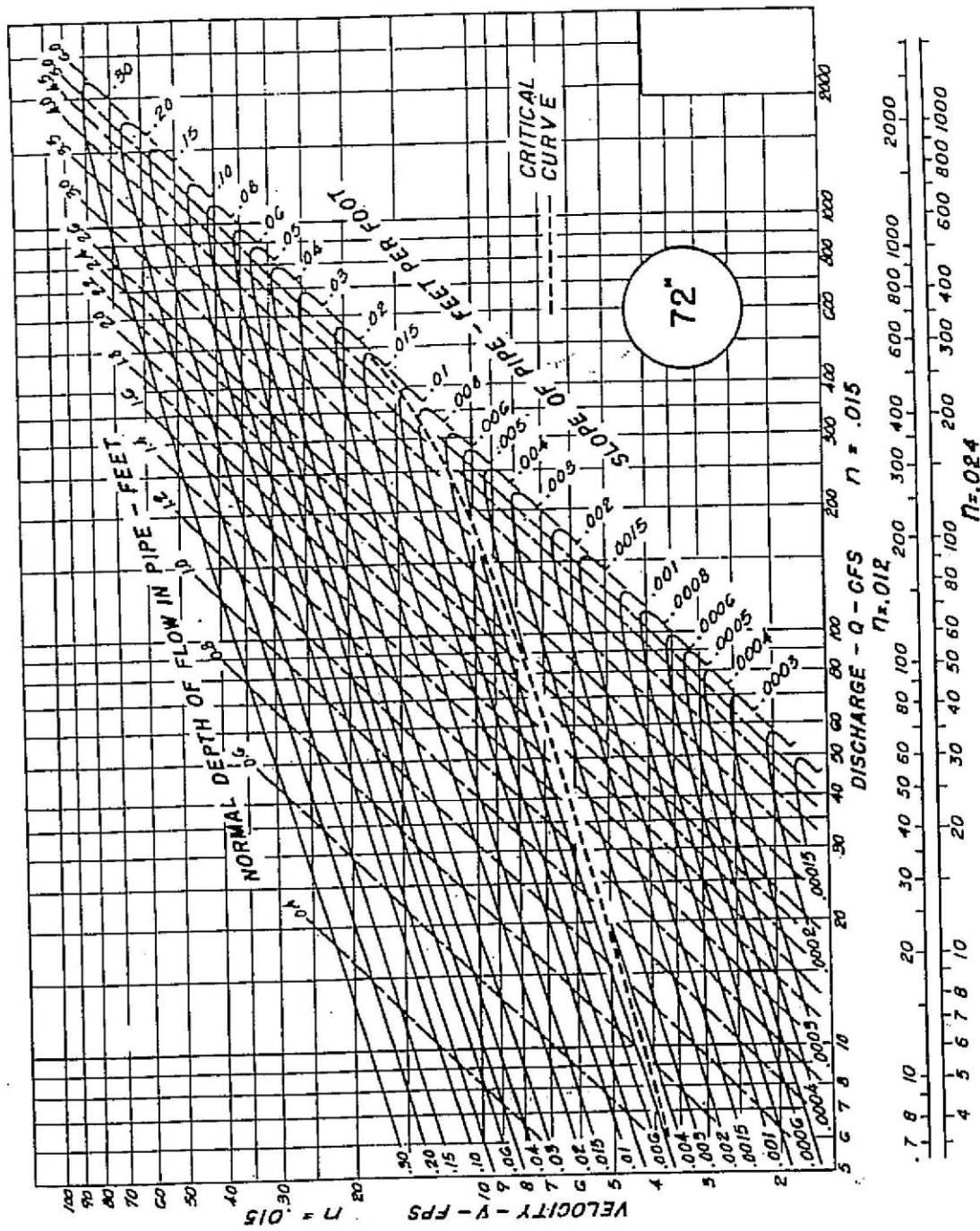

PIPE FLOW CHART
72 INCH DIAMETER

Figure 3.25

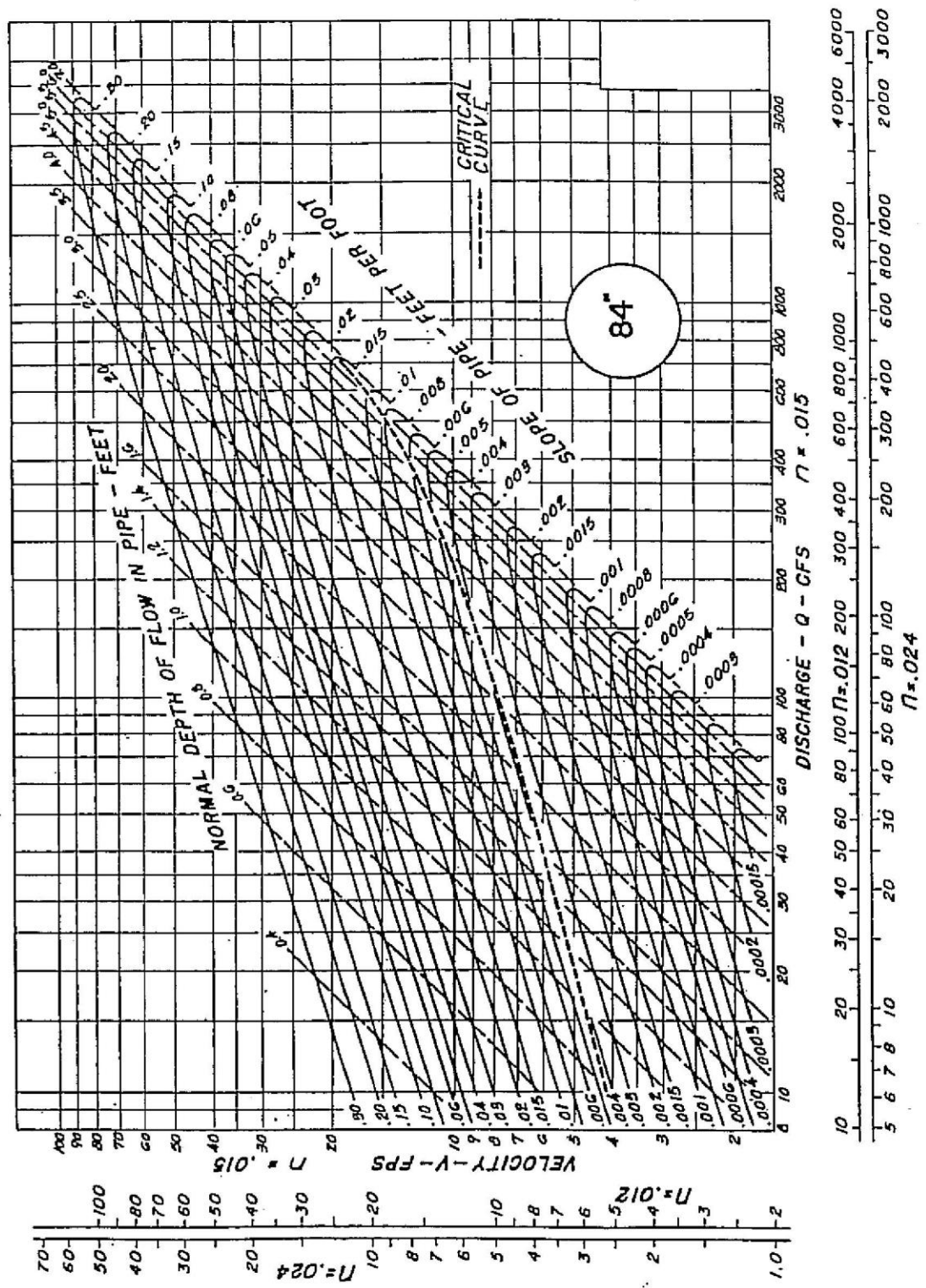

PIPE FLOW CHART
 84 INCH DIAMETER

Figure 3.26

Hydraulic Properties of Circular Conduits Flowing Partly Full

d = Depth of flow
 d_c = Critical depth
 d_m = Mean depth
 D = Diameter of pipe
 A = Area of flow
 R = Hydraulic radius
 T = Top width of flow

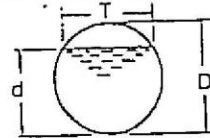

$\frac{d}{D}$ or $\frac{d_c}{D}$	$\frac{A}{D^2}$	$\frac{R}{D}$	$\frac{T}{D}$	$\frac{d_m}{D}$
1.00	0.7854	0.2500	—	—
0.95	0.7707	0.2865	0.4359	1.7681
0.90	0.7445	0.2980	0.6000	1.2408
0.85	0.7115	0.3033	0.7142	0.9962
0.80	0.6736	0.3042	0.8000	0.8420
0.75	0.6319	0.3017	0.8660	0.7297
0.70	0.5872	0.2962	0.9165	0.6407
0.65	0.5404	0.2882	0.9539	0.5665
0.60	0.4920	0.2776	0.9798	0.5021
0.55	0.4426	0.2649	0.9950	0.4448
0.50	0.3927	0.2500	1.0000	0.3927
0.45	0.3428	0.2331	0.9950	0.3445
0.40	0.2934	0.2142	0.9798	0.2994
0.35	0.2450	0.1935	0.9539	0.2568
0.30	0.1982	0.1709	0.9165	0.2163
0.25	0.1535	0.1466	0.8660	0.1773
0.20	0.1118	0.1206	0.8000	0.1397
0.15	0.0739	0.0929	0.7142	0.1035

Hydraulic Properties of Pipe Arch Conduits Flowing Partly Full

d = Depth of flow
 d_c = Critical depth
 d_m = Mean depth
 D = Diameter of pipe
 A = Area of flow
 R = Hydraulic radius
 T = Top width of flow

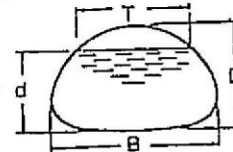

$\frac{d}{D}$ or $\frac{d_c}{D}$	$\frac{A}{BD}$	$\frac{R}{D}$	$\frac{T}{D}$	$\frac{d_m}{D}$
1.00	0.7879	0.2991	—	—
0.95	0.7762	0.3408	0.3489	2.225
0.90	0.7552	0.3549	0.4855	1.555
0.85	0.7283	0.3622	0.5848	1.245
0.80	0.6970	0.3649	0.6637	1.0503
0.75	0.6621	0.3639	0.7288	0.9085
0.70	0.6243	0.3595	0.7837	0.7966
0.65	0.5839	0.3520	0.8303	0.7033
0.60	0.5414	0.3415	0.8700	0.6223
0.55	0.4970	0.3282	0.9037	0.5500
0.50	0.4511	0.3120	0.9320	0.4840
0.45	0.4039	0.2928	0.9555	0.4227
0.40	0.3556	0.2705	0.9755	0.3616
0.35	0.3065	0.2451	0.9889	0.3100
0.30	0.2568	0.2162	0.9967	0.2577
0.25	0.2069	0.1839	0.9967	0.2076
0.20	0.1574	0.1484	0.9815	0.1603
0.15	0.10908	0.11022	0.9477	0.11505

SOURCE:
 City of
SPRINGDALE
 Arkansas

Hydraulic Properties of Circular Conduits
 Flowing Partly Full
 Hydraulic Properties of Pipe Arch Conduits
 Flowing Partly Full

Figure 13.27

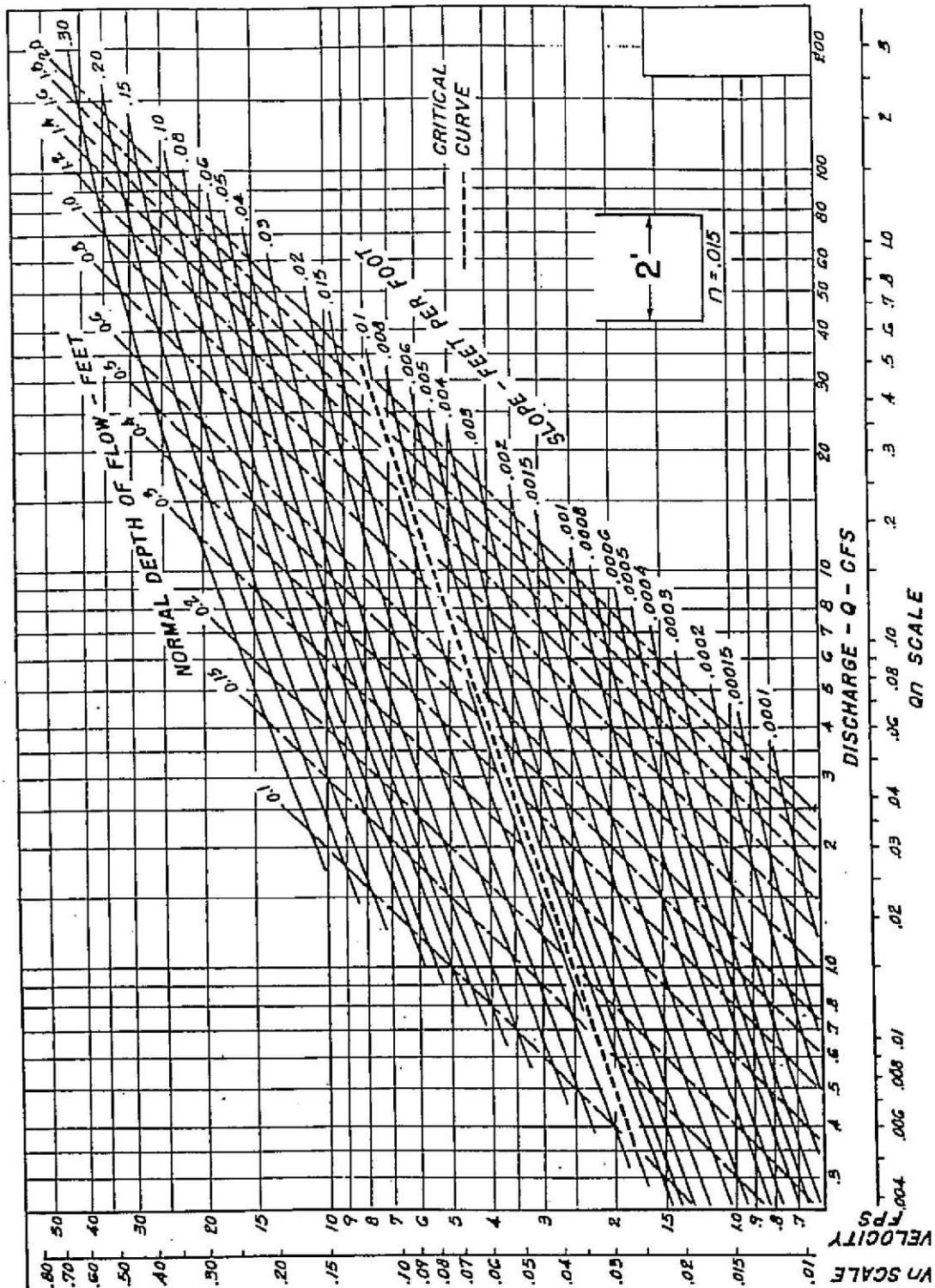

Source: Figures 3.28 to 3.41
 U.S. Department of Transportation
 Federal Highway Administration
 Design Charts for Open Channel Flow

CHANNEL CHART
 VERTICAL $b = 2$ Ft.

Figure 3.28

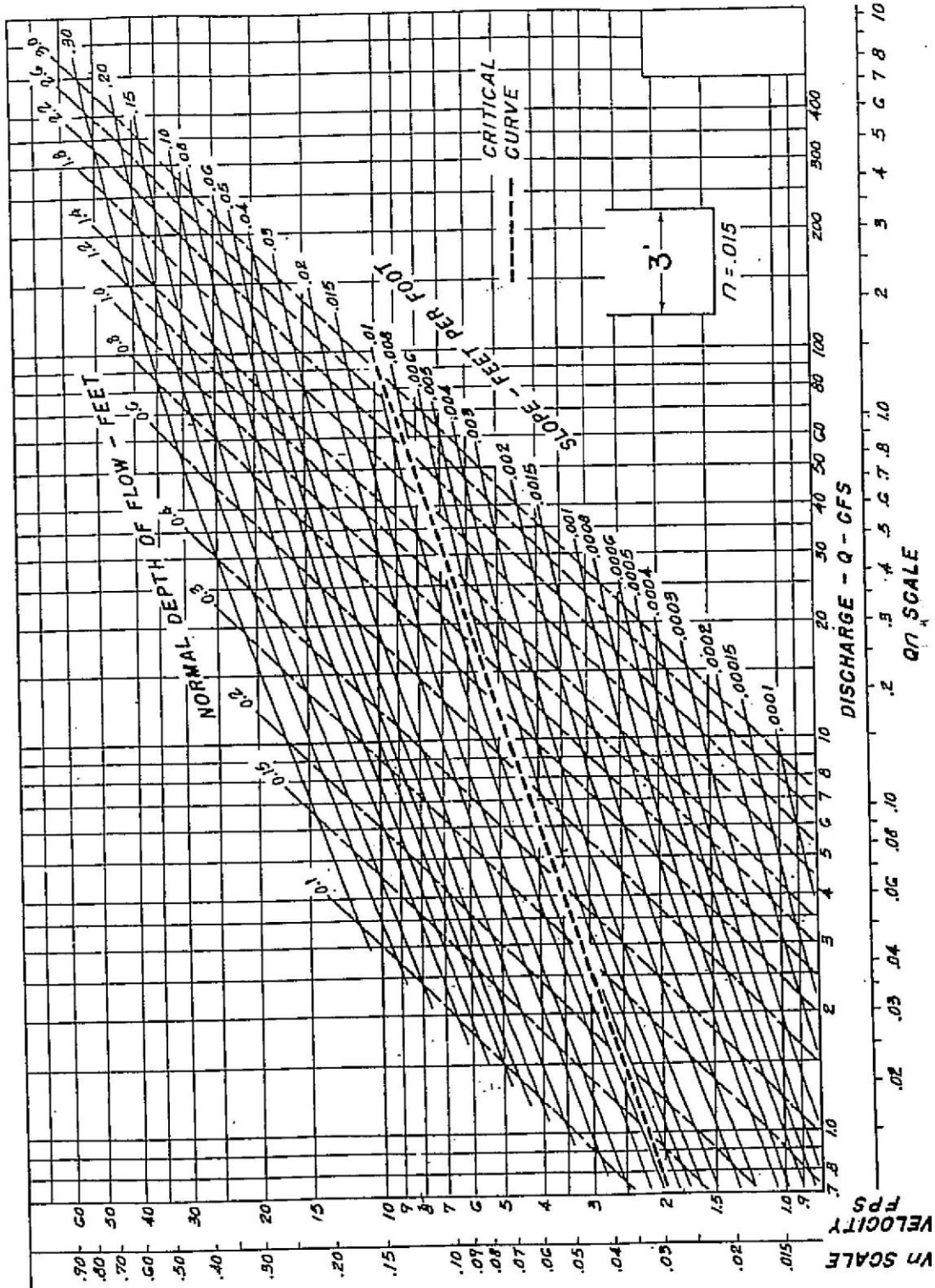

CHANNEL CHART
VERTICAL $b = 3$ Ft.

Figure 3.29

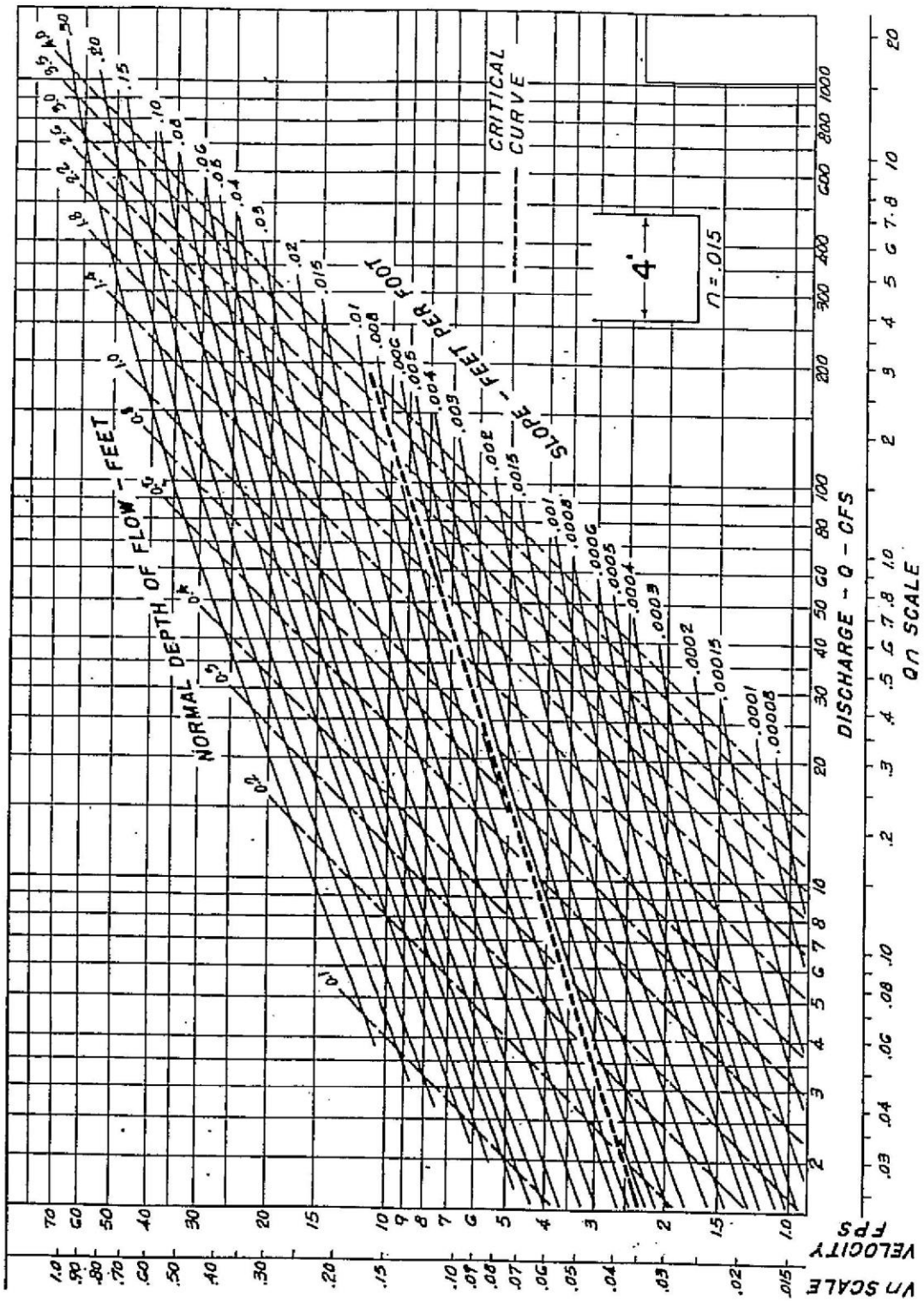

CHANNEL CHART
VERTICAL $b = 4$ Ft.

Figure 3.30

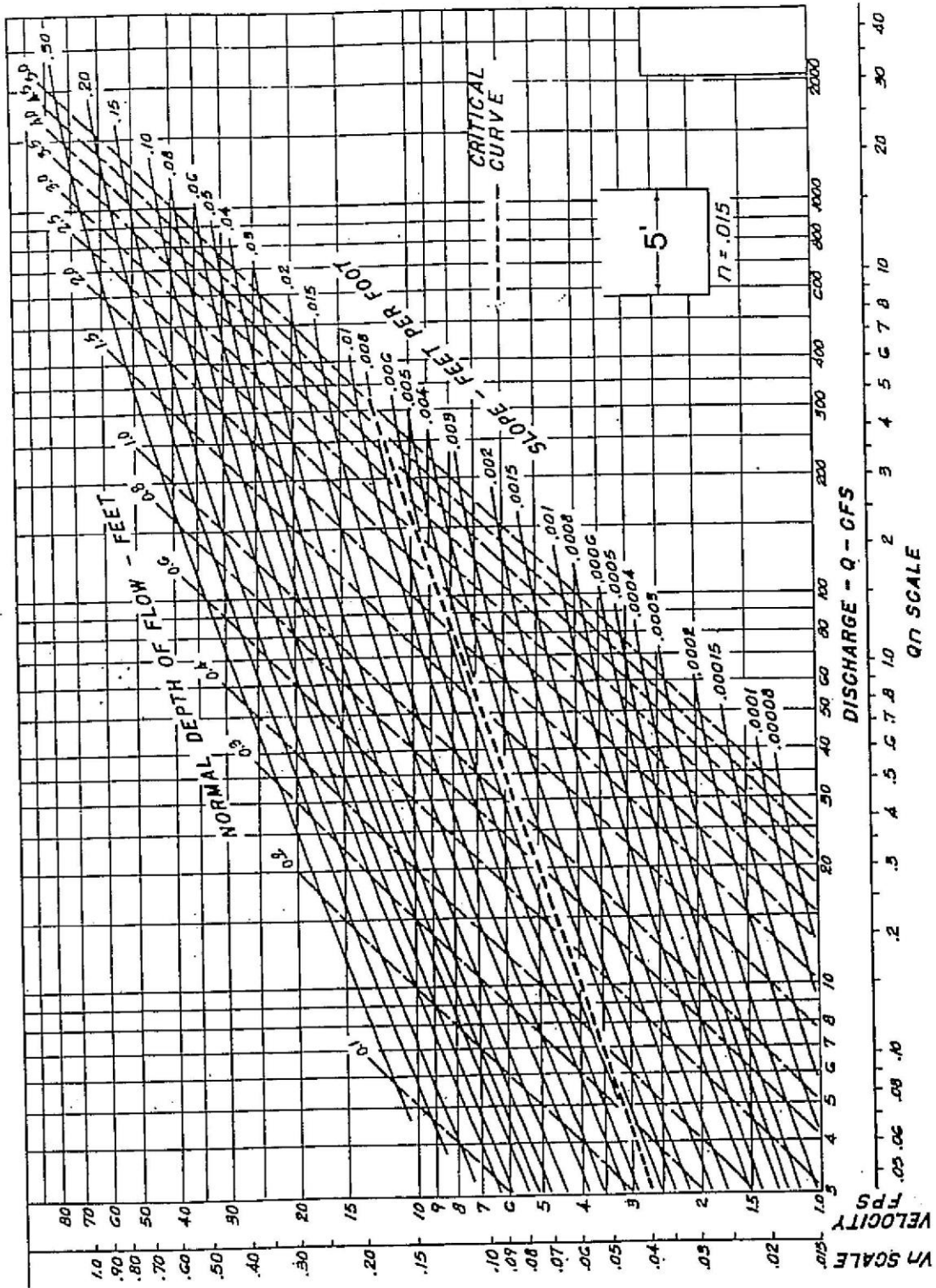

CHANNEL CHART
VERTICAL $b = 5$ Ft.

Figure 3.31

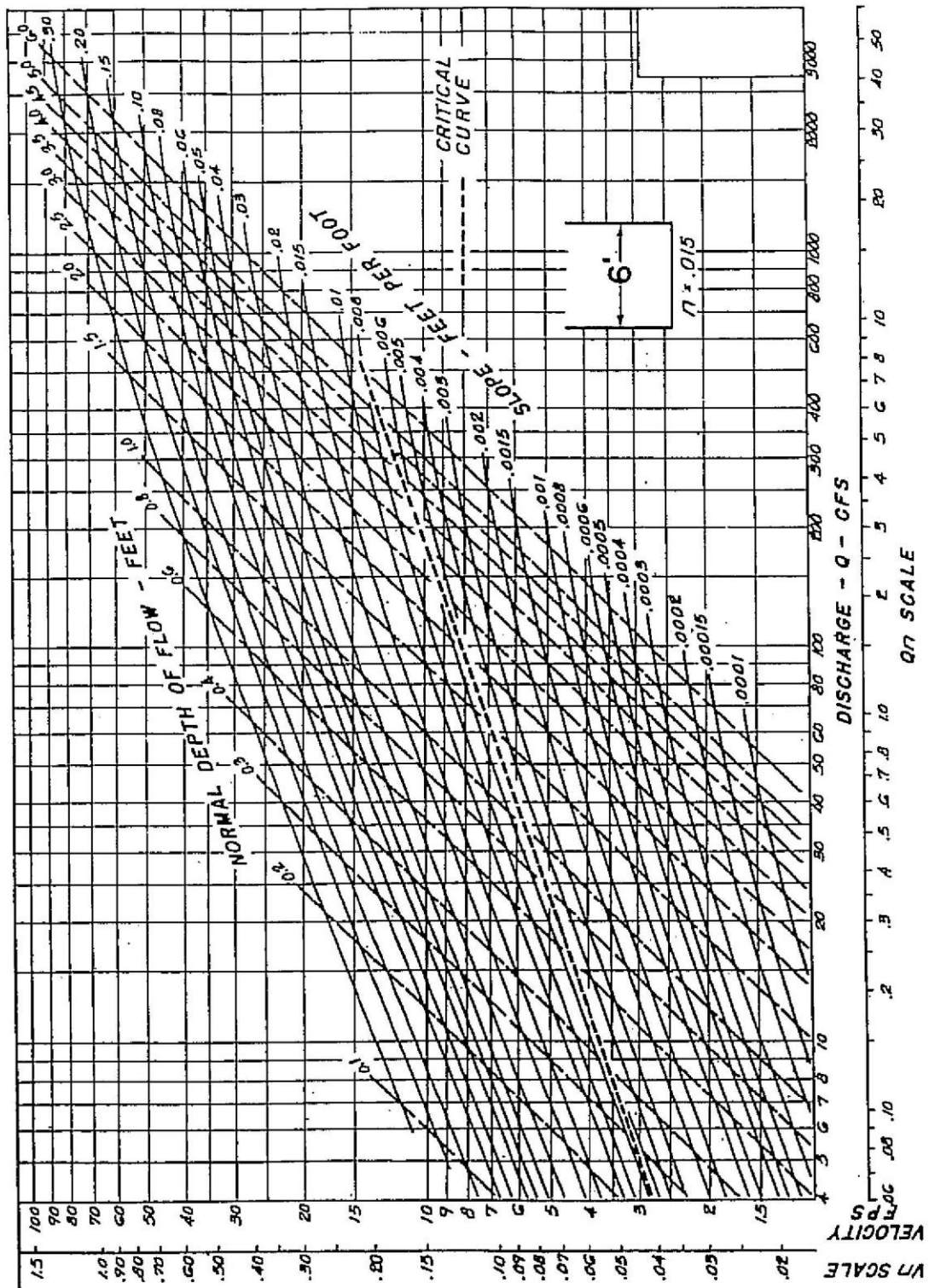

CHANNEL CHART
VERTICAL $b = 6$ Ft.

Figure 3.32

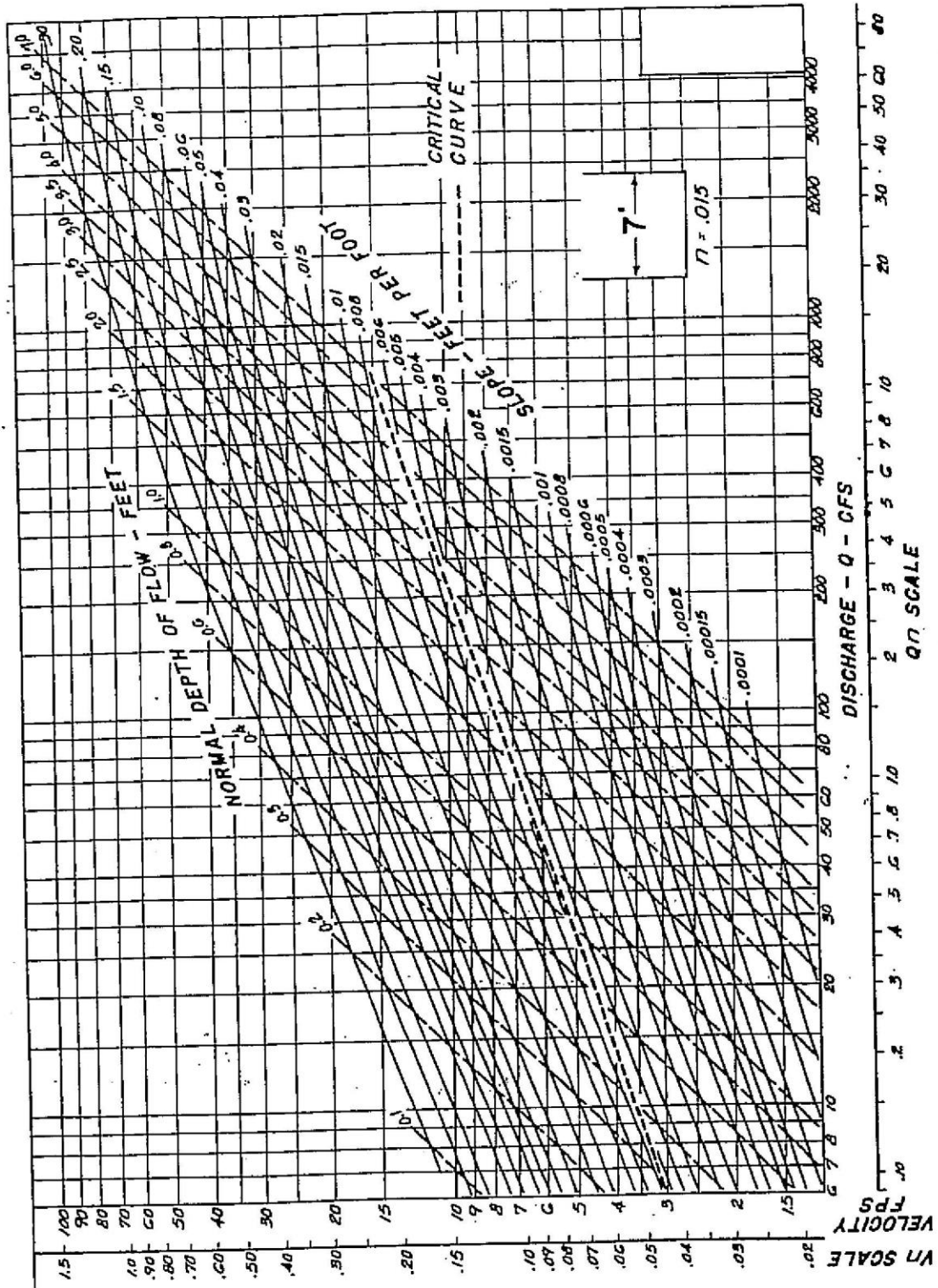

CHANNEL CHART
 VERTICAL $b = 7$ Ft.

Figure 3.33

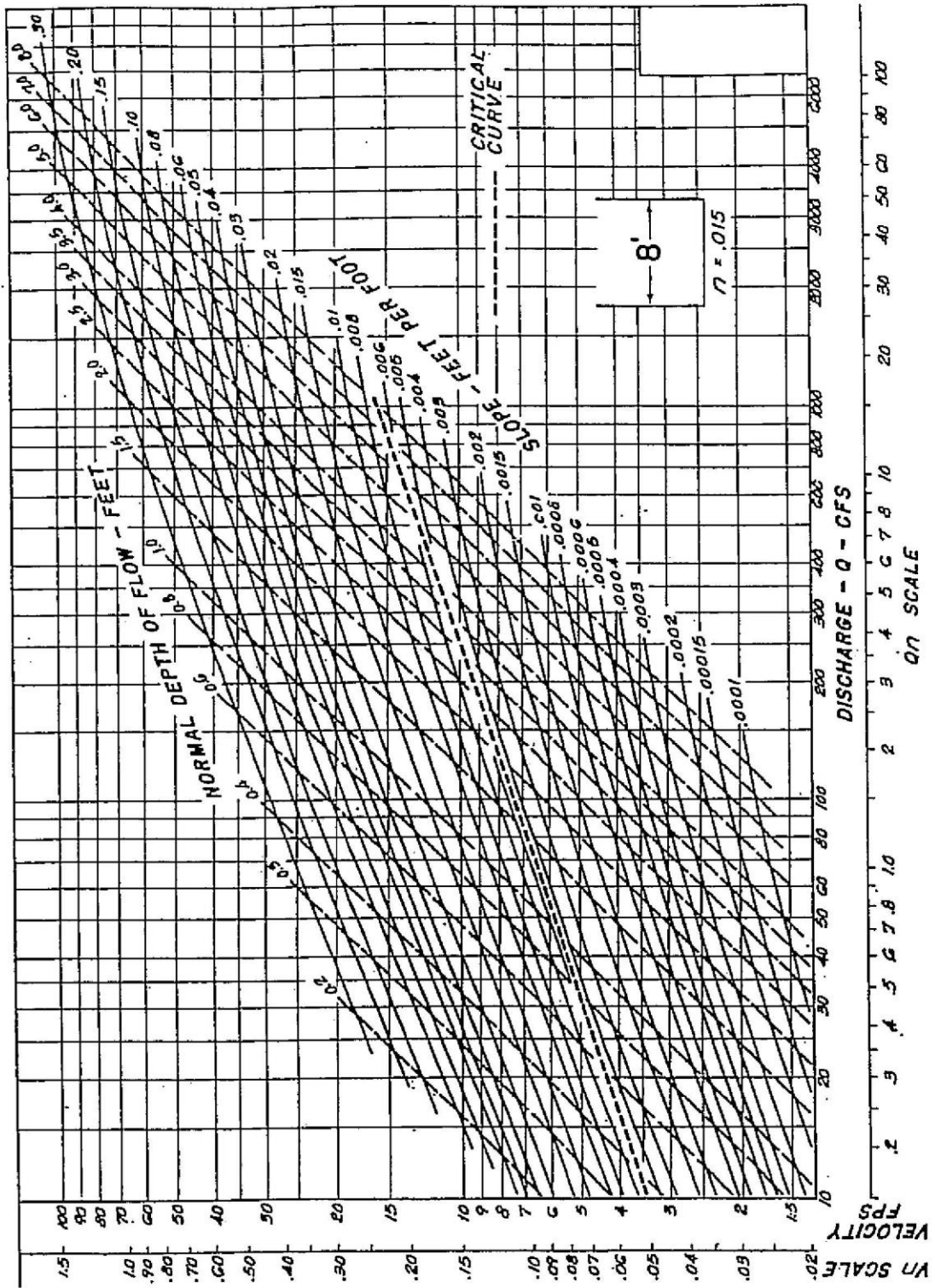

CHANNEL CHART
VERTICAL $b = 8$ Ft.

Figure 3.34

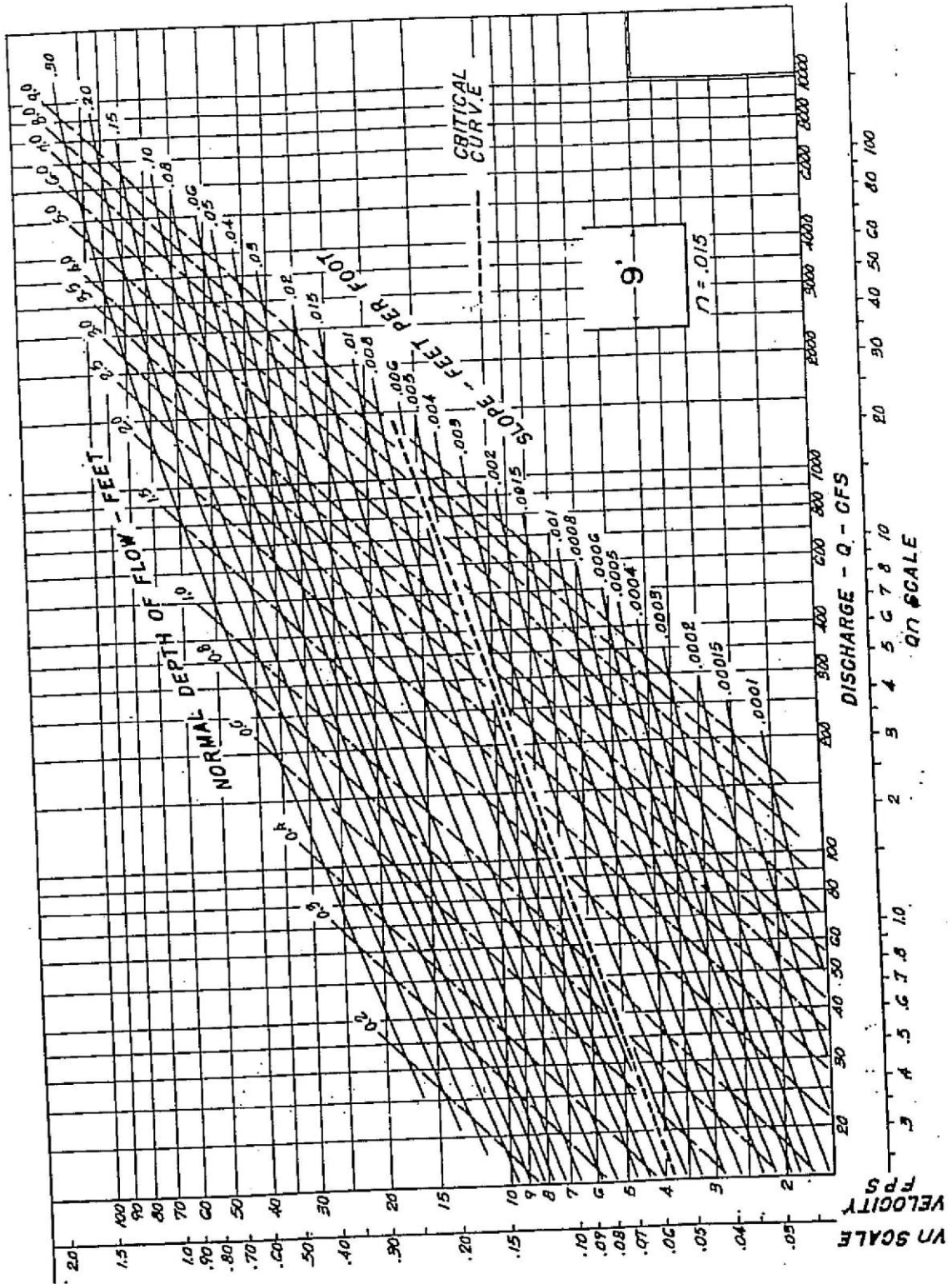

CHANNEL CHART
VERTICAL $b = 9$ Ft.

Figure 3.35

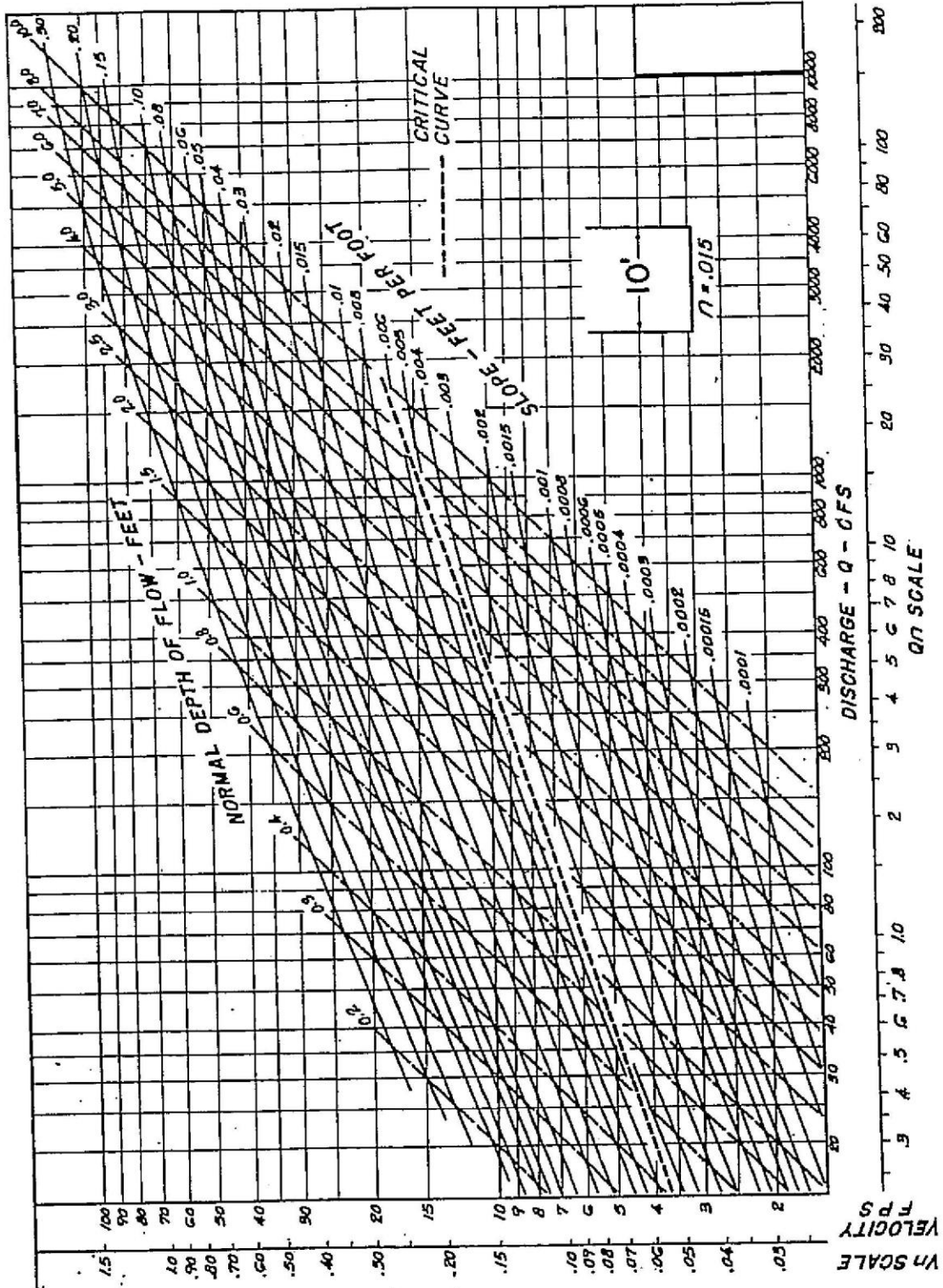

CHANNEL CHART
VERTICAL $b = 10$ Ft.

Figure 3.36

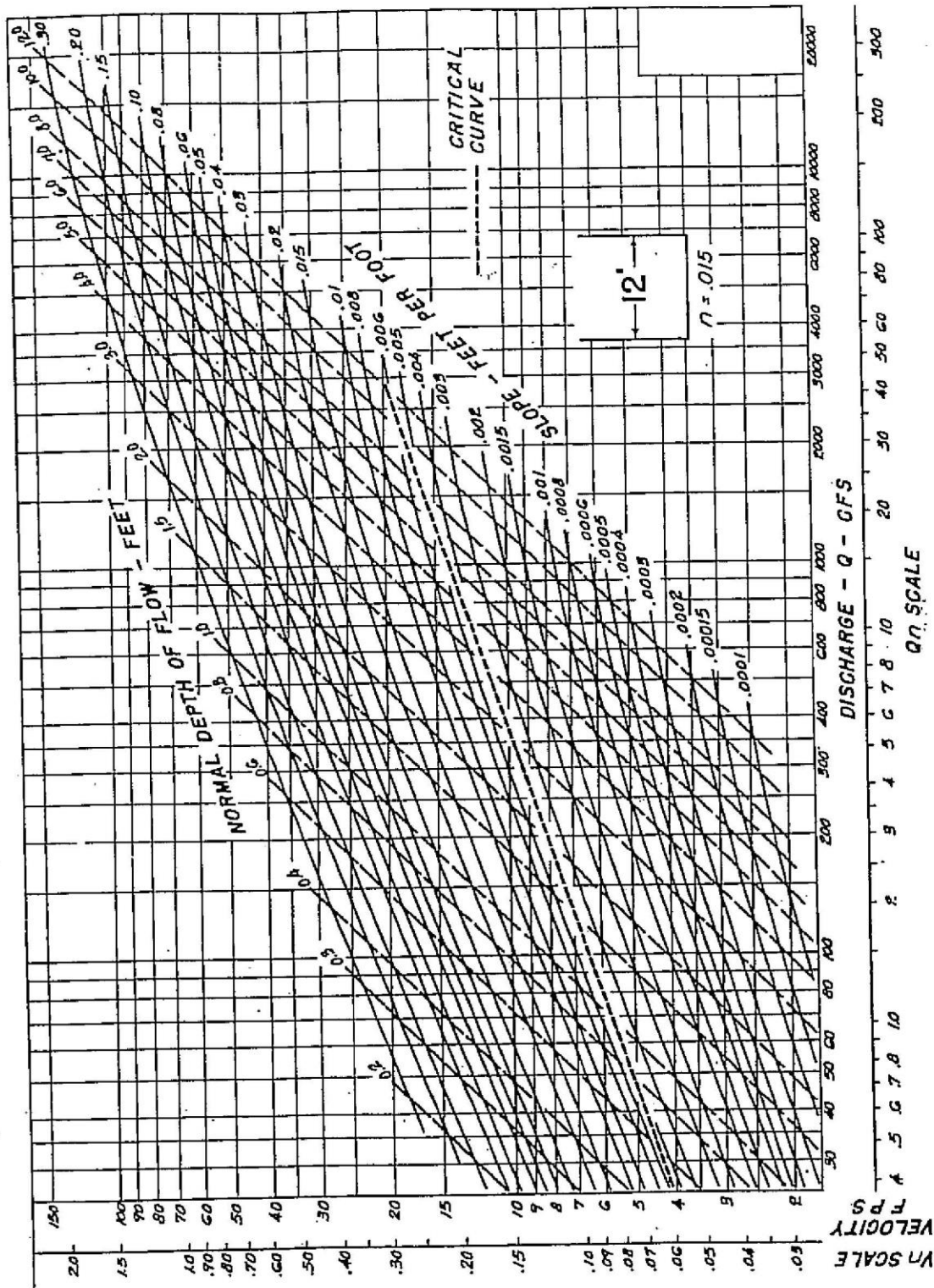

CHANNEL CHART
VERTICAL $b = 12$ Ft.

Figure 3.37

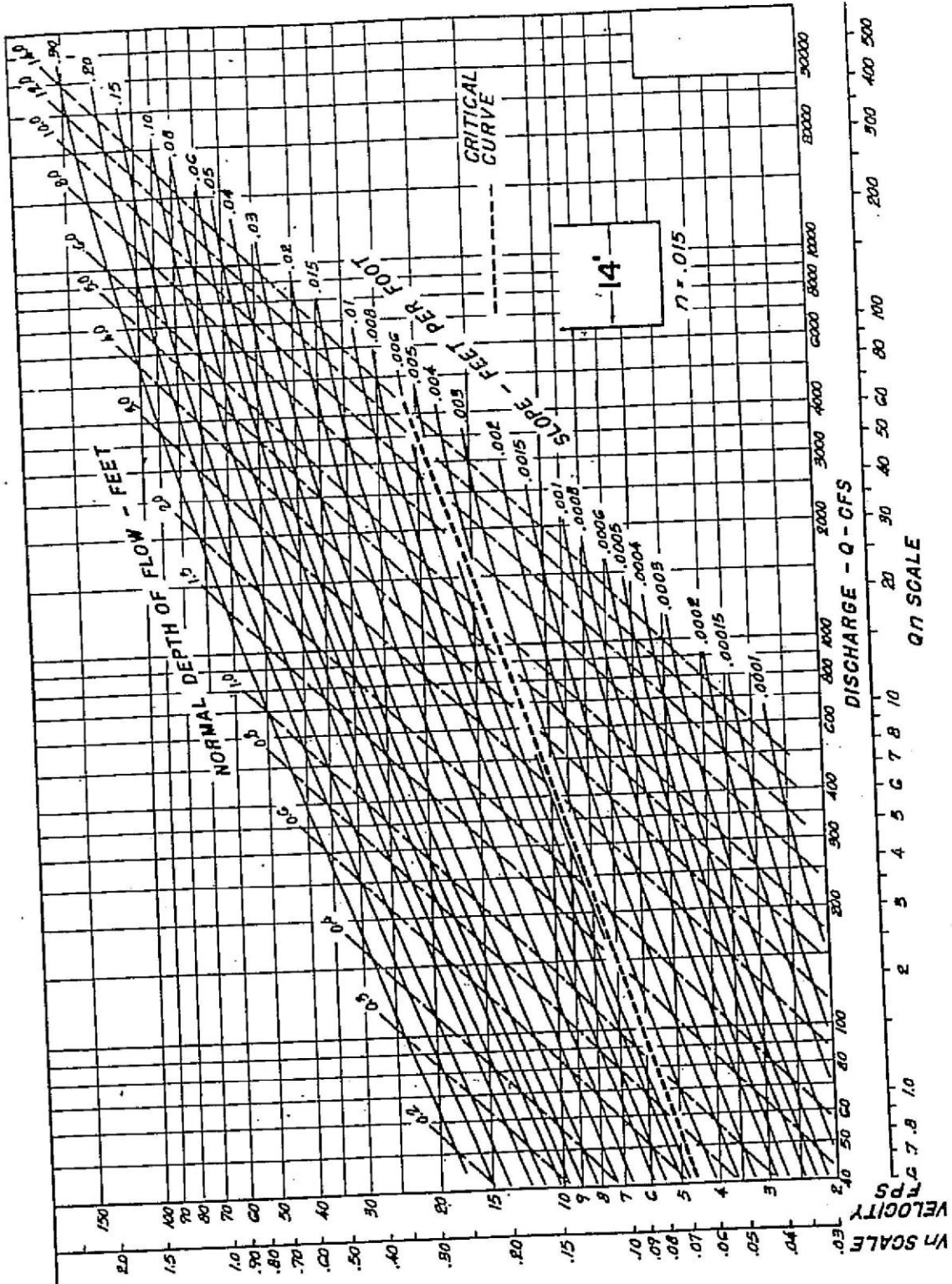

CHANNEL CHART
VERTICAL $b = 14$ Ft.

Figure 3.38

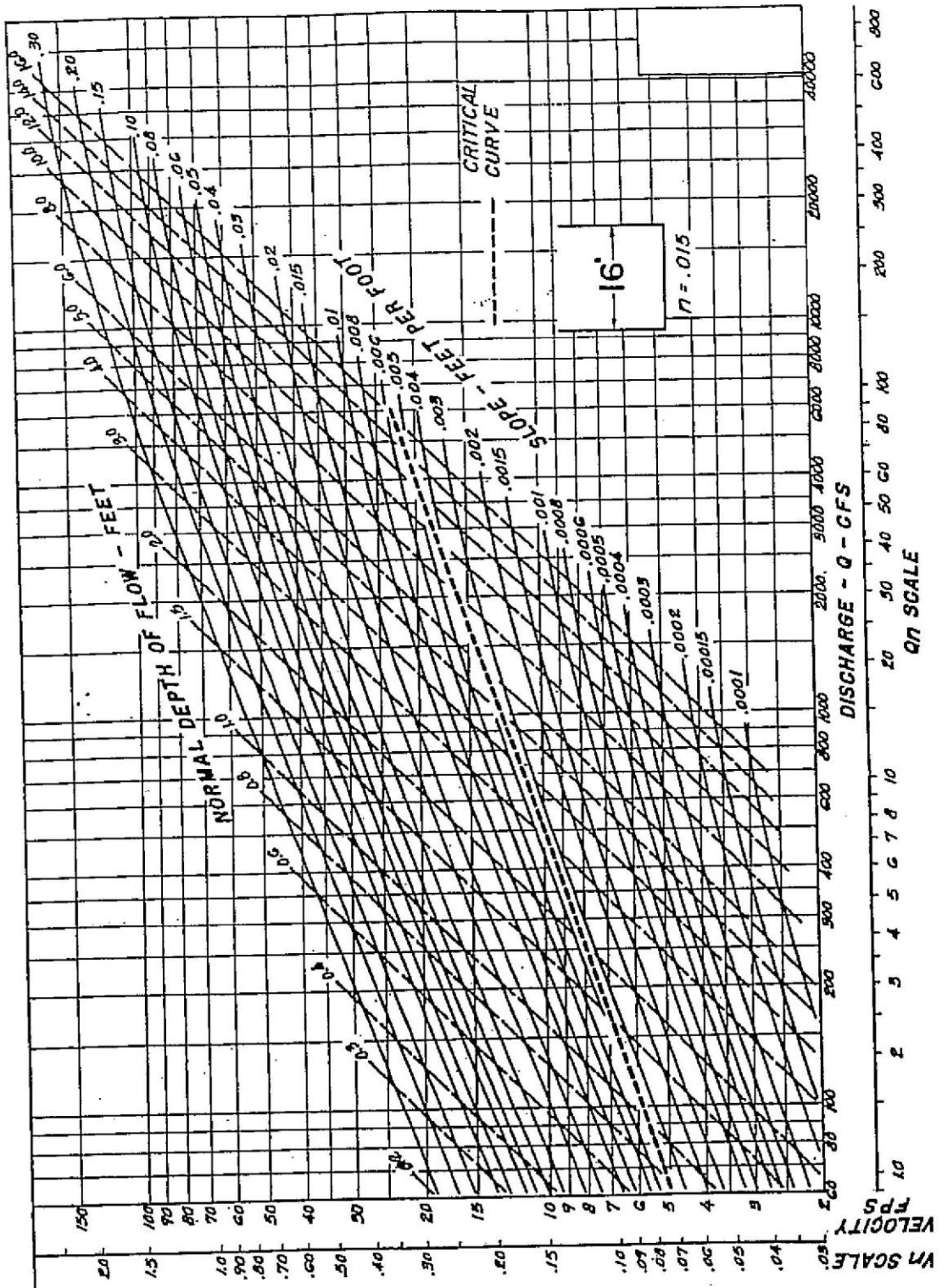

CHANNEL CHART
VERTICAL $b = 16$ Ft.

Figure 3.39

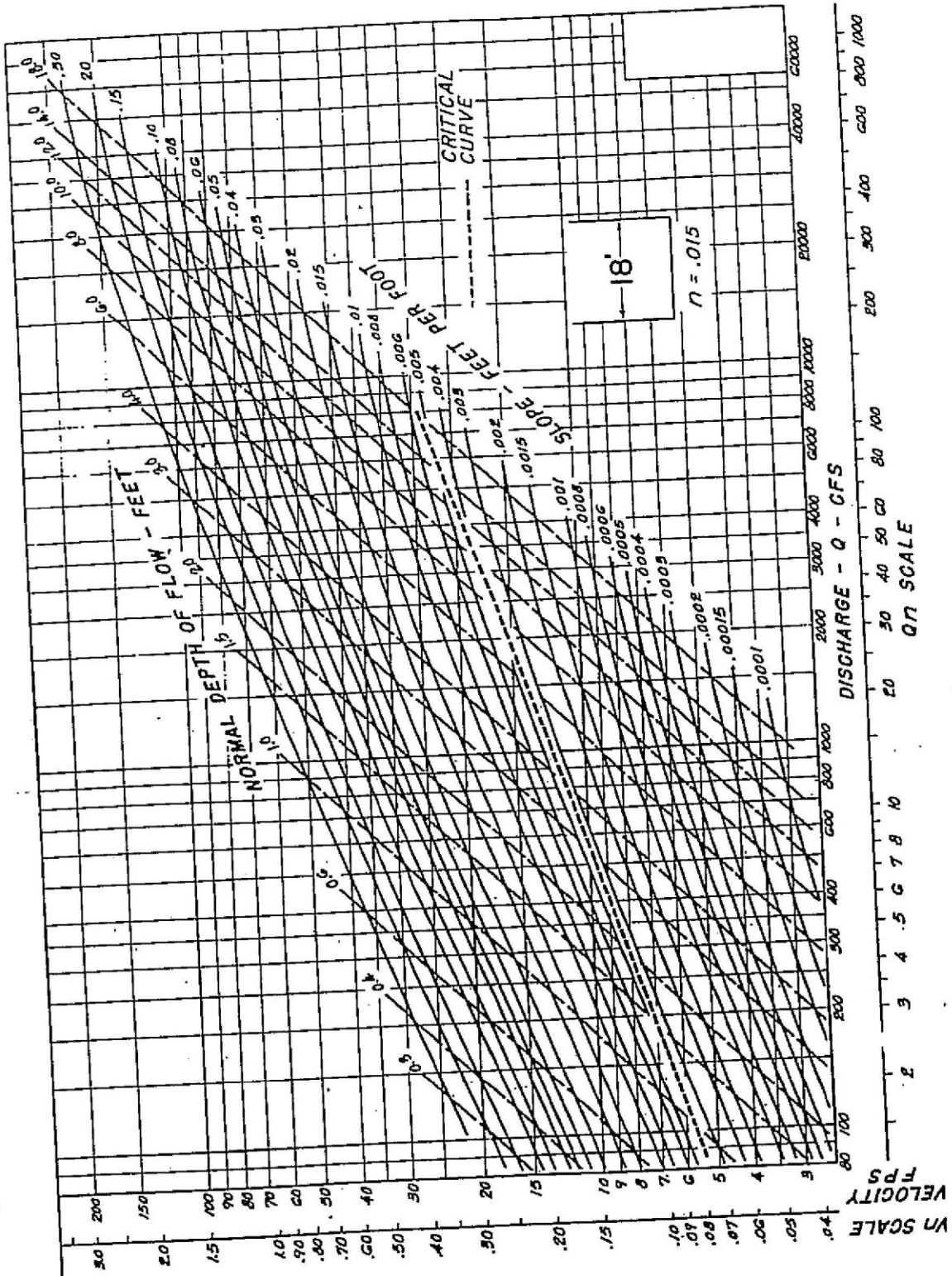

CHANNEL CHART
VERTICAL $b = 18$ Ft.

Figure 3.40

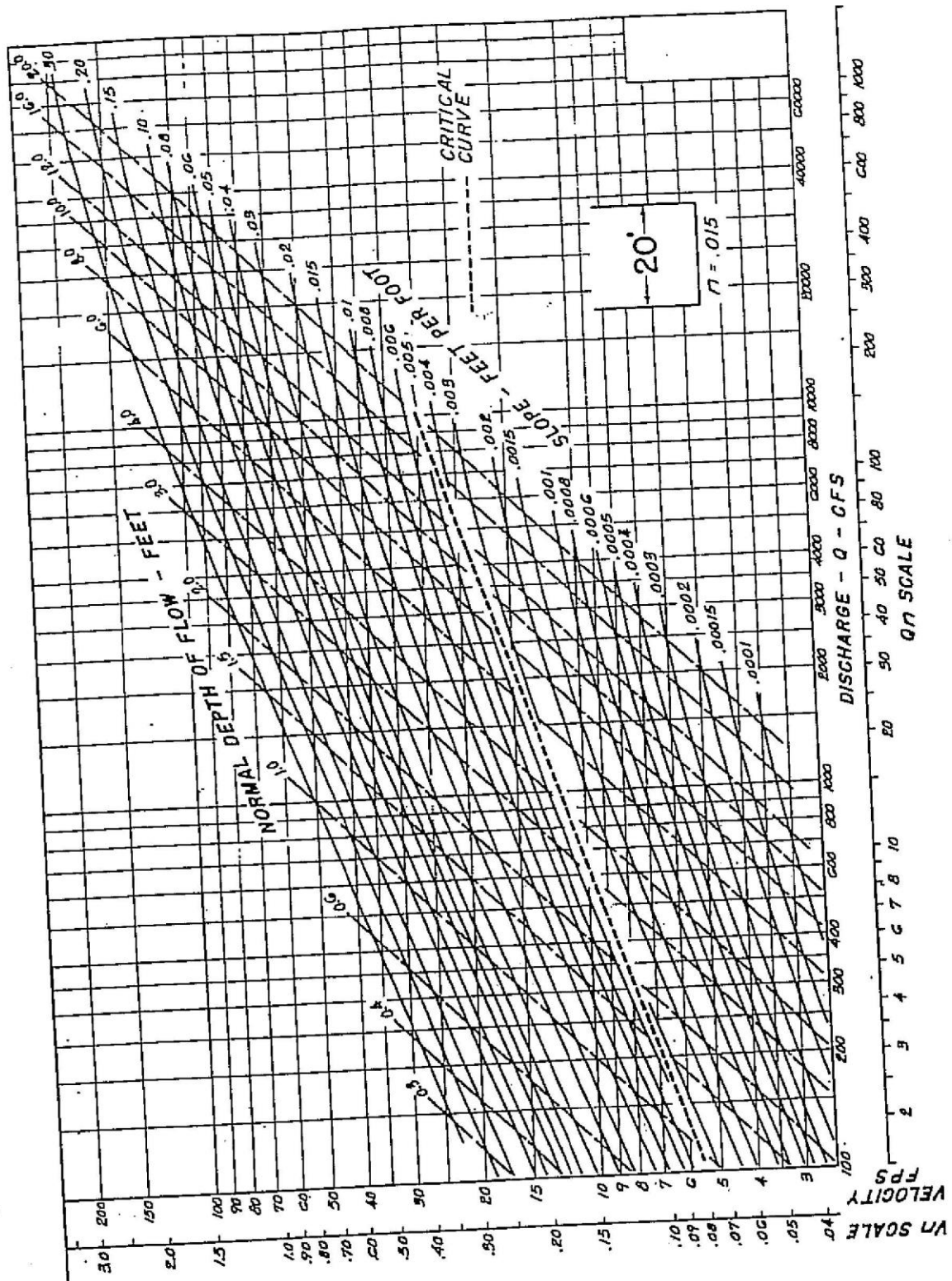

CHANNEL CHART
VERTICAL $b = 20$ Ft.

Figure 3.4

TABLE OF CONTENTS - SECTION 4

SECTION 4 - CULVERT HYDRAULICS

- 4.1 General
- 4.2 Inlet Control
- 4.3 Outlet Control
- 4.4 Headwalls and End walls
 - 4.4.1 General
 - 4.4.2 Conditions at Entrance
 - 4.4.3 Selection of Headwall or End wall
- 4.5 Culvert Discharge Velocities
 - 4.5.1 Energy Dissipators
 - 4.5.1.1 Short Stilling Basin (USBR Type III)
 - 4.5.1.2 Baffled Apron Stilling Basin (USBR Type IX)
 - 4.5.1.3 Impact Stilling Basin (USBR Type VI)
 - 4.5.1.4 Short Stilling Basin (SAF Type)
- 4.6 Culvert Types and Sizes
- 4.7 Fill Heights and Bedding
- 4.8 Types of Culvert Flow
- 4.9 Culvert Design Procedure
- 4.10 Culvert Analysis Software
 - 4.10.1 FHWA Culvert Analysis (HY8)

SECTION IV - CULVERT HYDRAULICS

4.1 GENERAL

The function of a drainage culvert is to pass the design storm flow under a roadway or railroad without causing excessive backwater and without creating excessive downstream velocities. The designer shall keep energy losses and discharge velocities within reasonable limits when selecting a structure.

Culvert flow may be separated into two major types of flow, inlet or outlet control. Under inlet control, the cross sectional area of the barrel, the shape of the inlet, and the amount of ponding (headwater) at the inlet are primary design considerations. Outlet control is dependent upon the depth of water in the outlet channel (tailwater), the slope of the barrel, type of culvert material, and length of the barrel.

4.2 INLET CONTROL

The size of a culvert operating with inlet control is determined by the size and shape of the inlet and the depth of ponding allowable (headwater) between the flowline elevation of a culvert and the elevation of a finished grade surface or surrounding buildings and facilities. See Figure 4.1. Factors not affecting inlet control design are the barrel roughness, slope, and length and depth of the tailwater.

The headwater (HW) depth for a culvert of a given diameter or height (D) where a discharge is given can be determined by obtaining the HW/D value from Hydraulic Engineering Circular #5, FWHA. Maximum headwater depth shall be 1 foot lower than the top of road/curb or as approved in writing by the City Staff. The elevation of adjacent facilities (i.e., buildings, etc.) must be reviewed for flooding.

4.3 OUTLET CONTROL

A culvert will operate under outlet control when the depth of the tailwater, the length, the slope, or roughness of the culvert barrel act as the control on the quantity of water able to pass through a given culvert. See Figure 4.1. Energy head required for a culvert to operate under outlet control consists of velocity head (H_v), entrance loss (H_e), and friction loss (H_f). This energy head (H) is obtained from Hydraulic Engineering Circular #5, FWHA, and entrance loss coefficients from Table 4.1. The headwater depth (HW) at the culvert entrance is calculated by means of the following formula:

$$HW_o = H + h_o - LS_o \quad (4.1)$$

Where: H = Energy head

 L = Length of culvert (ft.)

S_o = Slope of barrel (feet per foot)

h_o = $\frac{d_c + D}{2}$ or TW, whichever is greater

d_c = Critical depth of flow in the barrel. Critical depth may be determined by using Hydraulic Engineering Circular #5, FWHA.

D = Height of pipe or box

TW = Tailwater depth

The maximum desirable headwater depth for culverts operating under outlet control shall be the same as described in Section 4.3.

See Section 4.8 for detailed types of culvert flow and Section 4.9 for examples of culvert sizing computations.

4.4 HEADWALLS AND END WALLS

4.4.1 GENERAL

The normal functions of properly designed headwalls and end walls are to anchor the culvert, to prevent movement due to the lateral pressures, to control erosion and scour resulting from excessive velocities and turbulence, and to prevent adjacent soil from sloughing into the waterway opening. Headwalls shall be constructed of reinforced concrete and may either be straight parallel headwalls, flared headwalls, or warped headwalls with or without aprons, as may be required by site conditions. Multi-barrel culvert crossings of roadways at an angle of 15° or greater shall be accompanied by adequate inlet and outlet control sections.

4.4.2 CONDITIONS AT ENTRANCE

It is important to recognize that the operational characteristics of a culvert may be completely changed by the shape or condition at the inlet or entrance. Design of culverts involves consideration of energy losses that occur at the entrance. The entrance head losses may be determined by the following equation:

$$h_e = K_e \frac{(V_2^2 - V_1^2)}{2g} \quad (4.2)$$

h_e = Entrance head loss (feet)

V_2 = Velocity of flow in culvert

V_1 = Velocity of approach (fps)

K_e = Entrance loss coefficient as shown in Table 4.1.

4.4.3 SELECTION OF HEADWALL OR ENDWALL

In general, the following guidelines should be used in the selection of the type of headwalls or end walls:

No Headwall or End wall:

- Approach velocities are low (below 6 fps).
- Backwater pools may be permitted.
- Approach channel is undefined.
- Ample right-of-way or easement is available.
- Downstream channel protection is not required.

Parallel Headwall and End wall:

- Approach velocities are low [below six (6) feet per second].
- Backwater pools are permitted.

Flared Headwall and End wall:

- Channel is well defined.
- Approach velocities are between 6 and 10 fps.
- Medium amounts of debris exist

The wings of flared walls should be located with respect to the direction of the approaching flow instead of the culvert axis.

Warped Headwall and End wall:

- Channel is well defined and concrete lined.
- Approach velocities are between 8 and 20 fps.
- Medium amounts of debris exist.

These headwalls are effective with drop down aprons to accelerate flow through the culvert and are effective for transitioning flow from closed conduit flow to open channel flow. This type of headwall should be used only where the drainage structure is large and right-of-way or easement is limited.

4.5 CULVERT DISCHARGE VELOCITIES

The velocity of discharge from culverts should be limited as shown in Table 4.2. Consideration must be given to the effect of high velocities, eddies, or other turbulence on the natural channel, downstream property, and roadway embankment.

Energy dissipators will be required at channel drops when the unit discharge exceeds 35 cfs and at culvert outlets when the discharge velocity exceeds those recommended in Table 4.2 for a given downstream channel condition.

4.5.1 Energy Dissipators

Energy dissipators are used to dissipate excessive kinetic energy in flowing water that could promote erosion. An effective energy dissipator must be able to retard the flow of fast moving water without damage to the structure or to the channel below the structure.

Impact-type energy dissipators direct the water into an obstruction that diverts the flow in many directions and in this manner dissipates the energy in the flow. Baffled outlets and baffled aprons are two impact-type energy dissipators.

Other energy dissipators use the hydraulic jump to dissipate energy. In this type of structure, water flowing at a higher than critical velocity is forced into a hydraulic jump, and energy is dissipated in the resulting turbulence. Stilling basins are an example of this type of dissipator, where energy is diffused as flow plunges into a pool of water.

Generally, the impact-type of energy dissipator is considered to be more efficient than the hydraulic jump-type. Also the impact-type energy dissipator results in smaller and more economical structures.

The design of energy dissipators is based on the empirical data resulting from a comprehensive series of model structure studies by the U.S. Bureau of Reclamation, as detailed in its book Hydraulic Design of Stilling Basins and Energy Dissipators. Four impact-type energy dissipators are briefly explained here and illustrated on Figures 4.2 through 4.6.

4.5.1.1 SHORT STILLING BASIN (USBR TYPE III)

The most effective way to shorten a stilling basin is to modify the jump by the addition of appurtenances in the basin. However, the appurtenances should be self-cleaning or non-clogging. The recommended design for Type III stilling basin is shown in Figure 4.2. The chute blocks at the upstream end of a basin tend to corrugate the jet, lifting a portion of it from the floor to create a greater number of energy dissipating eddies. These eddies result in a shorter length of jump than would be possible without them and tend to stabilize the jump. The baffle piers act as an impact dissipation device, and the end sill is for scour control. The end sill has little or no effect on the jump. The only purpose of the end sill in a stilling basin is to direct the remaining bottom currents upward and away from the channel bed.

This type of basin is recommended at the outlet of a sloping channel drop when there is adequate tailwater. For insufficient tailwater, USBR Type IX basin is recommended.

4.5.1.2 BAFFLED APRON STILLING BASIN (USBR TYPE IX)

Baffled aprons are used to dissipate the energy in the flow at a drop. They require no initial tailwater to be effective, although channel bed scour is not as deep and is less extensive when the tailwater forms a pool into which the flow discharges. The chutes are constructed on an excavated slope, 2:1 or flatter, extending to below the channel bottom. Backfill is placed over one or more rows of baffles to restore the original streambed elevation. When scour or downstream channel degradation occurs, successive rows of baffle piers are exposed to prevent excessive acceleration of the flow entering the channel. If degradation does not occur, the scour creates a stilling pool at the downstream end of the chute, stabilizing the scour pattern. The simplified hydraulic design of the baffled apron is shown on Figure 4.3.

This type of basin is recommended for a channel drop where insufficient tailwater prevents the use of a Type III stilling basin. The basin can also be used for channel drops when adequate tailwater is available.

4.5.1.3 IMPACT STILLING BASIN (USBR TYPE VI)

This stilling basin is an impact-type energy dissipator, contained in a relatively small box-like structure, and requiring little or no tailwater for successful performance. The general arrangement of the basin for various discharges is shown on Figure 4.4. This type of basin is subjected to large dynamic forces and turbulence that must be considered in the structural design. The structure should be made sufficiently stable to resist sliding against the impact load on the baffle wall and must resist the severe vibrations. Riprap should also be provided along the bottom and sides adjacent to the structure to avoid the tendency for scour of the outlet channel downstream from the end sill when shallow tailwater exists. This type of stilling basin is very effective at the outlet of storm drains or culverts where there is little or no tailwater.

4.5.1.4 SHORT STILLING BASIN (SAF TYPE)

The St. Anthony Falls or SAF stilling basin is a generalized design that uses a hydraulic jump to dissipate energy, as illustrated on Figure 4.6. The design is based on model studies conducted by the Soil Conservation Service at the

St. Anthony Falls Hydraulic Laboratory of the University of Minnesota.

The SAF basin is similar to the USBR Type III basin in that chute blocks, baffle blocks, and an end sill are used to reduce the basin size. It is recommended for use at small structures where $F_r=1.7$ to 17, as measured at the dissipator entrance. The reduction in basin length achieved through the use of appurtenances is about 80 percent of the free hydraulic jump length.

The comparison between the USBR Type III basin and the SAF basin shows that under certain conditions, the SAF basin may be more economical or fit the terrain better. The designer is encouraged to check both designs before selecting one. The design procedure is described in "Hydraulic Design of Energy Dissipators for Culverts and Channels," HEC-14, USDOT, FHWA, December, 1975.

4.6 CULVERT TYPES AND SIZES

The only permissible types of culverts under all public roadways and streets are reinforced concrete box, round, or elliptical concrete pipe or pipe arch.

The minimum size of pipe for all culverts shall be 18" or the equivalent sized elliptical pipe or arch pipe. Box culverts may be constructed in sizes equal to or larger than 4' x 3' (width versus height). Box culverts smaller than 4' x 3' in any dimension must be approved by the City prior to construction.

Reinforced concrete pipe is to be used under roadways, unless approved in advance by the City. Such approval shall be considered on a case by case basis.

Flared, precast concrete and metal pipe aprons may be used in lieu of headwalls to improve the hydraulic capabilities of the culverts. The material of the flared end section shall match the pipe material.

4.7 FILL HEIGHTS AND BEDDING

The minimum cover over any reinforced concrete culvert or box culvert shall be 12" to the top of the subgrade. All other types of culverts shall have a minimum cover of 24" to the top of the subgrade. Minimum cover less than these values shall be fully justified in writing and approved by the City Staff prior to proceeding with final plans. Maximum fill heights shall be according to manufacture's specifications. Box culverts shall be structurally designed to accommodate earth and live load to be imposed upon the culvert. Refer to the Arkansas Highway and Transportation Departments Standard Drawings –

R.C. Box Culverts – “X” Series. When installed within public right-of-ways or easements, all culverts shall be capable of withstanding minimum HS20 loading.

Where culverts under railroad facilities are necessary, the designer shall obtain permits from the affected railroad.

4.8 TYPES OF CULVERT FLOW

Type I	Flowing Part Full with Outlet Control and Tailwater Depth Below Critical Depth. (Figure 4.7)
Type II	Flowing Part Full with Outlet Control and Tailwater Depth Above Critical Depth. (Figure 4.8)
Type III	Flowing Part Full with Inlet Control. (Figure 4.9)
Type IVA	Flowing Full with Submerged Outlet. (Figure 4.10)
Type IVB	Flowing Full with Partially Submerged Outlet. (Figure 4.11)

4.9 CULVERT DESIGN PROCEDURE

STEP 1 - SELECTING CULVERT SIZE:

The computations involved in selecting the smallest feasible barrel that can be used without exceeding the design headwater elevation are summarized in the tabulation sheet titled "Culvert Computations," Table 4.3.

INITIAL DATA:

Enter initial data and complete required information for first approximation. The square feet of opening for the initial trial size may be estimated by the ratio of design discharge divided by 10.

TAILWATER:

The tailwater depth is influenced by conditions downstream of the culvert outlet. If the culvert outlet is located near the inlet of a downstream culvert, then the headwater elevation of the downstream culvert may define the tailwater depth for the upstream culvert. If the culvert outlet is operating in a free outfall condition (e.g., waterfall), then the tailwater is taken as 0.0.

If the culvert discharges into an open channel, then tailwater conditions should be determined by either backwater conditions, normal depth (sub-critical flow), or critical depth (supercritical flow). Figures 4.12, 4.13, and 9.1 provide a graphic solution for normal depth flow that may be calculated by Manning's Equation:

$$Q = \frac{1.486 AR^{2/3} S^{1/2}}{n}$$

In any case, the tailwater depth is defined as the depth of water measured from the flow line of the culvert (invert) at the outlet, to the water surface elevation at the outlet.

Enter tailwater depth in Column 8 and applicable stream data in upper left-hand portion of Culvert Computation Form.

STEP 2 - PERFORM OUTLET CONTROL CALCULATIONS:

These calculations are performed before inlet control calculations in order to select the smallest feasible barrel that can be used without the required headwater elevation in outlet control exceeding the allowable headwater elevation.

Figures 4.14 through 4.20 illustrate nomograph solutions for outlet control of various types and materials of storm sewer culverts.

- Column 1: Enter the span times height dimensions (or diameter of pipe) of culvert.
- Column 2: Enter the type of structure and design of entrance.
- Column 3: Enter the design discharge or quotient of design discharge divided by the applicable denominator.
- Column 4: Enter the Entrance Loss Coefficient from Table 4.1.
- Column 5: Enter the head from the applicable outlet control nomograph; in the example problem use Figure 4.16.
- Column 6: Enter the critical depth from appropriate nomograph; in the example problem use Figure 4.27. Critical depth cannot exceed height of culvert opening.

Column 7: For tailwater elevations less than the top of the culvert at the outlet, hydraulic grade line is found by solving for h_o using the following equation:

$$h_o = \frac{d_c + D}{2}$$

where: h_o = Vertical distance in feet from culvert invert at outlet to the hydraulic grade line in feet

d_c = Critical depth in feet

D = Height of culvert opening in feet

Column 8: Enter the tailwater elevation from initial data shown at top of form. Refer to tailwater comments under STEP 1 for additional guidelines.

Column 9: Enter the product of culvert length times the slope.

Column 10: Headwater elevation required for culvert to pass flow in outlet control (HW_o) is computed by the following equation:

$$HW_o = H + h_o - LS$$

Note: Use TW elevation in lieu of h_o where $TW > h_o$

Additional trials may be required. Space for additional trials is provided on Culvert Computations Form.

STEP 3 - PERFORM INLET CONTROL CALCULATIONS FOR CONVENTIONAL AND BEVELED EDGE CULVERT:

After minimum barrel size has been determined under STEP 2, the next procedure is similar to that used in FHWA's Hydraulic Engineering Circular Number 5, "Hydraulic Charts for the Selection of Highway Culverts."

Figures 4.21 through 4.26 illustrate nomograph solutions for inlet control conditions of various types and materials of storm sewer culverts.

The computations involved in computing inlet headwater elevation are summarized in the tabulation sheet used in STEP 2, titled "Culvert Computations," Table 4.4.

Column 11: Enter ratio of headwater to height of structure from Figure 4.22.

Column 12: HW is derived by multiplying Column 11 by the height (or diameter) of culvert.

Column 13: Enter greater of two headwaters (Column 10 or 12).

Column 14: Inlet control governs, outlet velocity equals Q/A , where A is defined by the cross-sectional area of normal depth of flow in the culvert barrel at "S". Figures 4.12, 4.13, 3.7, and 3.14 to 3.26, 3.4, 3.28 to 3.41, Sections III and IV, provide a graphic solution for estimating normal depth of flow and velocity. Manning's Equation may also be used:

$$V = \frac{1.486 R^{2/3} S^{1/2}}{n}$$

If outlet control governs, outlet velocity equals Q/A , where A is the cross-sectional area of flow in the culvert barrel at the outlet.

Column 15: Figures shown in this column are believed to be self-explanatory.

IMPROVED INLETS:

See Arkansas Highway and Transportation Department's Manual for improved inlet or side tapered inlet design and broken back culvert design.

4.10 FHWA CULVERT ANALYSIS SOFTWARE

Computerized analysis by experienced engineers is encouraged. In addition to the analysis previously described, the City will allow the analysis of trapezoidal and circular channels, and pipe and box culvert analysis using the FHWA Culvert Analysis (HY8) or similar approved software.

4.10.1 FHWA CULVERT ANALYSIS (HY8)

FHWA Culvert Analysis (HY8) software was developed by Pennsylvania State University in cooperation with the Bridge Division (HNG-31). The HY8 software is sponsored by the Rural Technical Assistance Program (RTAP) of the National Highway Institute under Project 18B administered by the Pennsylvania Department of Transportation.

The HY8 software automates the design methods described in HDS5, Hydraulic Design of Highway Culverts, FHWA-IP-85-15. HDS5 is available from the Government Printing Office, Washington, DC 20402. The HY8 computer program may be downloaded directly from the Federal

Highway Administration. Refer to the FHWA software page at <http://www.fhwa.dot.gov/engineering/hydraulics/software/softwaredetail.cfm>.

HYDRAULIC DATA FOR CULVERTS
(D) CULVERT ENTRANCE LOSSES

STRUCTURE AND ENTRANCE TYPE	COEFFICIENT k
Pipe, Concrete	
Projecting from fill, socket end (groove-end)	0.2
Projecting from fill, square cut end	0.5
Headwall or headwall and wingwalls	
Socket end of pipe (groove-end)	0.2
Square-edge	0.5
Rounded (radius = 1/12D)	0.2
Metered to conform to fill slope	0.7
End-Section conforming to fill slope	0.5
Beveled edges, 33.7° or 45° bevels	0.2
Side-or slope-tapered inlet	0.2
Pipe, or Pipe-Arch, Corrugated Metal	
Projecting from fill (no headwall)	0.9
Headwall or headwall and wingwalls square-edge	0.5
Metered to conform to fill slope, paved or unpaved slope	0.7
End-Section conforming to fill slope	0.5
Beveled edges, 33.7° or 45° bevels	0.2
Side-or slope-tapered inlet	0.2
Box, Reinforced Concrete	
Headwall parallel to embankment (no wingwalls)	
Square-edged on 3 edges	0.5
Rounded on 3 edges to radius of 1/12 barrel dimension, or beveled edges on 3 sides	0.2
Wingwalls at 30° to 75° to barrel	
Square-edged at crown	0.4
Crown edge rounded to radius of 1/12 barrel dimension, or beveled top edge	0.2
Wingwall at 10° to 25° to barrel	
Square-edged at crown	0.5
Wingwalls parallel (extension of sides)	
Square-edged at crown	0.7
Side-or slope-tapered inlet	0.2

*Note: "End-section conforming to fill slope," made of either metal or concrete, are the sections commonly available from manufacturers. From limited hydraulic tests they are equivalent in operation to a headwall in both inlet and outlet control. Some end sections, incorporating a closed taper in their design have a superior hydraulic performance.

SOURCE:
City of
SPRINGDALE
Arkansas

Table 4.1

Table 4.2

Culvert Discharge-Velocity Limitations

Downstream Condition	Maximum Allowable Discharge Velocity (FPS)
Earth	6 FPS
Sodded Earth	8 FPS
Paved or Riprap Apron	15 FPS
Shale	10 FPS
Rock	15 FPS

SOURCE:
City of
SPRINGDALE
Arkansas

Table 4.2

CULVERT COMPUTATIONS
(SQUARE AND BEVELED EDGES)

DESIGNER: _____
DATE: _____

FORM HYD 4-1
PROJECT: _____

HYDROLOGIC AND CHANNEL INFORMATION

STREAM DATA

Q₁ = _____ cfs
Q₂ = _____ cfs

TW₁ = _____
TW₂ = _____

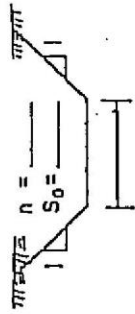

SKETCH

STATION: _____

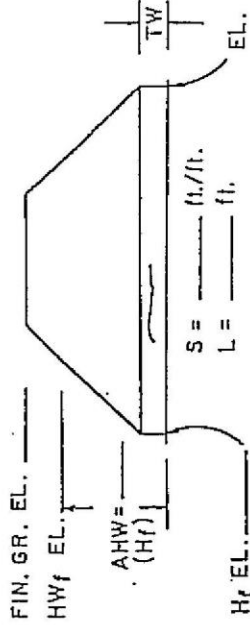

TRIAL SIZE NO.	STRUCTURE TYPE B ENTRANCE DESIGN	Q Q/NB	HEADWATER COMPUTATION										OUTLET VELOCITY ft./sec.	COST	COMMENTS			
			(a) Ke	H	dc	(b) ho	(c) TW	(d) LS	(e) HW ₀	(f) HW D	INLET CONT. HW	CONTROL LINE HW						
0	1	2	3	4	5	6	7	8	9	10	11	12	13	14	15	16		

(a) Entrance loss coefficient "dc" cannot exceed D.
 (b) $h_o = \frac{dc + D}{2}$ or TW, whichever is larger.
 (c) TW = d_n in natural channel, or other downstream control.
 (d) HW₀ = H + H₀ - LS
 (e) Use _____ for Conventional face.
 (f) Use _____ for Beveled Edge.

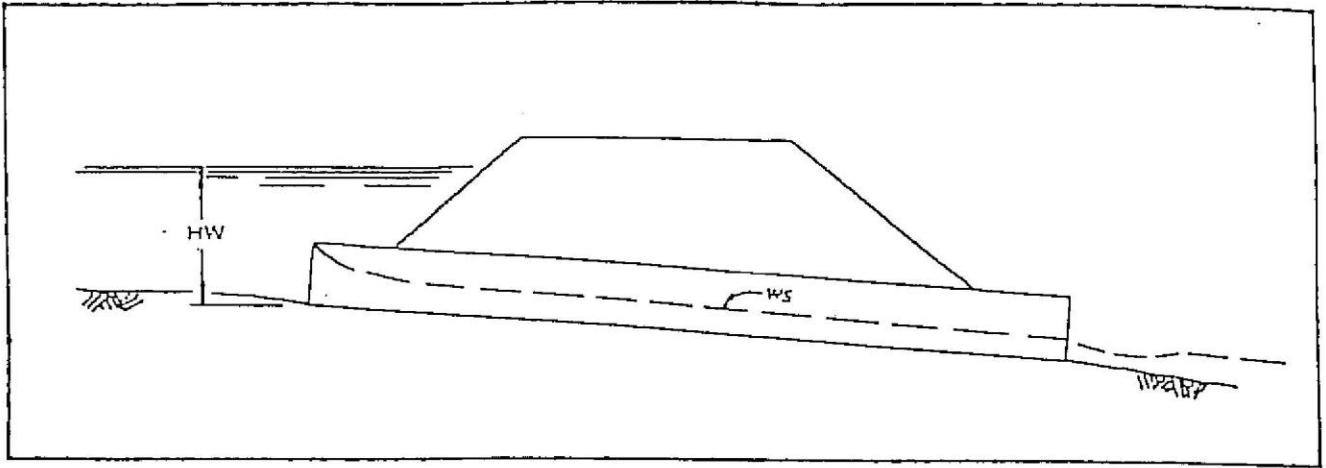

INLET CONTROL

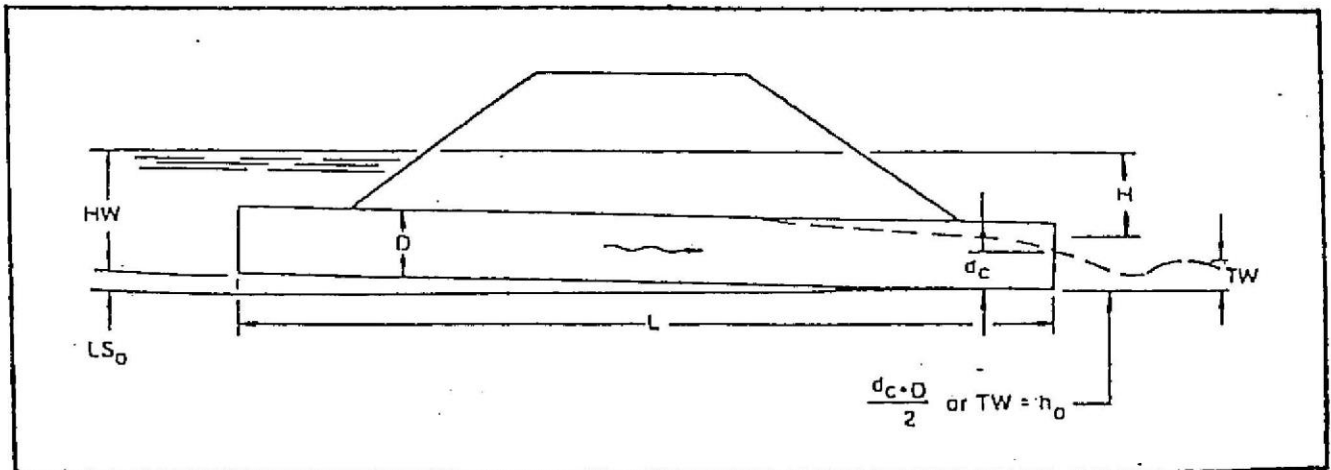

OUTLET CONTROL

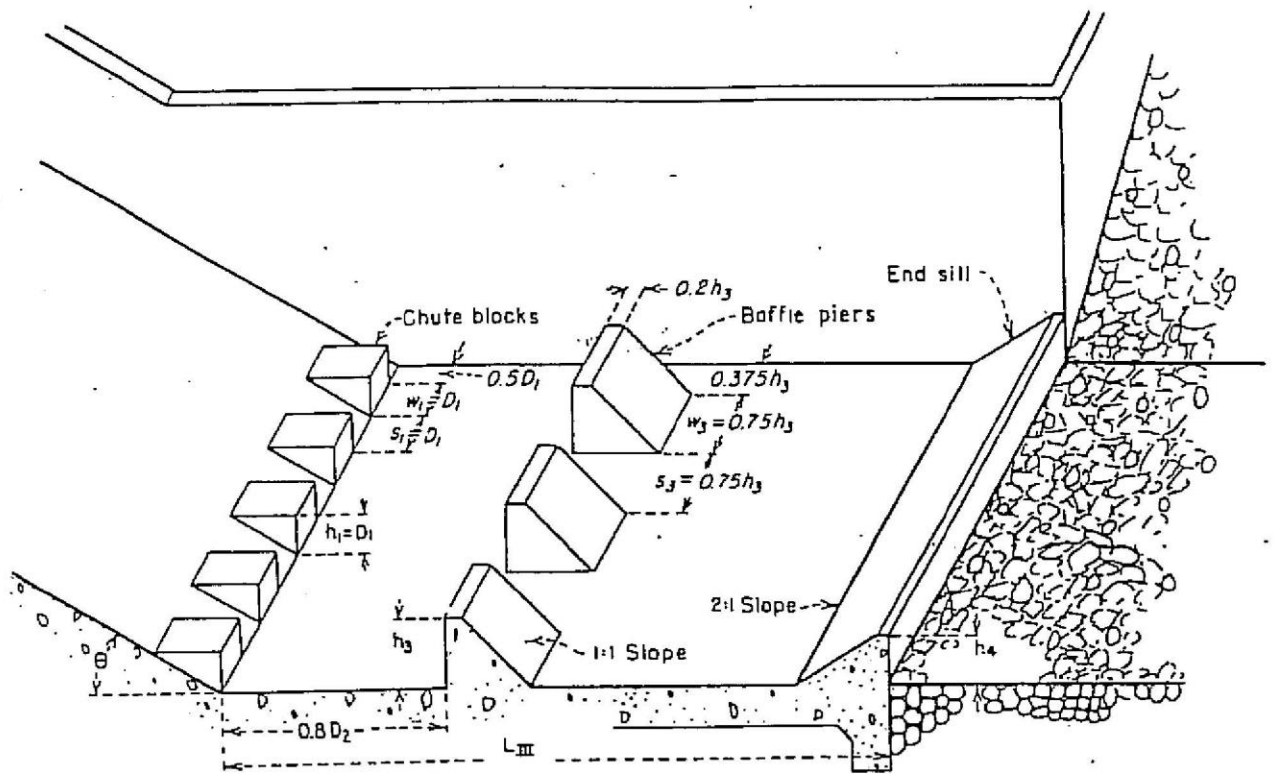

Note: See Figure 4.5 for design data

Source: "Hydraulic Design of Stilling Basins and Energy Dissipators", EM25 BR, January 1978

USBR TYPE III
STILLING BASIN

Figure 4

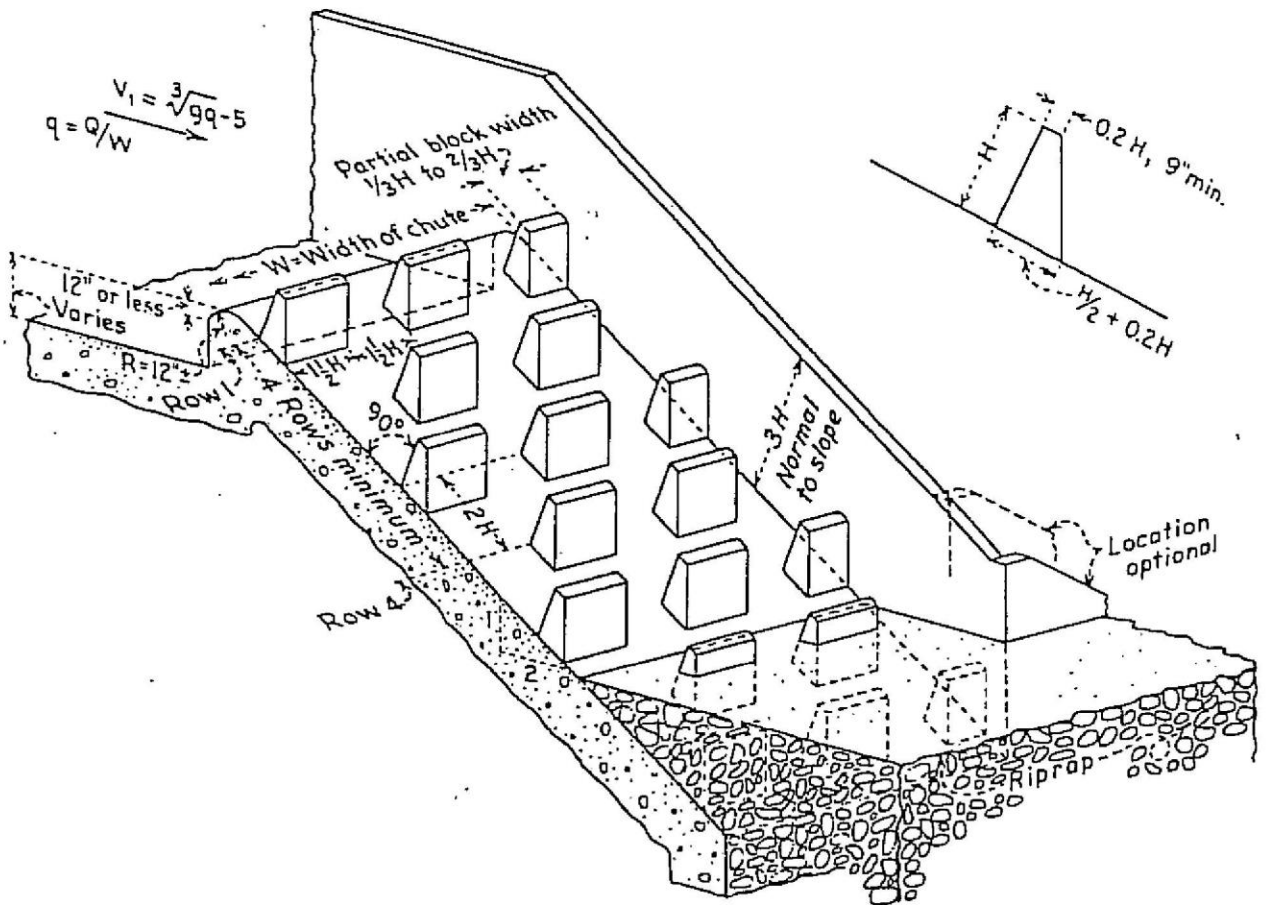

Note: See Figure 4.5 for design data

Source: "Hydraulic Design of Stilling Basins and Energy Dissipators", EM25 BR. January 1978

USBR TYPE IX
STILLING BASIN

Figure 4.3

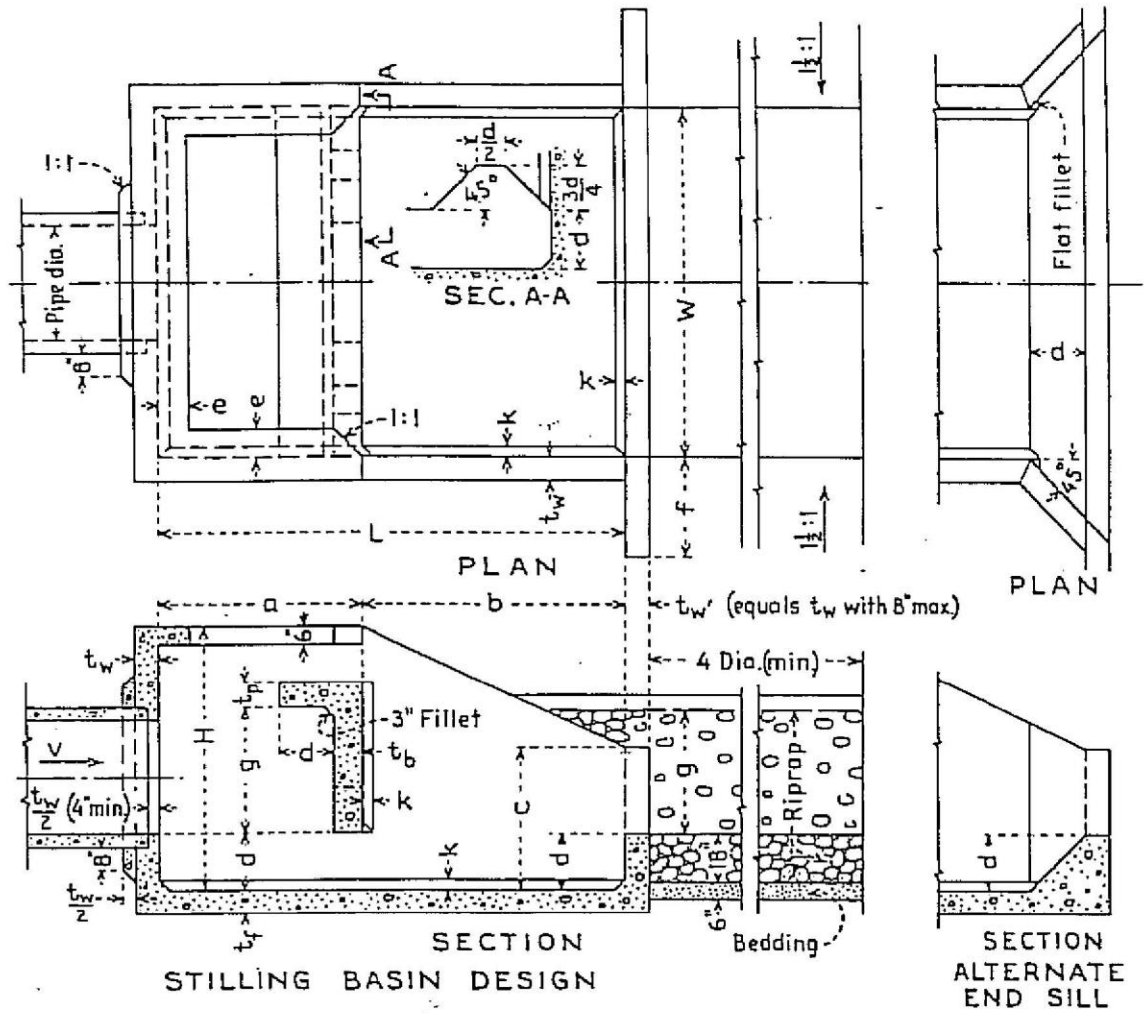

Note: 1. See Figure 4.5 for design data
 2. Refer to source for structural details

Source: "Design of Small Canal Structures"
 USDI, BR, Denver 1974

USBR TYPE VI
 STILLING BASIN

Figure 4.4

SHORT STILLING BASINS FOR CANAL STRUCTURES, SMALL OUTLET WORKS AND SMALL SPILLWAYS (BASIN III)

Jump and basin length reduced about 60 percent with chute blocks, baffle piers, and solid end sill.
 For use on small spillways, outlet works, small canal structures where V_1 does not exceed 50-60 feet per second and Froude number is above 4.5.

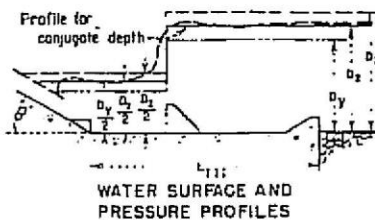
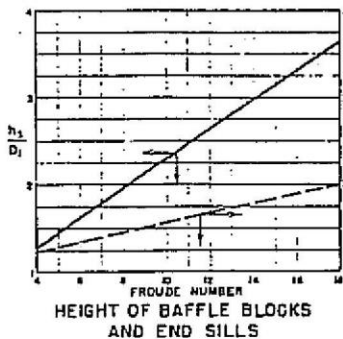
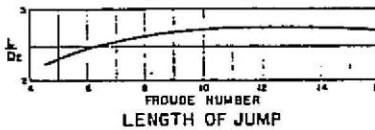
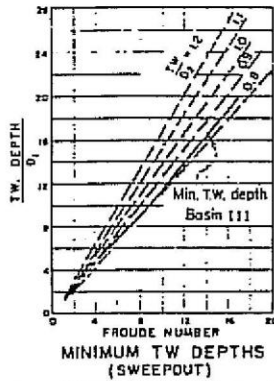
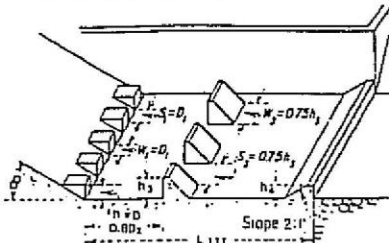

STILLING BASIN FOR PIPE ON OPEN CHANNEL OUTLET (BASIN VI)

For use on pipe or open channel outlets. Sizes and discharges from table V_1 should not exceed 30 feet per second. No tailwater required. Froude number usually 1.5 to 7 but not important. May substitute for Basin IV. Energy loss greater than in comparable jump, Figure 4.4.

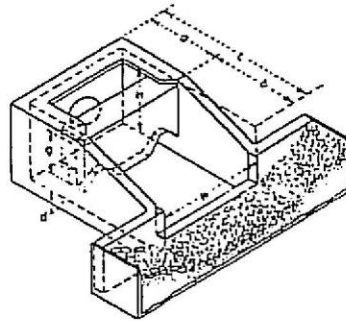

PIPE DIA IN	AREA SQ FT	FEET AND INCHES								
		O	W	H	L	a	b	C	C	Q
18	1.77	21	3-6	4-3	7-4	3-3	4-1	2-4	0-11	2-1
24	3.14	38	6-8	5-3	9-0	3-11	5-4	2-0	1-2	2-6
30	4.91	59	8-0	6-3	10-9	4-7	6-4	3-4	1-4	3-0
36	7.07	83	9-3	7-3	12-4	5-3	7-1	3-10	4-7	3-6
42	9.62	115	10-6	8-0	14-0	6-0	8-0	4-5	1-9	3-11
48	12.57	151	11-9	9-0	15-8	6-9	8-11	4-11	2-0	4-3
54	15.90	191	13-0	9-9	17-4	7-4	10-0	5-3	2-2	4-11
60	19.63	234	14-3	10-9	19-0	8-0	11-0	5-11	2-3	3-4
72	28.27	339	16-6	12-3	22-0	9-3	12-9	6-11	2-9	6-2

BASIC DIMENSIONS

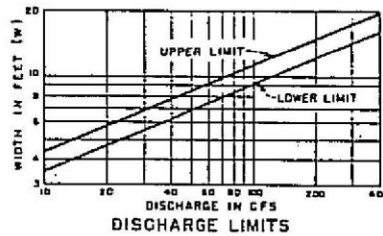

DISCHARGE LIMITS

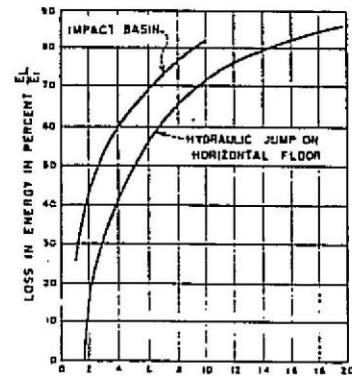

COMPARISON OF ENERGY LOSSES

BAFFLED APRON FOR CANAL OR SPILLWAY DROPS (BASIN IX)

For use in flow ways where water is to be lowered from one level to another. The baffle piers prevent undue acceleration of the flow as it passes down the chute. Since the flow velocities entering the downstream channel are relatively low, no stilling basin is required. The chute may be designed to discharge up to 60 cubic feet per second per foot of width and the drop may be as high as structurally feasible.

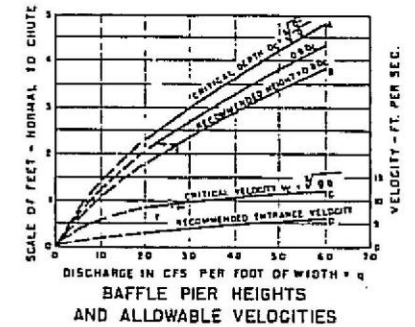
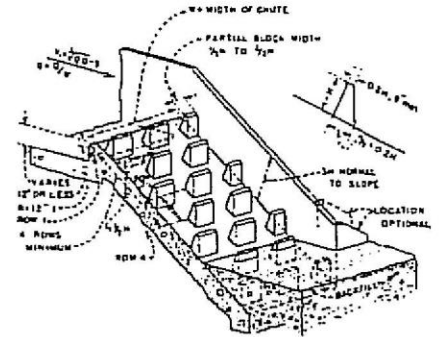

SIMPLIFIED DESIGN PROCEDURE

The baffled apron should be designed for the maximum expected discharge, Q , up to 60 c.f.s. per foot of width.
 Entrance velocity V_1 should be as low as practical or $V_1 = \sqrt{gD}$.
 See Figures 103, 105, 107 and 109 for sample approach pools.
 Baffle pier height, H , should be about $0.8D_2$ to $0.9D_2$, Curve B above.
 Baffle pier widths and spaces should be equal, up to $1/2 H$, but not less than H .
 The slope distance between rows of baffle piers should be $2H$, twice the baffle height H . See text for increase in row spacing on flat chutes.
 Four rows of baffle piers are required to establish full control of the flow, although fewer rows have operated successfully. At least one row of baffles should be buried in the backfill.
 The chute training walls should be three times as high as the baffle piers.
 Riprap consisting of 6- to 12-inch stones should be placed at the downstream ends of training walls to prevent eddies from undermining the walls.

Source: "Hydraulic Design of Stilling Basins and Energy Dissipators", EM25 BR, January 1978

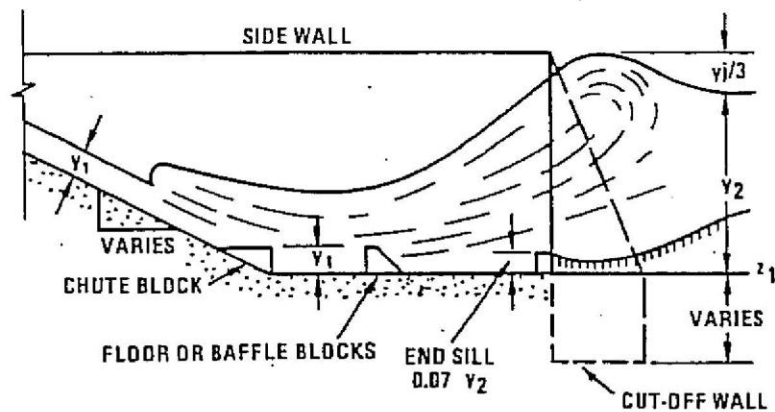
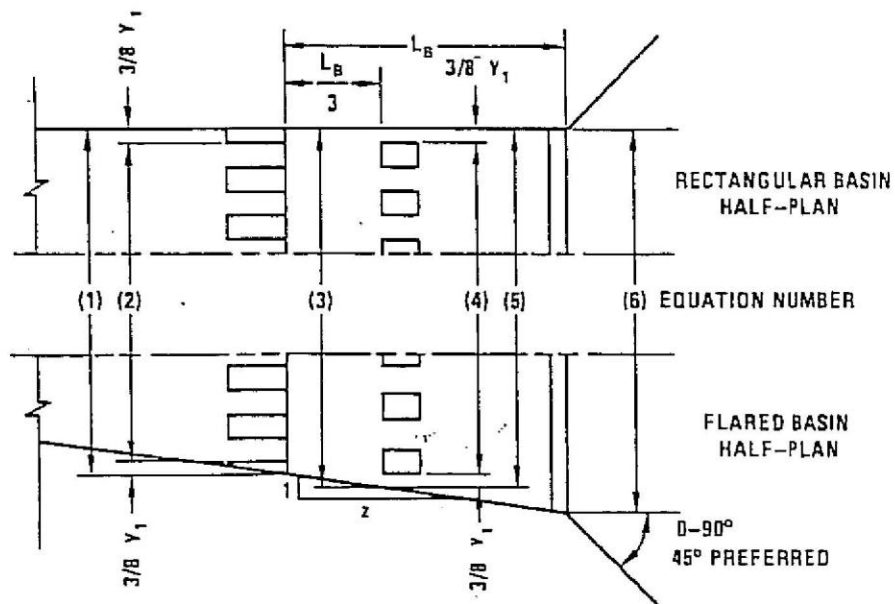

- (1) W_B = BASIN WIDTH UPSTREAM
- (2) n BLOCKS AT $3/4 y_1 \pm$
- (3) $0.40 W_{B2} \leq$ AGGREGATE BLOCK WIDTH $\leq 0.55 W_{B2}$
- (4) n BLOCKS AT $3/4 y_1 \frac{W_{B2}}{W_B} \pm$
- (5) $W_{B2} = W_B + 2L_B/3z$
- (6) $W_{B3} = W_B + 2L_B/z$

Source: "Hydraulic Design of Energy Dissipator for Culverts and Channels" HEC-14, FHWA, 1975

SAF TYPE
STILLING BASIN

Figure 4

Type 1
Culvert Flowing Part Full
With Outlet Control and Tailwater Depth
Below Critical Depth

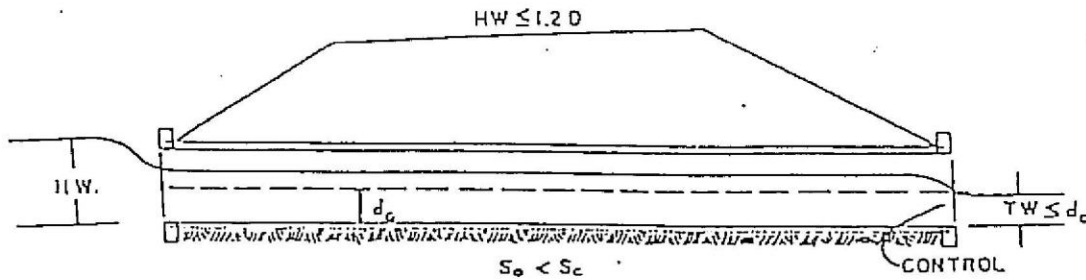

Conditions

The entrance is unsubmerged ($HW \leq 1.2D$), the slope at design discharge is sub-critical ($S_o < S_c$), and the tailwater is below critical depth ($TW \leq d_c$).

The above condition is a common occurrence where the natural channels are on flat grades and have wide, flat flood plains. The control is critical depth at the outlet.

In culvert design, it is generally considered that the headwater pool maintains a constant level during the design storm. If this level does not submerge the culvert inlet, the culvert flows part full.

If critical flow occurs at the outlet the culvert is said to have "Outlet Control." A culvert flowing part full with outlet control will require a depth of flow in the barrel of the culvert greater than critical depth while passing through critical depth at the outlet.

The capacity of a culvert flowing part full with outlet control and tailwater depth below critical depth shall be governed by the following equation when the approach velocity is considered zero.

$$HW = d_c + \frac{V_c^2}{2g} + h_e + h_f + S_o L$$

HW = Headwater depth above the invert of the upstream end of the culvert in feet. Headwater must be equal to or less than $1.2D$ or entrance is submerged and Type 4 operation will result.

d_c = Critical depth of flow in feet = $\sqrt[3]{\frac{q^3}{32.2}}$

D = Diameter of pipe or height of box.

q = Discharge in cfs per foot.

V_c = Critical velocity in feet per second occurring at critical depth.

h_e = Entrance head loss in feet.

$$h_e = K_e \left(\frac{V_c^2}{2g} \right)$$

K_e = Entrance loss coefficient.

h_f = Friction head loss in feet = $S_f L$.

S_f = Friction slope or slope that will produce uniform flow. For Type 1 operation the friction slope is based upon $1.1 d_c$.

S_o = Slope of culvert in feet per foot.

L = Length of culvert in feet.

Source: City of Austin, TX

Type II
 Culvert Flowing Part Full
 With Outlet Control And Tailwater Depth
 Above Critical Depth

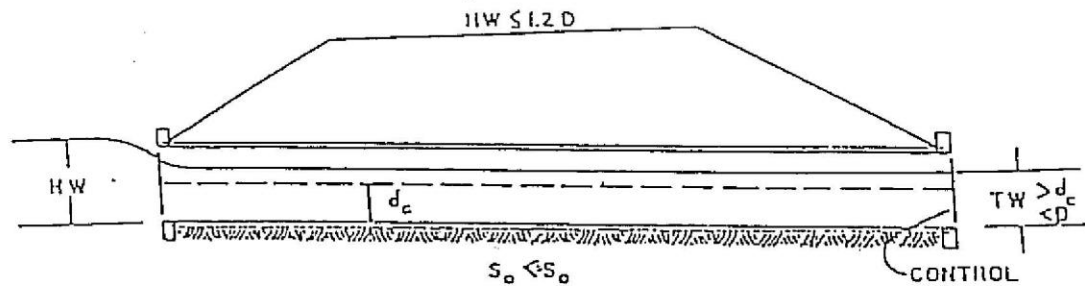

Conditions

The entrance is unsubmerged ($HW \leq 1.2D$), the slope at design discharge is subcritical ($S_o < S_c$), and the tailwater is above critical depth ($TW > d_c$).

The above condition is a common occurrence where the channel is deep, narrow and well defined.

If the headwater pool elevation does not submerge the culvert inlet, the slope at design discharge is subcritical, and the tailwater depth is above critical depth the control is said to occur at the outlet; and the capacity of the culvert shall be governed by the following equation when the approach velocity is considered zero.

$$HW = TW + \frac{V_{TW}^2}{2g} + h_e + h_f + S_o L$$

HW = Headwater depth above the invert of the upstream end of the culvert in feet. Headwater depth must be equal to or less than 1.2D or entrance is submerged and Type IV operation will result.

TW = Tailwater depth above the invert of the downstream end of the culvert in feet.

V_{TW} = Culvert discharge velocity in feet per second at tailwater depth.

h_e = Entrance head loss in feet.

$$h_e = K_e \left(\frac{V_{TW}^2}{2g} \right)$$

K_e = Entrance loss coefficient

h_f = Friction head loss in feet = $S_f L$

S_f = Friction slope or slope that will produce uniform flow. For Type II operation the friction slope is based upon TW depth.

S_o = Slope culvert in feet per foot.

L = Length of culvert in feet.

Source: City of Austin, TX

Type III

Culvert Flowing Part Full With Inlet Control

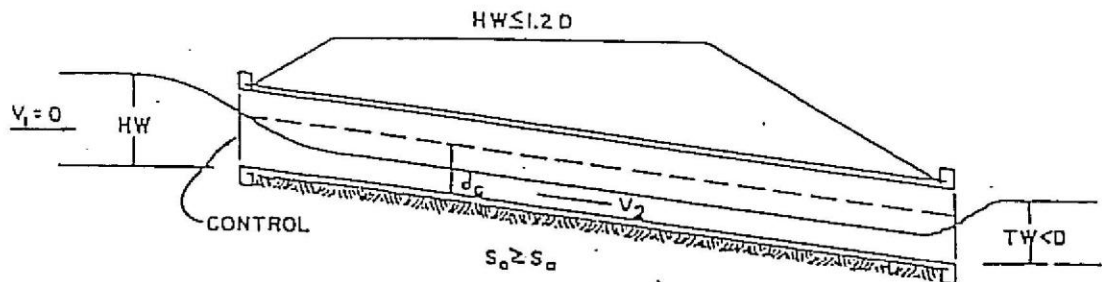

Conditions

The entrance is unsubmerged ($HW \leq 1.2D$) and the slope at design discharge is equal to or greater than critical (Supercritical) ($S_o \geq S_c$).

This condition is a common occurrence for culverts in rolling or mountainous country where the flow does not submerge the entrance. The control is critical depth at the entrance.

If critical flow occurs near the inlet, the culvert is said to have "Inlet Control". The maximum discharge through a culvert flowing part full occurs when flow is at critical depth for a given energy head. To assure that flow passes through critical depth near the inlet, the culvert must be laid on a slope equal to or greater than critical slope for the design discharge. Placing culverts which are to flow part full on slopes greater than critical slope will increase the outlet velocities but will not increase the discharge. The discharge is limited by the section near the inlet at which critical flow occurs.

The capacity of a culvert flowing part full with control at the inlet shall be governed by the following equation when the approach velocity is considered zero.

$$HW = d_c + \frac{V_2^2}{2g} + K_e \frac{V_2^2}{2g}$$

HW = Headwater depth above the invert of the upstream end of the culvert in feet. Headwater depth must be equal to or less than $1.2D$ or entrance is submerged and Type IV operation will result.

d_c = Critical depth of flow in feet = $\sqrt[3]{\frac{q^2}{32.2}}$

q = Discharge in cfs per foot.

V_2 = Velocity of flow in the culvert in feet per second.

The velocity of flow varies from critical velocity at the entrance to uniform velocity at the outlet provided the culvert is sufficiently long. Therefore, the outlet velocity is the discharge divided by the area of flow in the culvert.

K_e = Entrance loss coefficient

Source: City of Austin, TX

Type IV-A

Culvert Flowing Full With Submerged Outlet

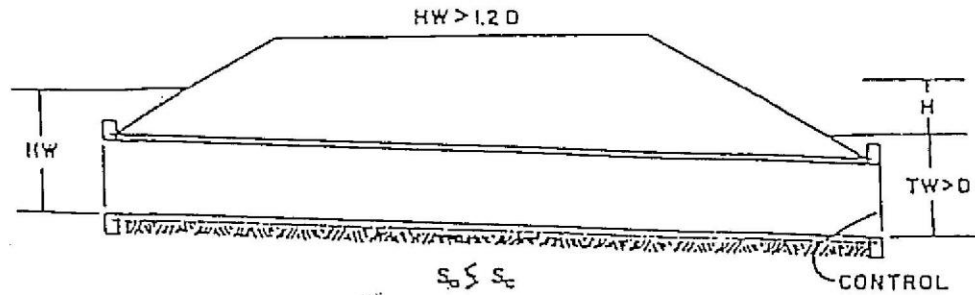

Conditions

(Submerged Outlet)

The entrance is submerged ($HW > 1.2D$). The tailwater completely submerges the outlet.

Most culverts flow with free outlet, but depending on topography, a tailwater pool of a depth sufficient to submerge the outlet may form at some installation. Generally, these will be considered at the outlet. For an outlet to be submerged, the depth at the outlet must be equal to or greater than the diameter of pipe or height of box. The capacity of a culvert flowing full with a submerged outlet shall be governed by the following equation when the approach velocity is considered zero. Outlet Velocity is based on full flow at the outlet.

$$HW = H + TW - S_o L$$

HW = Headwater depth above the invert of the upstream end of the culvert. Headwater depth must be greater than 1.2D for entrance to be submerged.

H = Head for culvert flowing full.

TW = Tailwater depth in feet.

S_o = Slope of culvert in feet per foot.

L = Length of culvert in feet.

Source: City of Austin, TX

Type IV-B
Culvert Flowing Full
With Partially Submerged Outlet

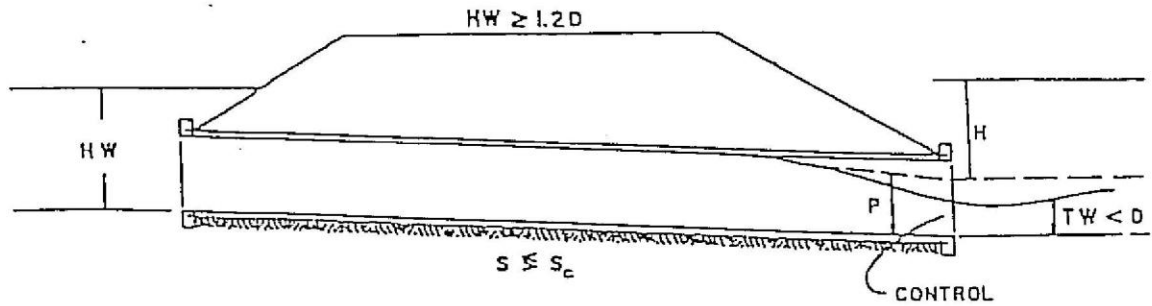

Conditions

(Partially Submerged Outlet)

The entrance is submerged ($HW > 1.2D$). The tailwater depth is less than D ($TW < D$).

The capacity of a culvert flowing full with a partially submerged outlet shall be governed by the following equation when the approach velocity is considered zero. Outlet velocity is based on critical depth if TW depth is less than critical depth. If TW depth is greater than critical depth, outlet velocity is based on TW depth.

$$HW = H + P - S_o L$$

HW = Headwater Depth above the invert of the upstream end of the culvert. Headwater depth must be greater than $1.2D$ for entrance to be submerged.

H = Head for culverts flowing full.

P = Pressure line height = $\frac{d_c + D}{2}$

d_c = Critical depth in feet.

D = Diameter or height of structure in feet.

S_o = Slope of culvert in feet per foot.

L = Length of culvert in feet.

Source: City of Austin, TX

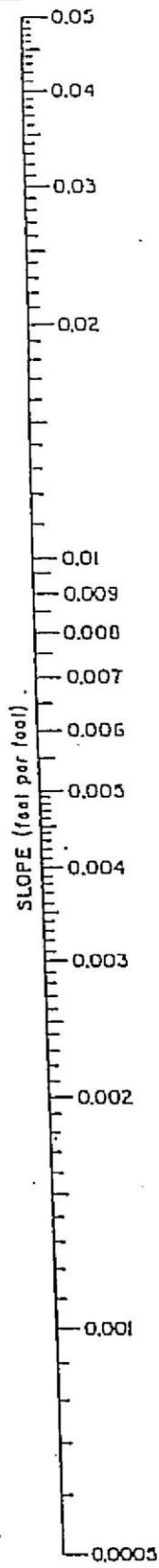

3 SIDES WETTED
n = 0.012

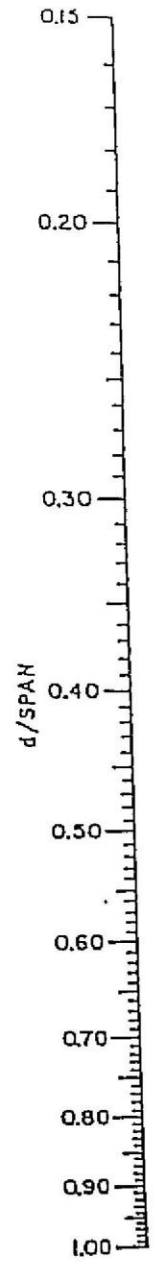
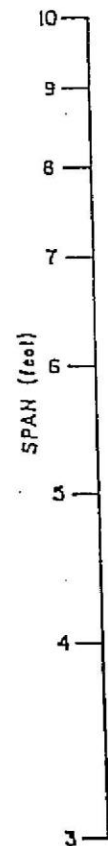

UNIFORM FLOW FOR BOX CULVERTS

Source: Texas Highway Department

Figure 4.12

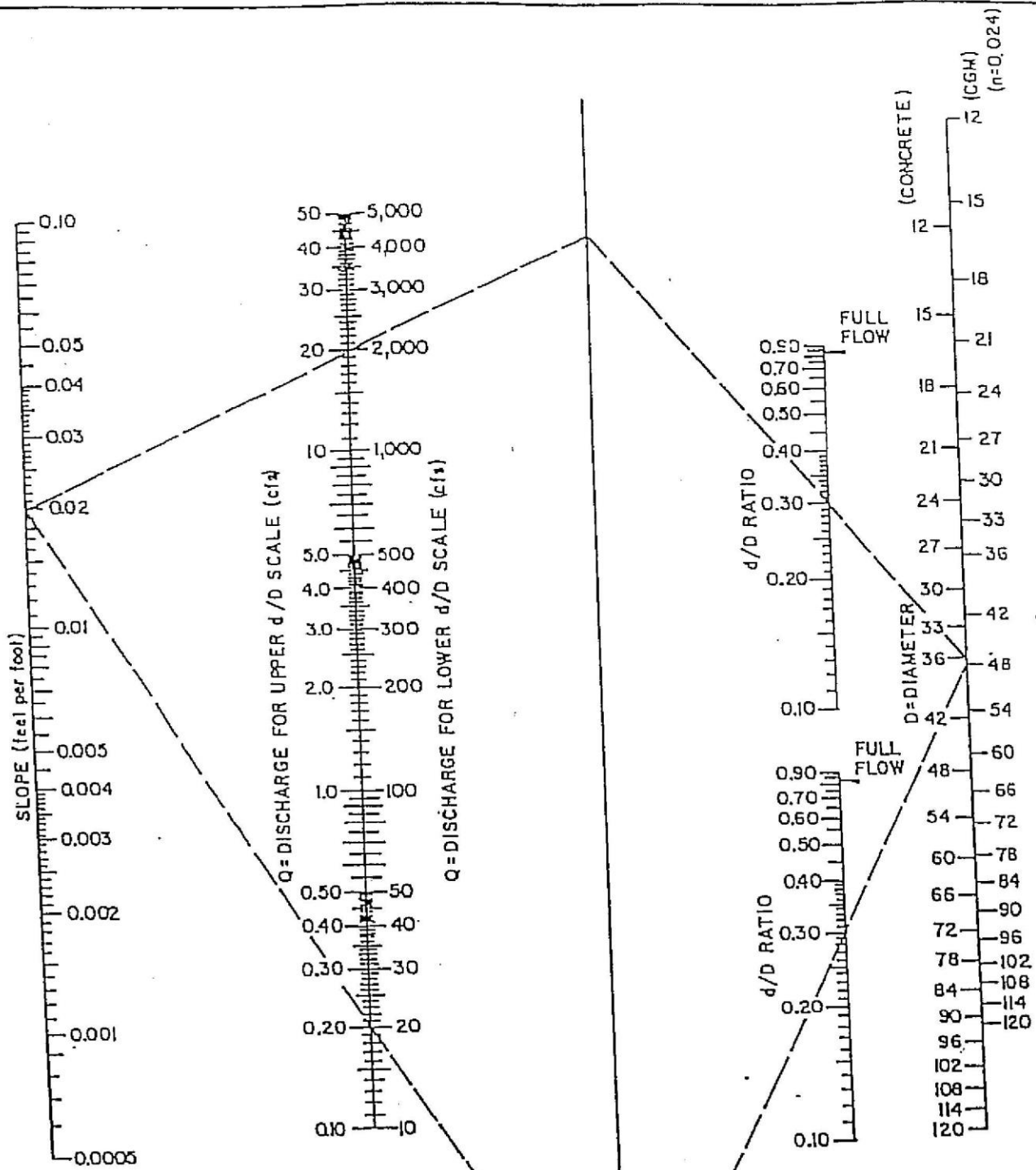

EXAMPLE

GIVEN: $S = 0.02$ FIND: $d/D =$
 $Q = 20$ cfs $d =$
 $D = 36''$ (CONCRETE)

SOLUTION

$d/D = 0.30$
 $d = 0.30 \times 3' = 0.9'$

UNIFORM FLOW FOR PIPE CULVERTS

Source: Texas Highway Department

Figure 4.13

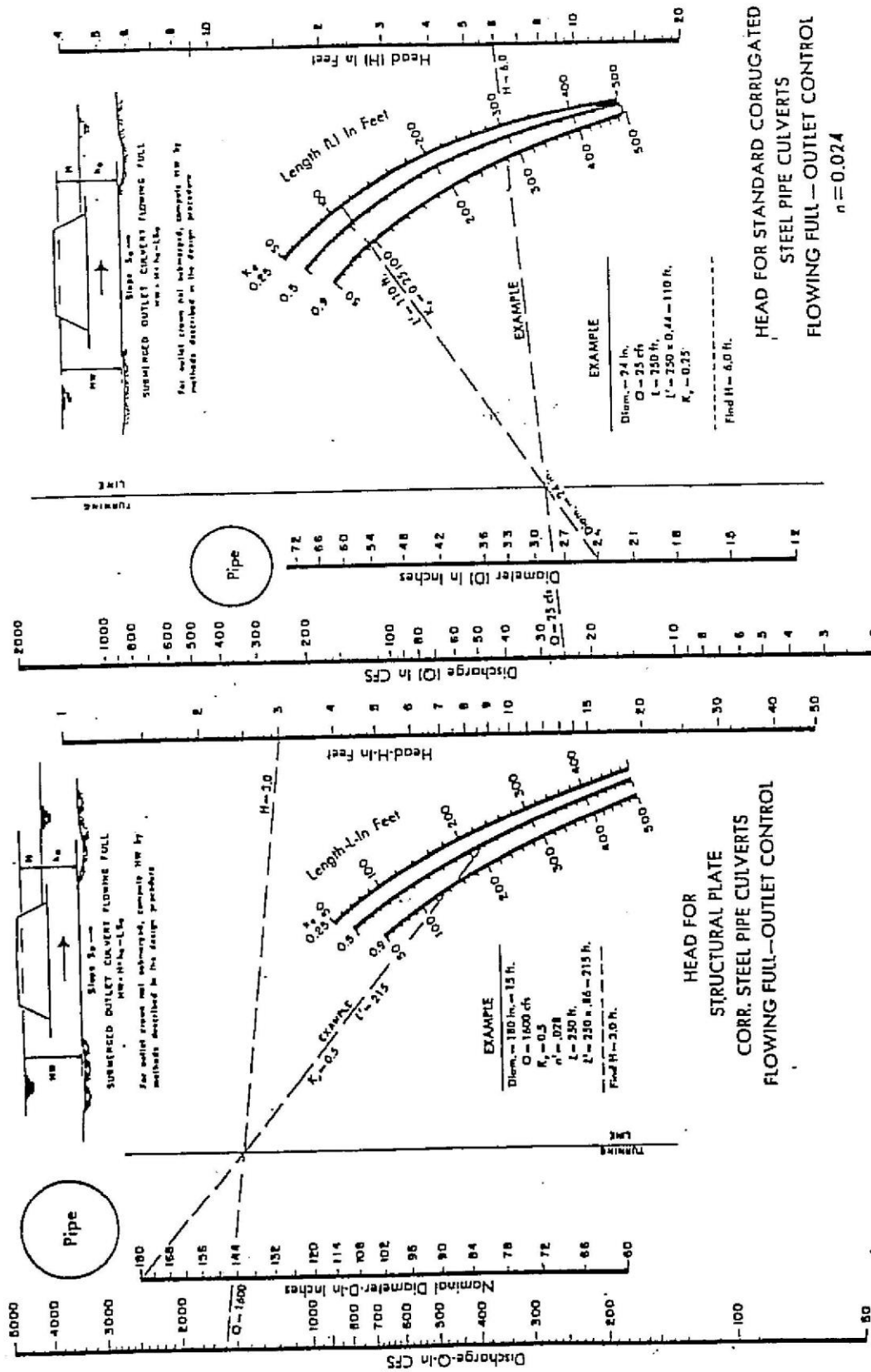

SOURCE: "HANDBOOK OF STEEL DRAINAGE & HIGHWAY CONSTRUCTION PRODUCTS", AISI 1971

Length Adjustment for Improved Hydraulics

Pipe Diam. In Feet	Roughness Factor		Length Adjustment Factor $\left(\frac{n'}{n}\right)^2$
	Curves Based on n_m	Actual n'_{max}	
5'	.0328	.033	1.0
7'	.0320	.032	1.0
10'	.0311	.030	0.93
15'	.0301	.028	0.86

OUTLET CONTROL NOMOGRAPH CIRCULAR CSP

Figure 4

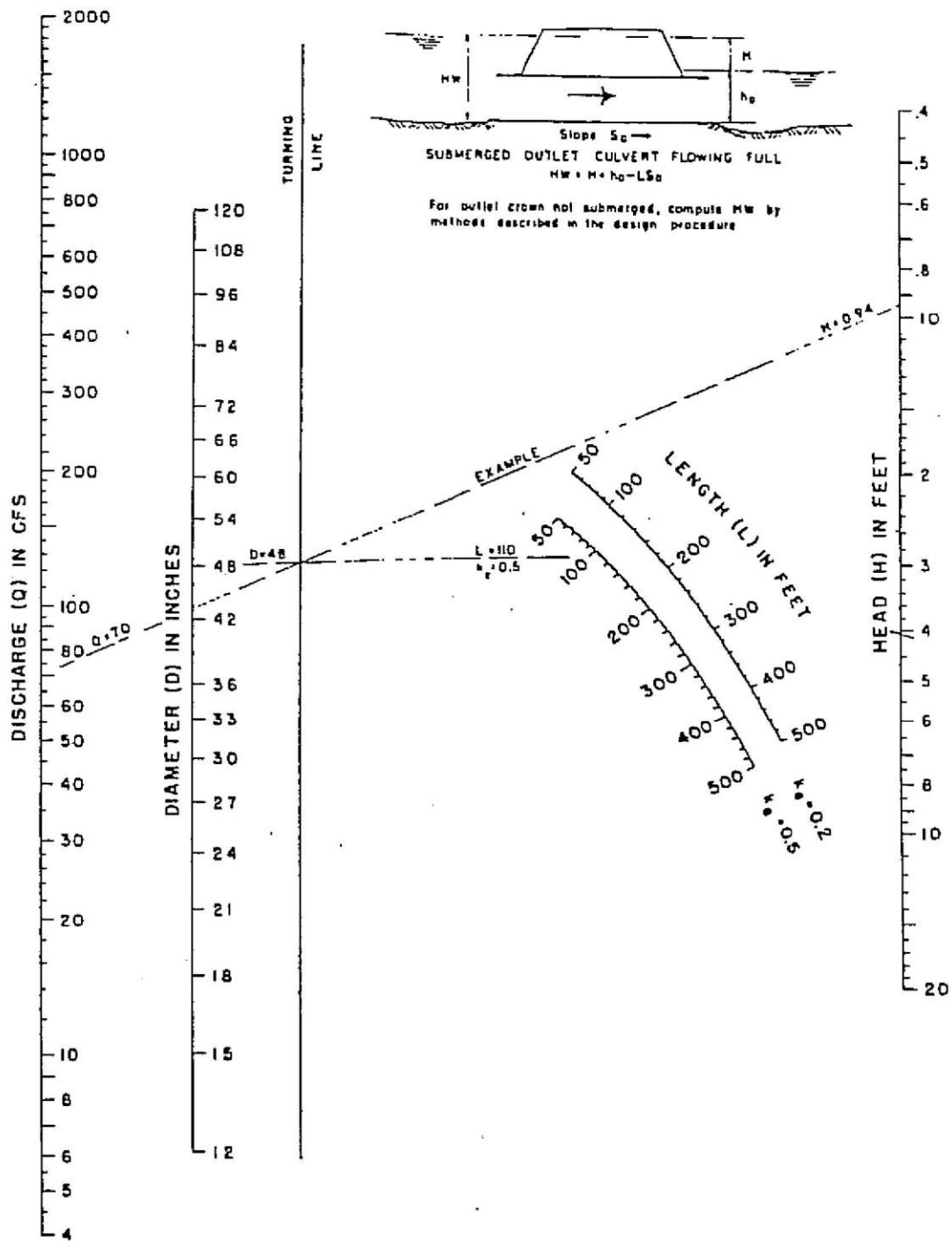

SOURCE: "HYDRAULIC CHARTS FOR THE SELECTION OF HIGHWAY CULVERTS", HEC-5, USDOT, FHA, DEC. 1965

OUTLET CONTROL NOMOGRAPH
CIRCULAR RCP

Figure 4.15

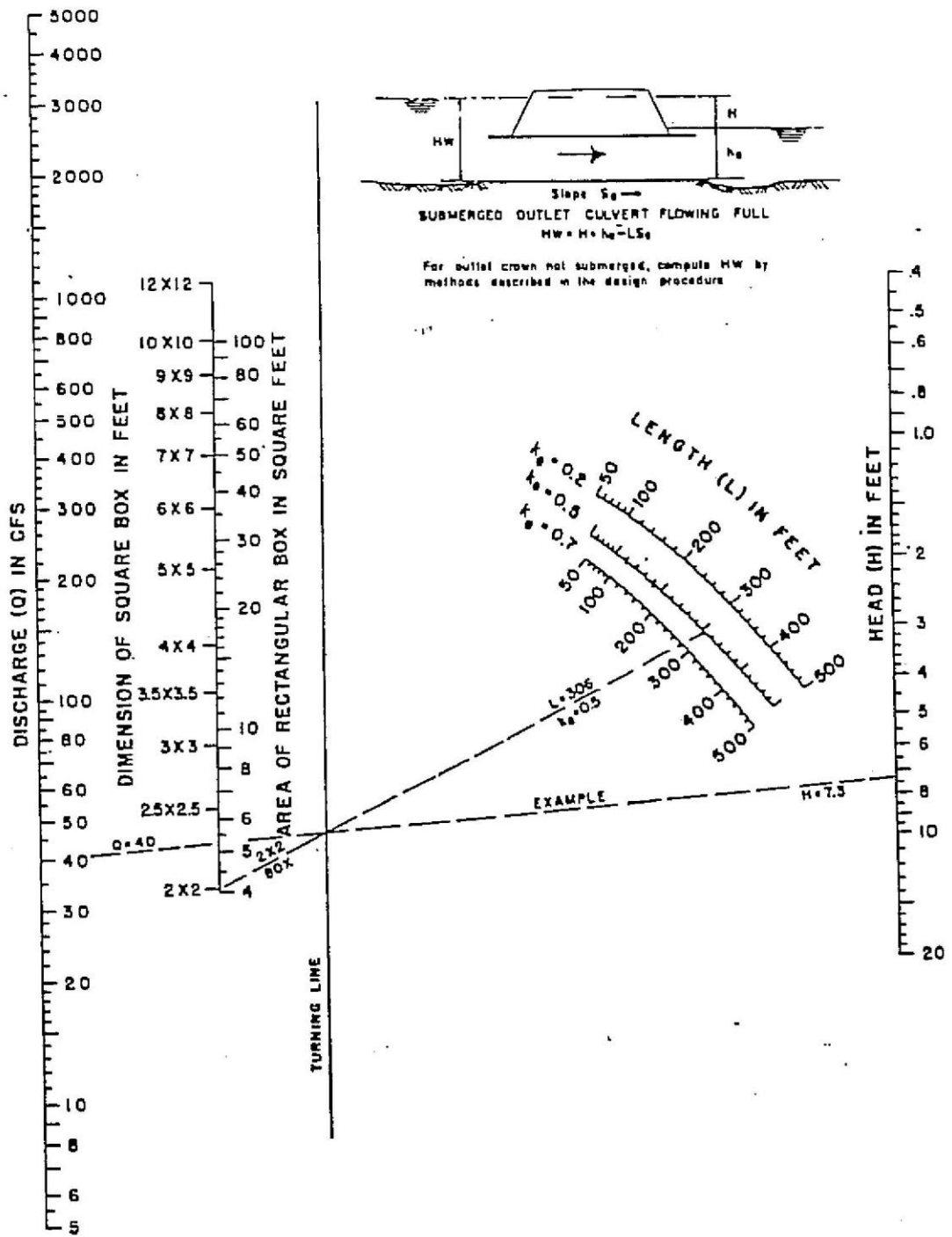

SOURCE: "HYDRAULIC CHARTS FOR THE SELECTION OF HIGHWAY CULVERTS", HEC-5, USDOT, FHA, DEC. 1965

OUTLET CONTROL NOMOGRAPH
BOX CULVERTS

Figure 4.1

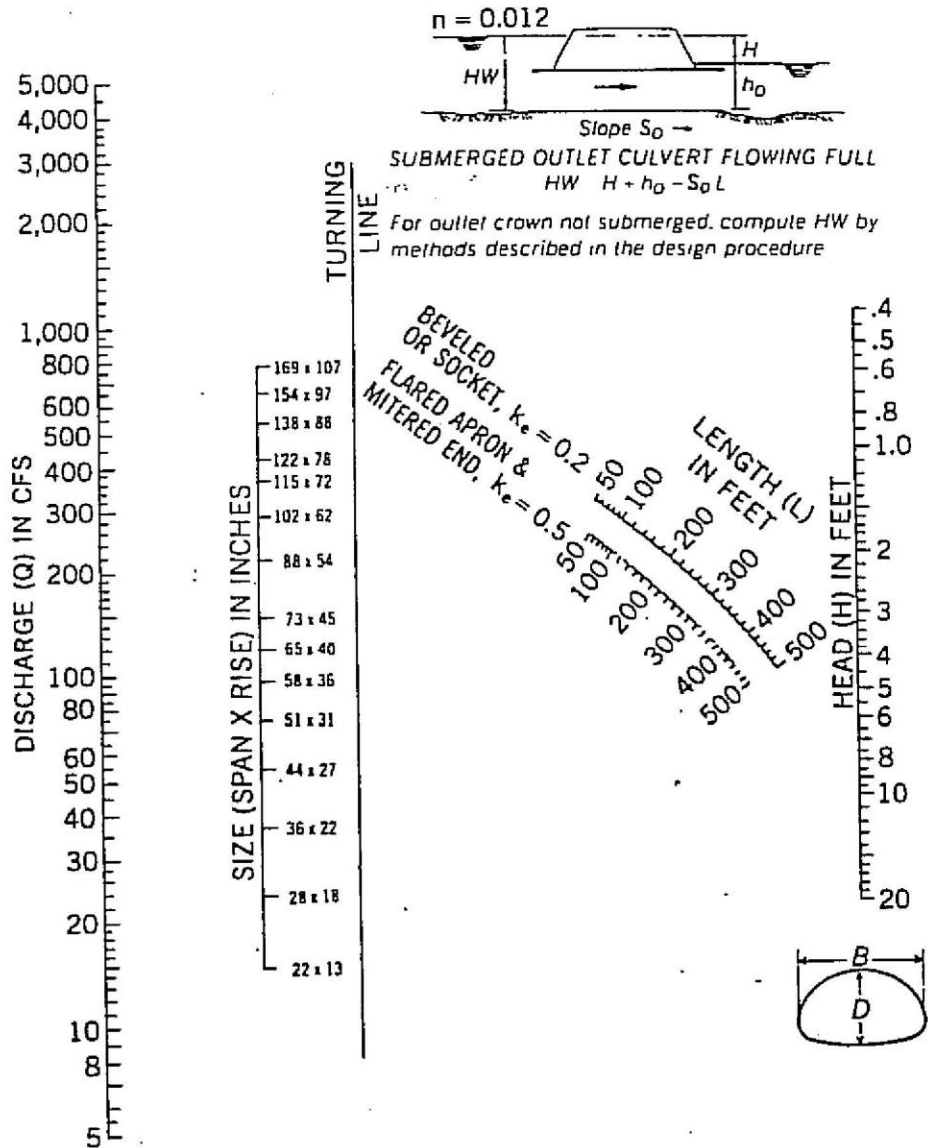

SOURCE: "CONCRETE PIPE DESIGN MANUAL", ACPA 1970

OUTLET CONTROL NOMOGRAPH
RCP ARCH

Figure 4.1

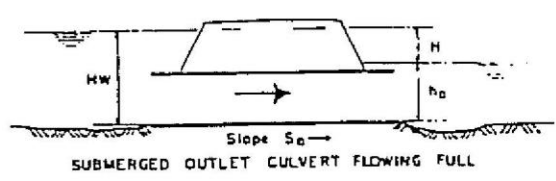
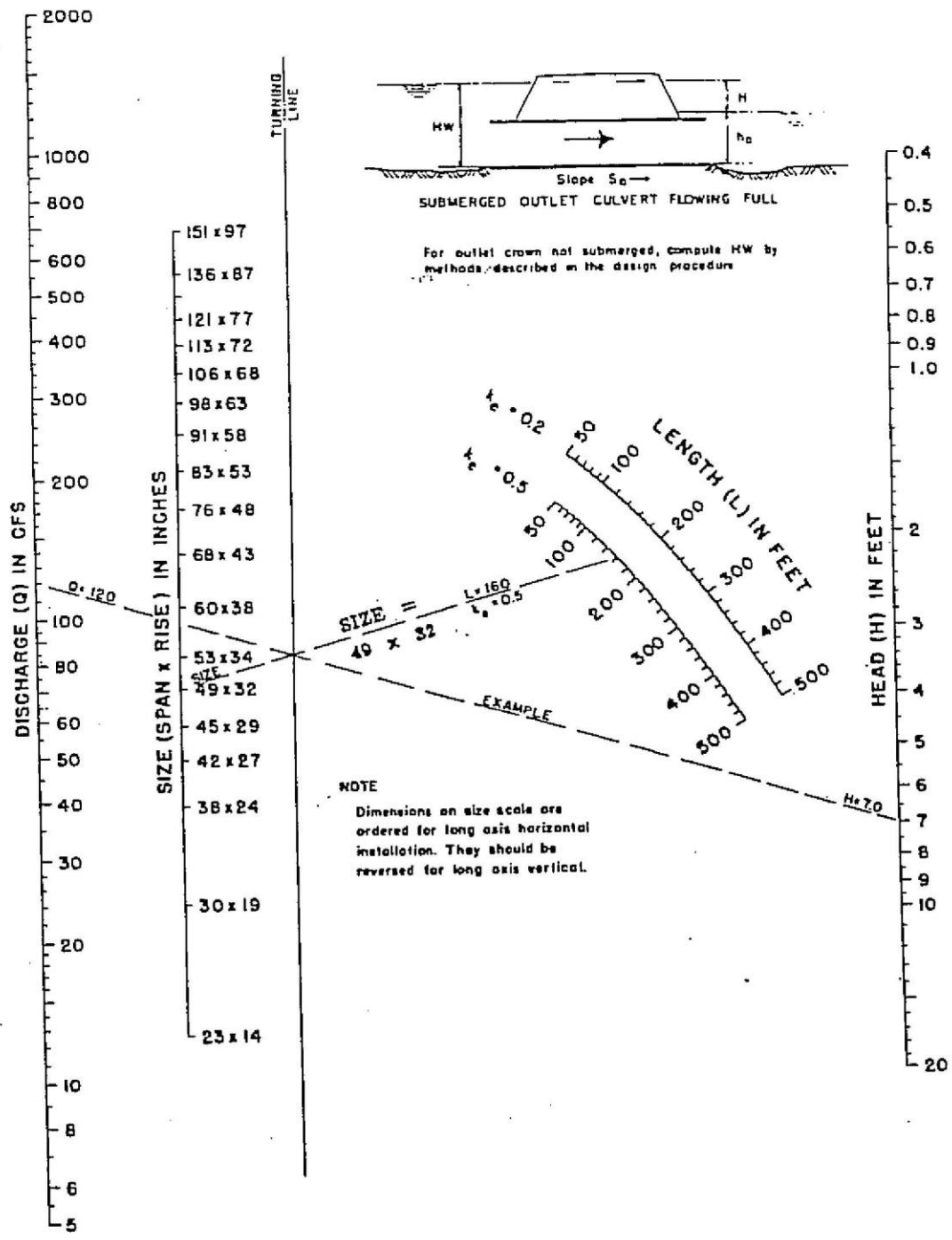

For outlet crown not submerged, compute HW by methods described in the design procedure.

NOTE
Dimensions on size scale are ordered for long axis horizontal installation. They should be reversed for long axis vertical.

SOURCE: "HANDBOOK OF STEEL DRAINAGE & HIGHWAY CONSTRUCTION PRODUCTS", AISI 1971

OUTLET CONTROL NOMOGRAPH
RCP ELLIPSE

Figure 4.2

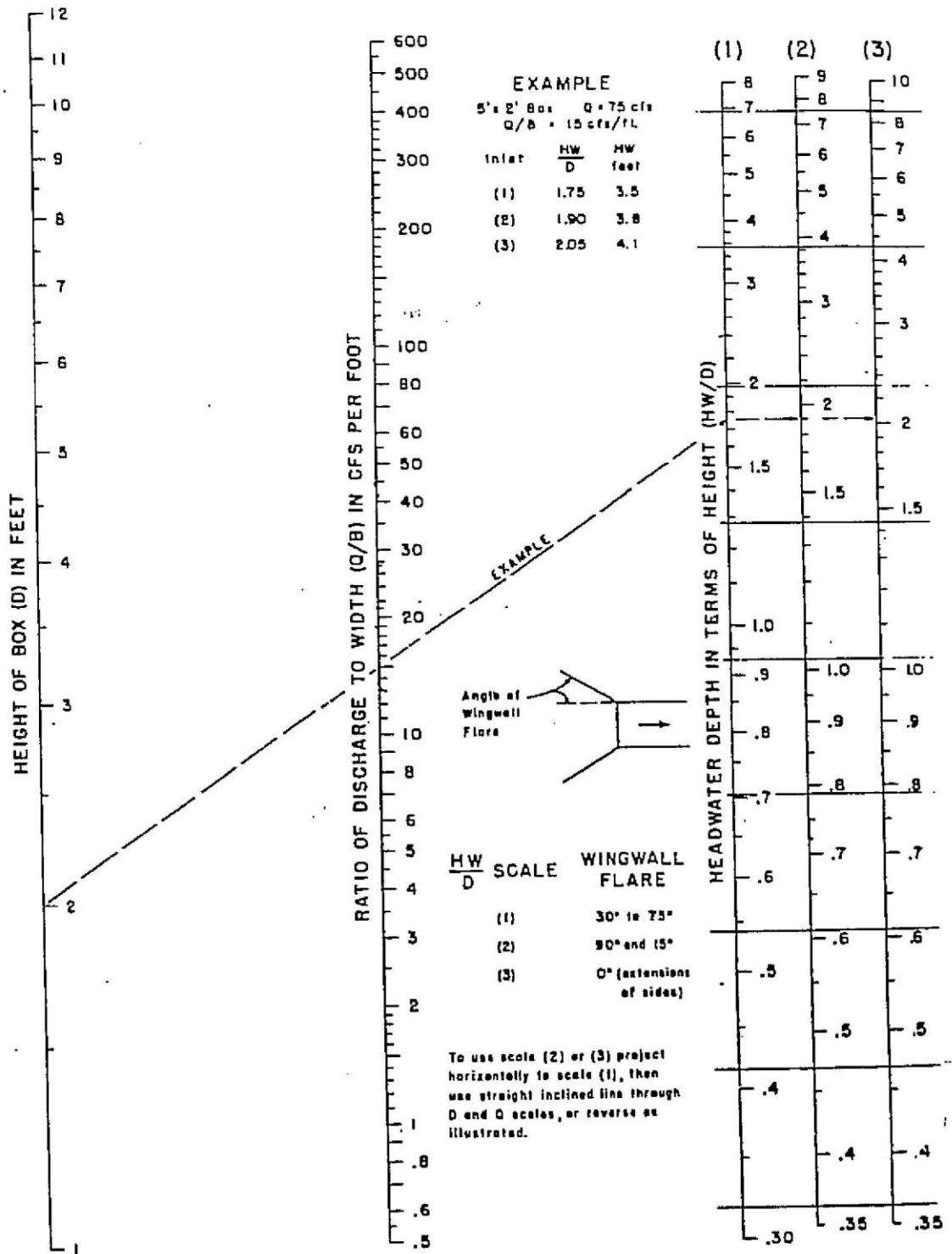

SOURCE: "HYDRAULIC CHARTS FOR THE SELECTION OF HIGHWAY CULVERTS", HEC-5, USDOT, FHA, DEC. 1965

INLET CONTROL NOMOGRAPH
 BOX CULVERTS

Figure 4.2

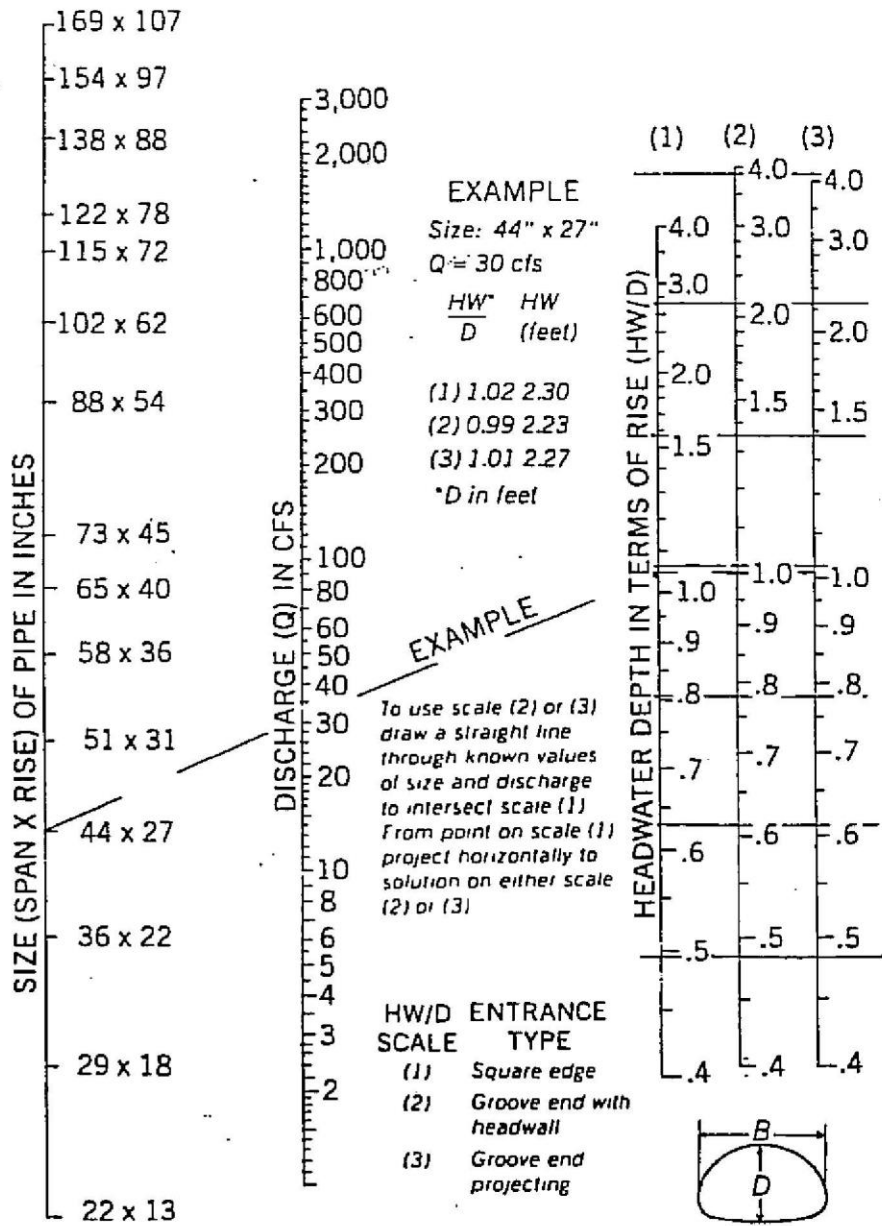

SOURCE: "CONCRETE PIPE DESIGN MANUAL", ACPA 1970

INLET CONTROL NOMOGRAPH
RCP ARCH

Figure 4

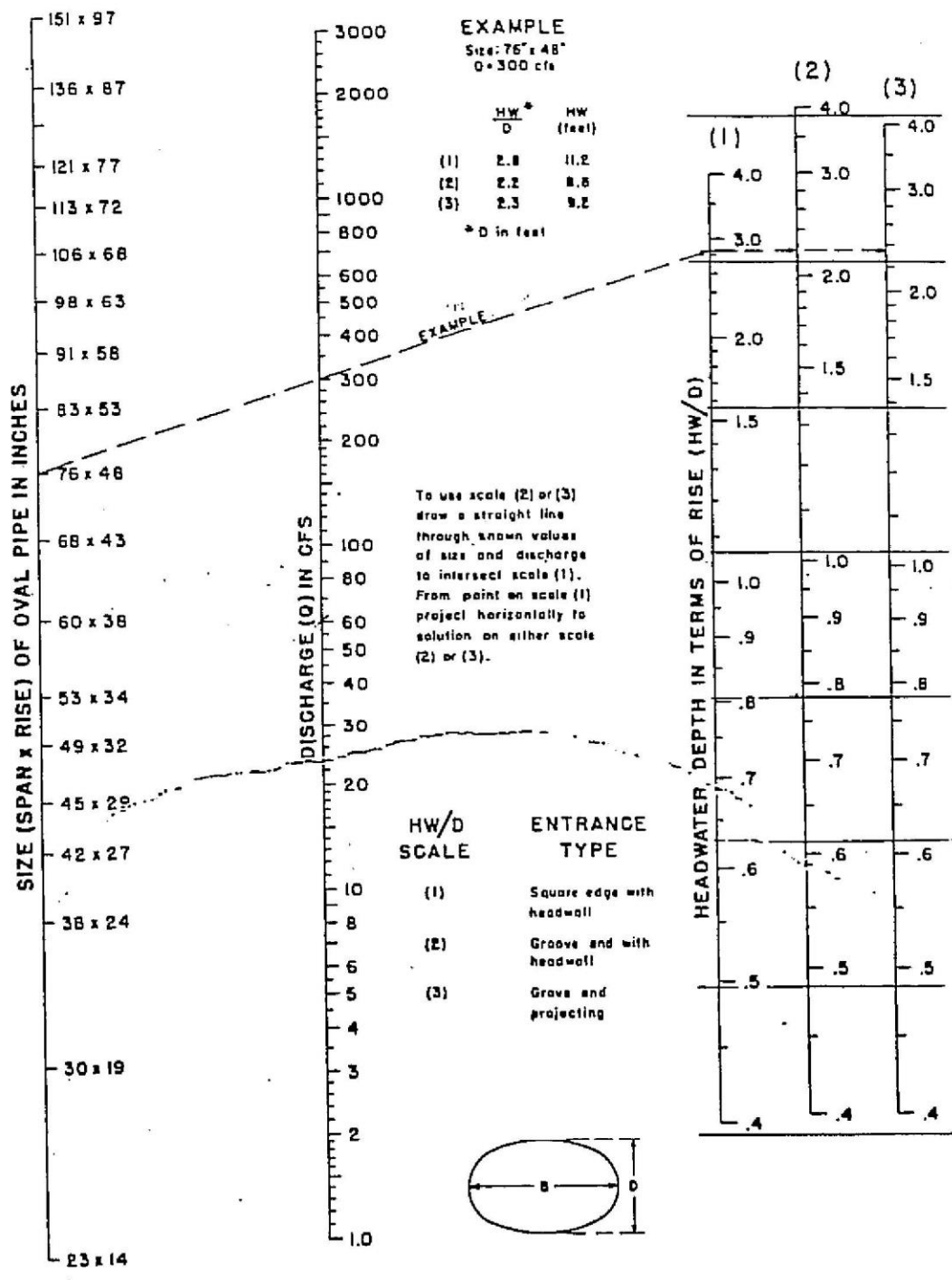

SOURCE: "HYDRAULIC CHARTS FOR THE SELECTION OF HIGHWAY CULVERTS", HEC-5, USDOT, FHA, DEC. 1965

INLET CONTROL NOMOGRAPH
 RCP ELLIPSE

Figure 4.2

TABLE OF CONTENTS - SECTION 5

SECTION 5 - STORMWATER DETENTION

5.1	General
5.2	Volume of Detention
5.3	Design Criteria
5.4	Method of Detention
5.4.1	General Location
5.4.2	Dry Reservoirs
5.4.3	Permanent Lakes
5.4.4	Parking Lots
5.4.5	Other Methods
5.4.6	Verification of Adequacy
5.4.7	Outlet Works
5.4.8	Discharge Systems
5.4.9	Ownership of Stormwater Detention Ponds
5.4.10	Easements
5.4.11	Maintenance
5.5	Detention Basin Design Procedure (Using the Modified Rational Method)
5.6	Stormwater Detention Analysis Software
5.6.1	Pond-2
5.6.2	HEC-HMS
Exhibit 5-1	Modified Rational Method Detention Basin Design Manual Procedure
Exhibit 5-2	Pond-2 Detention Design Procedure

SECTION 5 - STORMWATER DETENTION

5.1 GENERAL

If hydrologic and hydraulic studies reveal that the proposed development would cause increased flood stages that would increase the flood damages to existing developments or property, or increase flood elevations beyond the vertical limits set for the floodplain districts, then the grading or construction permit applications shall be denied unless one or more of the following mitigations measures are used subject to Planning Commission approval: (1) Onsite storage, (2) offsite storage, or (3) improve the downstream drainage system.

Stormwater runoff and the velocity of discharge are considerably increased as a result of development and growth of the City. Prior to the development of land, surface conditions provide a high percentage of permeability and a longer time of concentration. With the construction of buildings, parking lots, etc., permeability and the time of concentration are significantly decreased. These modifications may create harmful effects on properties downstream.

Criteria for differential runoff and detention guidelines are set out in the following paragraphs, in an attempt to mitigate the possible effects of development on downstream properties due to increased runoff.

5.2 VOLUME OF DETENTION

Volumes of detention shall be evaluated according to the following methods:

- A. Volume of detention for basins with total drainage areas of less than 100 acres may be evaluated by the "Modified Rational Hydrograph Method."
- B. For basins with total drainage areas larger than 100 acres, the Owner's Engineer shall submit the proposed method of evaluation for the sizing of the retention basin or detention basin to the City Staff. The City Staff will evaluate the method for professional acceptance, applicability, and reliability. No detailed review for projects larger than 100 acres will be rendered before the method of evaluation of the retention or detention basin is approved. See examples of approved computer hydrologic analysis methods for designing detention basins for drainage areas greater than 100 acres in size (at the end of this section).
- C. Maintenance of the detention pond at calculated storage volume, plus required freeboard, shall be the responsibility of the developer in perpetuity; except in the case of a subdivision, where the property owners' association shall bear such responsibility.

5.3 DESIGN CRITERIA

Stormwater detention ponds shall be designed to limit the peak stormwater discharge rate of the 2-, 10-, 25-, 50-, and 100-year storm frequencies after development to predevelopment rates.

Figure 5.1 illustrates the concept of detention storage by comparing a runoff hydrograph to a detention facility outflow hydrograph.

A concrete trickle channel with a minimum width of 4 feet and a minimum slope of 0.40% may be required for detention ponds at the discretion of the City.

5.4 METHOD OF DETENTION

The following conditions and limitations shall be observed in selection and use of the method of detention:

5.4.1 GENERAL LOCATION

Detention facilities shall be located within the parcel limits of the project under consideration. No detention or ponding will be permitted within public road rights-of-ways. Location of detention facilities immediately upstream or downstream of the project will be considered by special request if proper documentation is submitted with reference to practicality, feasibility, and proof of ownership or right-of-use of the area proposed. Conditions for general location of detention facilities are identified in the following sections.

5.4.2 DRY RESERVOIRS

Wet weather ponds or dry reservoirs shall be designed with proper safety, stability, and ease of maintenance facilities. Maximum side slopes for grass reservoirs shall not exceed 1' vertical for 3' horizontal (3:1) unless adequate measures are included to provide for the above-noted features. In no case shall the limits of maximum ponding elevation be closer than 20' horizontally from any building or less than 2' vertically below the lowest sill or floor elevation. The entire reservoir area (the bottom and interior slopes to the top of the bank) shall be sodded prior to final plat approval or issuance of certificate of occupancy. Any area designed as an overflow relief, or any area susceptible to overflow by higher than design intensity rainfall shall be sodded or paved depending upon the outflow velocity.

5.4.3 PERMANENT LAKES

Permanent lakes with fluctuating levels may be used as detention areas provided that the limits of maximum ponding elevations are no closer than 50' horizontal from any building and greater than 2' below the lowest sill or floor elevation of any building.

Maximum side slopes for the fluctuating area of permanent lakes shall be 1' vertical to 3' horizontal (3:1) unless provisions are included for safety, stability, and ease of maintenance.

Special consideration is suggested regarding safety and accessibility of small children in design of permanent lakes in residential areas. Allowance for siltation during construction, for a period of no less than 1 year, is also recommended.

The entire area between the normal pool and the top of the pond bank shall be sodded. Also, calculations must be provided to ensure adequate storage is provided for the 100-year storm above the normal pool elevation. Any area designed as an overflow relief, or any area susceptible to overflow by higher than design intensity rainfall shall be sodded or paved depending upon the outflow velocity. An analysis shall be furnished of any soil proposed for use in construction of an earthen dam. The City may request borings of the foundation for the earthen dam. A Professional Engineer shall design all earthen dam structures.

5.4.4 PARKING LOTS

Detention is permitted in parking lots to maximum depths of 6". In no case should the maximum limits of ponding be closer than 10' to a building unless waterproofing of the building and pedestrian accessibility are properly documented and approved.

The minimum freeboard and the maximum ponding elevation to the lowest sill or floor elevation shall be 2'.

5.4.5 OTHER METHODS

Other methods of detention such as seepage pits, French drains, etc., are discouraged. If other methods are proposed, proper documentation of soil data, percolation, geological features, etc., will be needed for review and consideration.

5.4.6 VERIFICATION OF ADEQUACY

Upon completion of a project, the Engineer of Record shall provide record drawings to the City, detailing the constructed condition, and shall certify that the project was constructed in accordance with the plans and specifications. The certification shall document that the constructed project is adequate and sufficient to accomplish the purpose of the project.

5.4.7 OUTLET WORKS

Detention facilities shall be provided with effective outlet works. Safety considerations shall be an integral part of the design of all outlet works. Plan view and sections of the structure with adequate details shall be included in Plans.

The structure selected shall have documented evidence that it will control the 2-, 10-, 25-, 50-, and 100-year storms.

The overflow opening or spillway shall be designed to accept the total peak runoff of the improved tributary area.

Figures 5.2 through 5.4 illustrate schematics and configurations. Figures 5.7 through 5.10 illustrate design equations for orifice, V-notch weir, rectangular weir, and multistage release outlet structure.

5.4.8 DISCHARGE SYSTEMS

The drainage system below the detention pond outlet structure shall be sized for the total post-developed peak runoff flowing to the structure, including all flows from the detention pond and any other onsite or offsite sources.

5.4.9 OWNERSHIP OF STORMWATER DETENTION PONDS

Ownership of stormwater detention ponds in residential subdivisions accepted by the City shall be vested in a property owners' association funded by the owners of all lots within the subdivision prior to filing of the final plat. The Developer must warrant the operation of the drainage system for a 1-year period after the acceptance by the property owners' association by an acceptable Maintenance Bond or equal provided by the Developer's Contractor or the Developer. The bond shall be required to be extended until 1 year after all phases of the subdivision that substantially

drain into the basin are completed. Maintenance of the pond shall be the perpetual responsibility of the property owners' association.

Ownership and maintenance of stormwater detention ponds in commercial, industrial, and non-residential areas shall not be accepted by the City of Tontitown, and shall be vested in the property owner.

No alteration of the drainage system will be allowed without the approval of the City. If construction of the basin is not complete, a cash bond from an acceptable financial institution shall be posted in addition to the Performance/Payment Bond.

5.4.10 EASEMENTS

Easements shall be provided by the appropriate legal document, and shall be shown on the plans for all detention facilities.

A minimum 20'-wide drainage easement shall be provided around the 100-year flood pool, connecting the tributary pipes and the discharge system along the most passable routing of piping system.

5.4.11 MAINTENANCE

Detention facilities, when required, are to be built in conjunction with storm sewer installation and/or grading. Since these facilities are intended to control increased runoff, they must be partially or fully operational soon after the clearing of the vegetation. Silt and debris connected with early construction shall be removed periodically from the detention area and control structure to maintain the facility's storage capacity.

Maintenance of detention facilities is divided into two components. The first is long-term maintenance that involves removal of sediment from the basin and outlet control structure. Maintenance to an outlet structure is minimum due to the initial design of permanent concrete or pipe structures. Studies indicate that in developing areas, basin cleaning by front-end loader or grader is estimated to be needed once every 5 to 10 years. The developer, property owners' association, and all non-residential property Owners are responsible for long-term maintenance in detention basins. The City shall not be responsible for maintenance of detention facilities.

Short-term maintenance or annual maintenance is the second component and is the responsibility of the Developer or association for 1 year after acceptance of the final plat or filing of the last subdivision phase that

substantially adds stormwater to a detention basin. The items considered short-term maintenance are as follows:

1. Minor dirt and mud removal
2. Outlet cleaning
3. Mowing
4. Herbicide spraying (in strict conformance with state and federal law)
5. Litter control

The responsibility of maintenance of the detention facilities and single-lot development projects shall remain with the general contractor until final inspection of the development is performed and approved, and a legal occupancy permit is issued. After legal occupancy of the project, the maintenance of detention facilities shall be vested with the owner of the detention pond.

5.5 DETENTION BASIN DESIGN PROCEDURE (Using the Modified Rational Method)

1. Compute existing (predevelopment) and proposed (developed) site characteristics:
 - A. Drainage Area
 - B. Composite Runoff Coefficient
 - C. Time of Concentration (use Figures 2.1 and/or 2.2)
2. Determine rainfall intensity for existing conditions (2- through 100-year storm) from the Rainfall Intensity-Duration (Table 2.2).
3. Compute existing peak runoff rates using Rational Formula $Q=CiA$ - these will also be the maximum allowable release rates from the detention basin.
4. Determine inflow hydrograph using Modified Rational Method (see Figure 5.6 and Procedure).
5. Find estimated detention volume using Modified Rational Method.

6. Size detention basin based on estimated required volume. Develop stage-storage curve for the detention basin.
7. Size release structure based on allowable release flow. Develop stage-discharge curve for the release structure.
8. Route the inflow hydrographs (developed using Modified Rational Method for the 2- through 100-year storms) through the detention basin using Modified Puls Method. (See Exhibit 5-2).
9. Check routed hydrographs to ensure flows do not exceed predevelopment peaks. Adjust detention basin and release structure, if necessary.

5.6 STORMWATER DETENTION ANALYSIS SOFTWARE

The City will allow the use of the following software or an acceptable equal approved by the City for the analysis of stormwater detention facilities.

5.6.1 POND-2

Pond-2 is a program for detention pond design. It estimates detention storage requirements, computes a volume-rating table for any pond configuration, routes hydrographs for different return frequencies through alternative ponds, and plots the resulting inflow and outflow hydrographs.

Pond-2 automatically computes outflow-rating curves for single or multi-stage outlet structures, and computes the controlling flow rate for outlets operating in series. Pond-2 handles orifices, weirs, box culverts, circular culverts, and more. Pond-2 is included in the **Pond Pack**, by Haested Methods, where it is integrated with Quick TR-55.

5.6.2 HEC-HMS

HEC-HMS generates hydrographs from rainfall or snowmelt, adds or diverts them, then routes through reaches and reservoirs. HEC-HMS models multiple streams and reservoir networks, and has dam failure simulation capabilities. It handles level-pool routing for reservoirs and detention ponds, and routes through stream reaches using Kinematic Wave, Muskingum, Muskingum-Cunge, Modified Puls, and other methods. HEC-1 supports five methods for computing infiltration and abstraction losses, and computes unit hydrographs using the Clark methods, Snyder method, and SCS dimensionless hydrographs.

EXHIBIT 5-1

**MODIFIED RATIONAL METHOD DETENTION
BASIN DESIGN MANUAL PROCEDURE**

EXHIBIT 5-1
MODIFIED RATIONAL METHOD DETENTION BASIN DESIGN
MANUAL PROCEDURE

Given: A 10-acre site currently agricultural use is to be developed for townhouses. The entire area is the drainage area of the proposed detention basin.

Determine: Maximum release rate and required detention storage.

Solution: Step 1:

Determine 100-year peak runoff rate prior to site development. This is the maximum release rate from site after development.

Present Conditions $Q = CiA$

$$C = .30$$

$$T_c = 20 \text{ min.}$$

$$i_{100} = 7.0 \text{ in./hr.}$$

$$Q_{100} = .30 (7.0) 10 = 21.0 \text{ cfs (Maximum release rate)}$$

Step 2:

Determine inflow hydrograph for storms of various durations in order to determine maximum volume required with release rate determined in Step 1.

NOTE: Incrementally increase durations by 10 minutes to determine maximum required volume. The duration with a peak inflow less than the maximum release rate or where required storage is less than storage for the prior duration is the last increment.

Future Conditions (Townhouses)

$$C = .80$$

$$T_c = 15 \text{ min.}$$

$$i_{100} = 7.0 \text{ in./hr.}$$

$$Q_{100} = .80 (7.0) 10 = 56.0 \text{ cfs}$$

Check various duration storms

$$20 \text{ min. } i = 7.0 \quad Q = .80 (7.0) 10 = 56.0 \text{ cfs}$$

$$30 \text{ min. } i = 5.8 \quad Q = .80 (5.8) 10 = 46.4 \text{ cfs}$$

$$40 \text{ min. } i = 5.0 \quad Q = .80 (5.0) 10 = 40.0 \text{ cfs}$$

$$50 \text{ min. } i = 4.4 \quad Q = .80 (4.4) 10 = 35.2 \text{ cfs}$$

$$60 \text{ min. } i = 4.0 \quad Q = .80 (4.0) 10 = 32.0 \text{ cfs}$$

70 min. $i = 3.7$ $Q = .80 (3.7) 10 = 29.6$ cfs
 80 min. $i = 3.4$ $Q = .80 (3.4) 10 = 27.2$ cfs
 90 min. $i = 3.1$ $Q = .80 (3.1) 10 = 24.8$ cfs

NOTE: Rainfall intensities are for illustrative purposes only and do not represent actual values for the City of Tontitown.

Maximum Storage Volume is determined by deducting the volume of runoff released during the time of inflow from the total outflow for each storm duration. See Figure 5.1.

$$V = \text{time} \times Q_{in} \times 60 \text{ sec/min} - 0.5 \times Q_{out} \times (\text{Time} + T_c) \times 60 \text{ sec/min.}$$

15 min. Storm Inflow	15 (61.6) 60 sec/min =	55,440 cf
Outflow (0.5) 30 (21.0) 60 sec/min =		<u>18,900 cf</u>
	Storage	36,540 cf
20 min. Storm Inflow	20 (56.0) 60 sec/min =	67,200 cf
Outflow (0.5) 35 (21.0) 60 sec/min =		<u>22,050 cf</u>
	Storage	45,150 cf
30 min. Storm Inflow	30 (46.4) 60 sec/min =	83,520 cf
Outflow (0.5) 45 (21.0) 60 sec/min =		<u>28,350 cf</u>
	Storage	55,170 cf
40 min. Storm Inflow	40 (40.0) 60 sec/min =	96,000 cf
Outflow (0.5) 55 (21.0) 60 sec/min =		<u>34,650 cf</u>
	Storage	61,350 cf
50 min. Storm Inflow	50 (35.2) 60 sec/min =	105,600 cf
Outflow (0.5) 65 (21.0) 60 sec/min =		<u>40,950 cf</u>
	Storage	64,650 cf
60 min. Storm Inflow	60 (32.0) 60 sec/min =	115,200 cf
Outflow (0.5) 75 (21.0) 60 sec/min =		<u>47,250 cf</u>
	Storage	67,950 cf
70 min. Storm Inflow	70 (29.6) 60 sec/min =	124,320 cf
Outflow (0.5) 85 (21.0) 60 sec/min =		<u>53,550 cf</u>
	Storage	70,770 cf

80 min. Storm Inflow 80 (27.2) 60 sec/min =	130,560 cf
Outflow (0.5) 95 (21.0) 60 sec/min =	<u>59,850 cf</u>
Storage	70,710 cf

90 min. Storm Inflow 90 (24.8) 60 sec/min =	133,920 cf
Outflow (0.5) 105 (21.0) 60 sec/min =	<u>66,150 cf</u>
Storage	67,770 cf

Step 3:

Route design storm hydrograph through the detention basin using the Modified Puls Routing Method or another approved method, based on final detention basin and release structure design. Computer programs to accomplish this task are readily available.

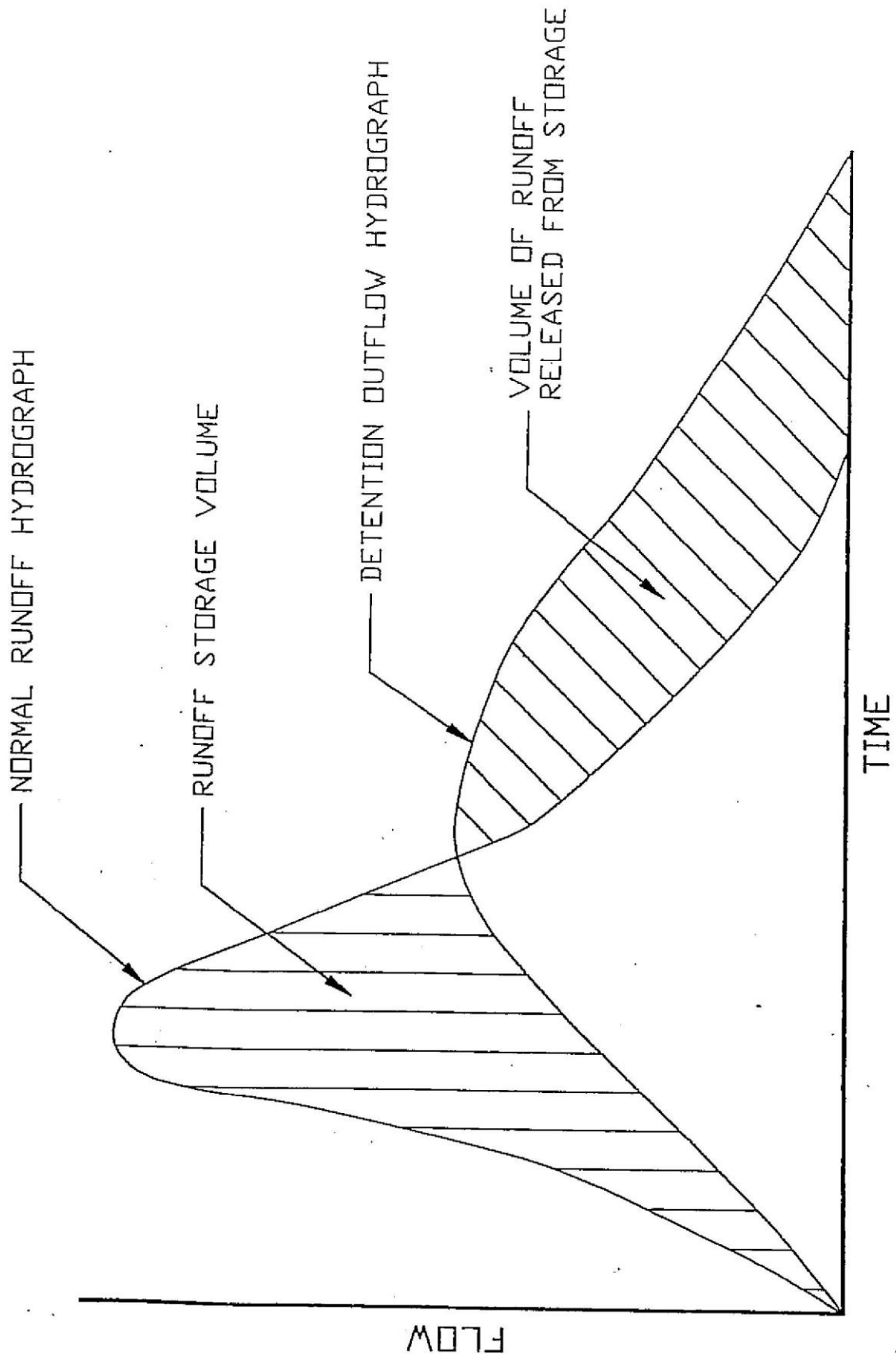

CONCEPT OF DETENTION

SOURCE:
City of
SPRINGDALE
Arkansas

CONCEPT OF DETENTION POND

Figure 5.1

EXAMPLES OF OUTLET STRUCTURES

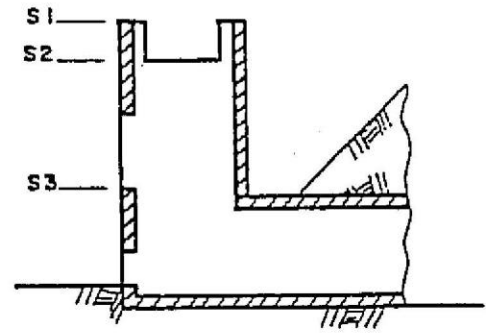
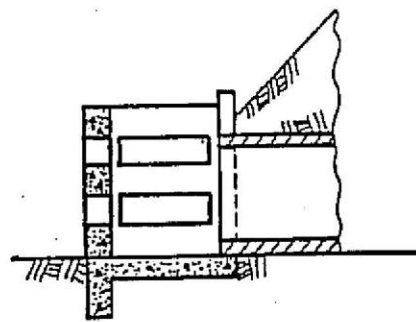
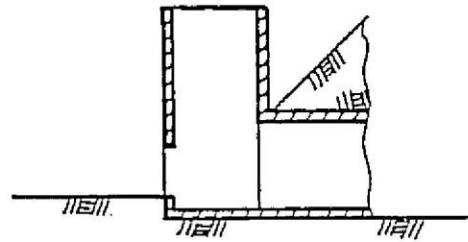
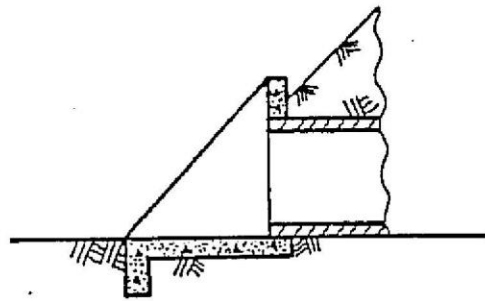
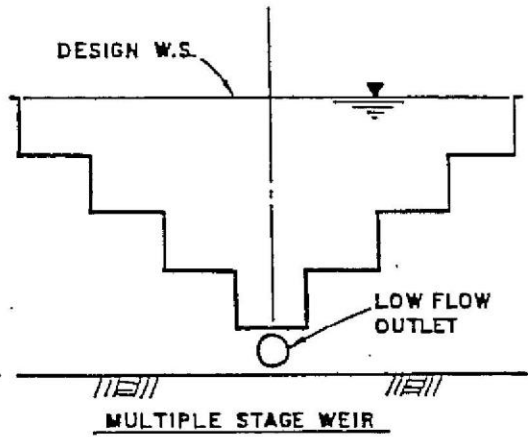
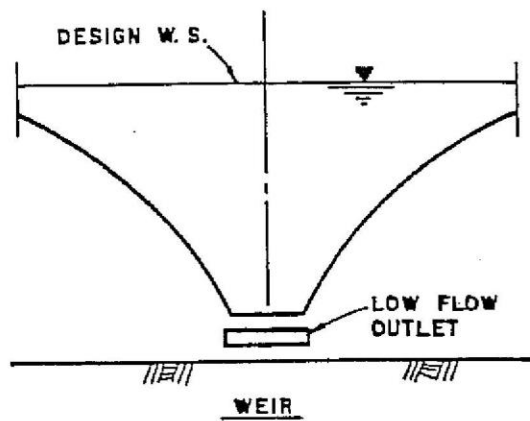

SOURCE: CITY OF TULSA, STORMWATER
MANAGEMENT CRITERIA MANUAL

ORIFICE PLATE DETAILS

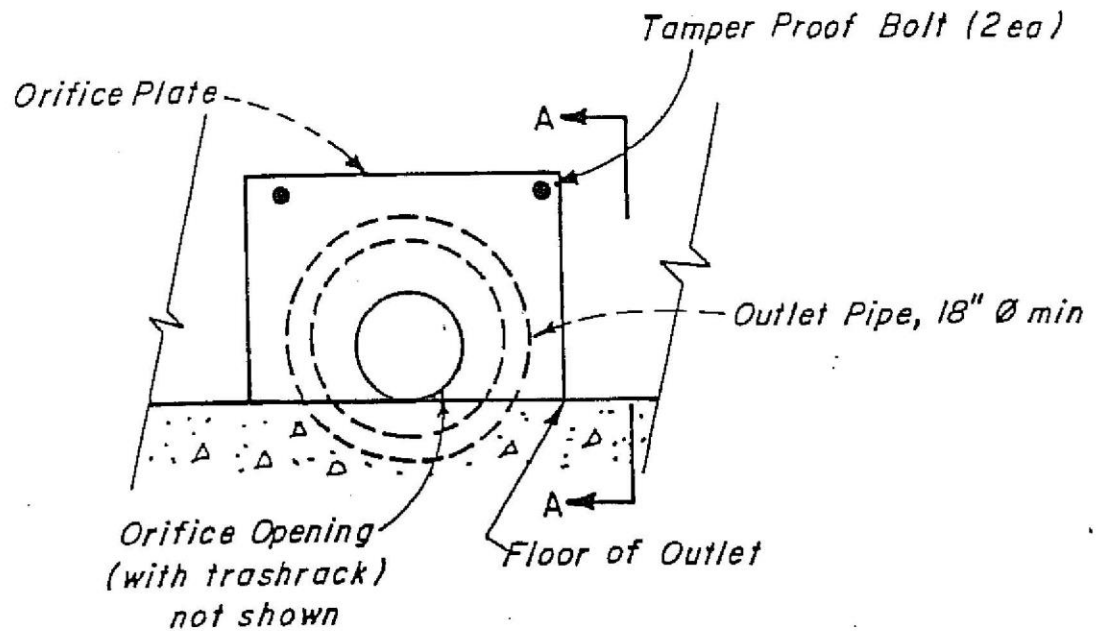

NOTE: Trashrack clear area to be 10 times orifice opening area.

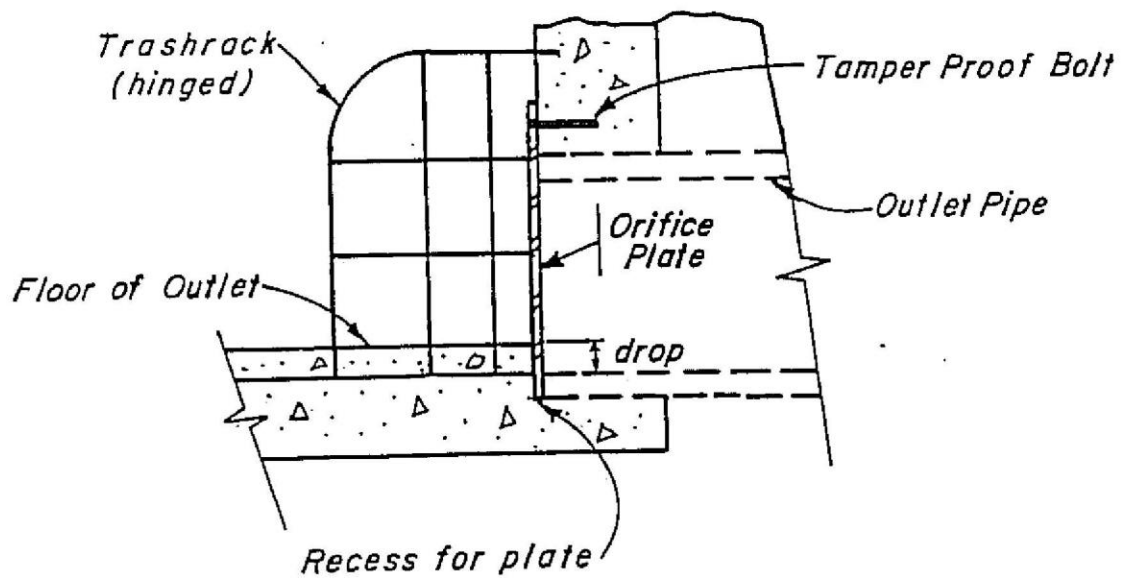

SOURCE: CITY OF TULSA, STORMWATER
MANAGEMENT CRITERIA MANUAL

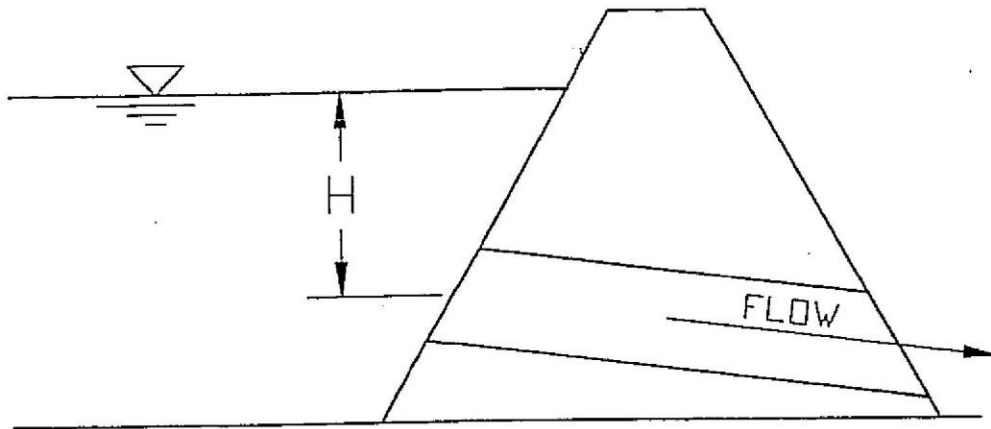

Orifice Flow Equation

$$Q = CA(2gH)^{1/2}$$

where

Q = Orifice discharge in CFS

C = Orifice Coefficient

A = Area of orifice in square feet

g = Gravitational constant (32.2 FT/S²)

H = Head on the orifice measured from the centerline in feet

ORIFICE DESIGN

Add A
TABLE Orifice ~~Coefficients~~ Coefficients

SOURCE:
City of
SPRINGDALE
Arkansas

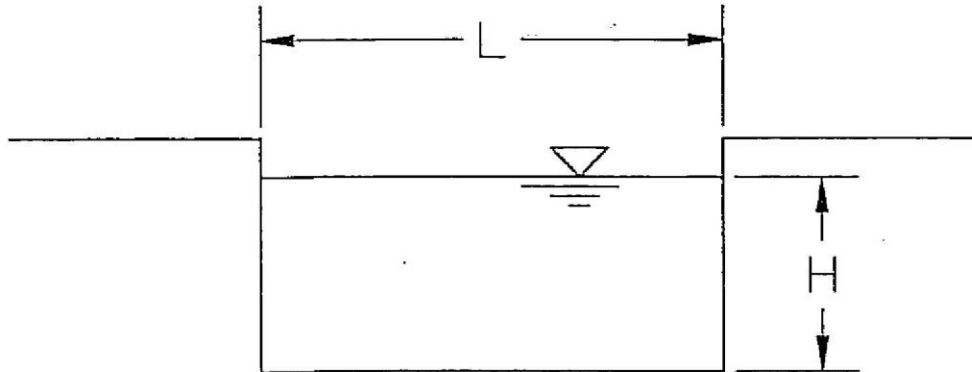

Rectangular Weir Flow Equation

$$Q = CLH^{3/2}$$

where

Q = Weir discharge in CFS

C = Weir coefficient

L = Horizontal length of the weir on feet

H = Head on the weir in feet

RECTANGULAR WEIR

TABLE OF CONTENTS - SECTION 6

SECTION 6 - FLOW IN STREETS

- 6.1 General
 - 6.1.1 Interference Due to Flow in Streets
 - 6.1.2 Interference Due to Ponding
 - 6.1.3 Interference Due to Water Flowing Across Traffic Lane
 - 6.1.4 Effect on Pedestrians
 - 6.1.5 Street Cross Flow
 - 6.1.6 Allowable Flow of Water Through Intersections
- 6.2 Permissible Spread of Water
 - 6.2.1 Principal and Minor Arterial Streets
 - 6.2.2 Collector Streets
 - 6.2.3 Residential Streets
- 6.3 Bypass Flow
- 6.4 Minimum and Maximum Velocities
- 6.5 Design Method
 - 6.5.1 Straight Crowns

SECTION VI - FLOW IN STREETS

6.1 GENERAL

The location of inlets and permissible flow of water in the streets should be related to the extent and frequency of interference to traffic and the likelihood of flood damage to surrounding property. Interference to traffic is regulated by design limits on the spread of water into traffic lanes, especially in regard to arterials. Flooding of surrounding property from streets is controlled by limiting depth of runoff in the street to the top of the curb for the design storm.

6.1.1 INTERFERENCE DUE TO FLOW IN STREETS

Water that flows in a street, whether from rainfall directly onto the pavement surface or overland flow entering from adjacent land areas, will flow in the gutters of the street until it reaches an overflow point or some other outlet, such as a storm sewer inlet. As the flow progresses downhill and additional areas contribute to the runoff, the width of flow will increase and progressively encroach into a traffic lane. On streets where parking is not permitted, as with many arterial streets, flow widths exceeding a few feet become a traffic hazard. Field observations show that vehicles will crowd adjacent lanes to avoid curb flow.

As the width of flow increases further, it becomes impossible for vehicles to operate without moving through water, and they must use the now-inundated lane. Splash from vehicles traveling in the inundated lane obscures the vision of drivers of vehicles moving at a high rate of speed in the open lane. Eventually, if width and depth of flow become great enough, the street loses its effectiveness as a traffic-carrier. During these periods, it is imperative that emergency vehicles such as fire trucks, ambulances, and police cars be able to traverse the streets by moving along the crown of the roadway.

6.1.2 INTERFERENCE DUE TO PONDING

Storm runoff, ponded on the street surface because of grade changes or the crown slope of intersecting streets, has a substantial effect on the street's traffic carrying capacity. Because of the localized nature of ponding, vehicles moving at a relatively high speed may enter a pond. The manner in which ponded water affects traffic is essentially the same as for curb flow, that is, the width of spread into the traffic lane is critical. Ponded water will often completely halt all traffic. Ponding in streets has the added hazard of surprise to drivers of moving vehicles, often producing erratic and dangerous responses.

6.1.3 INTERFERENCE DUE TO WATER FLOWING ACROSS TRAFFIC LANE

Whenever stormwater runoff, other than limited sheet flow, moves across the traffic lane, a serious and dangerous impediment to traffic flow occurs. The cross-flow may be caused by super-elevation of the curb, a street intersection, and overflow from the higher gutter on a street with cross fall, or simply poor street design. The problem associated with this type of

flow is the same as for ponding in that it is localized in nature. Vehicles may be traveling at high speed when they reach the location. If vehicular movement is slow and the street is lightly traveled, as on residential streets, limited cross flows should not cause sufficient interference to be unacceptable.

The depth and velocity of cross flows shall be maintained within such limits that they do not have sufficient force to threaten moving traffic.

6.1.4 EFFECT ON PEDESTRIANS

In areas with heavily used sidewalks, splash due to vehicles moving through water adjacent to the curb is a serious problem.

Streets should be classified with respect to pedestrian traffic as well as vehicular traffic. As an example, local streets adjacent to a school may serve as arterials for pedestrian traffic. The allowable width of gutter flow and extent of ponding should reflect this fact.

6.1.5 STREET CROSS FLOW

Whenever storm runoff, other than limited sheet flow, moves across a traffic lane, a serious and dangerous impediment to traffic flow occurs, therefore, cross flow is not allowed. In case of superelevation of a curve or overflow from the higher gutter on a street with cross fall, potential cross flow is to be collected by inlets prior to the superelevation transition.

6.1.6 ALLOWABLE FLOW OF WATER THROUGH INTERSECTIONS

As the stormwater flow approaches an arterial street or tee intersection, an inlet is required. Concrete swales may be used to convey water across local streets at the intersection of a local street and a larger capacity street. Swales are not allowed across larger capacity streets without the approval of the City.

6.2. PERMISSIBLE SPREAD OF WATER

- A. The depth of flow in the street and the allowable spread of water in the gutter and street shall be limited as defined below:

6.2.1 ARTERIAL AND MAJOR COLLECTOR STREETS

Inlets shall be spaced at low points and such an interval to provide one clear traffic lane twelve feet wide in each direction during the peak flows of the design storm.

Four and five lane streets shall be designed so that a minimum of one traffic lane is provided in each direction during the peak flows of the design storm.

Use of inlets with a gutter depression greater than the standard depression (4") is discouraged adjacent to the traffic lane. If depressed inlets are used, they shall be recessed back from the gutter line a minimum of one foot and a maximum of two feet. All recessed inlets are subject to approval of the City Staff. The design storm will have a 25-year return frequency.

Example:

Street width = 50' back-to-back; two 12' lanes to remain clear.

Therefore: Street flow in each gutter shall not exceed $(50 - 24)/2 = 13'$.

6.2.2 MINOR COLLECTOR STREETS

The flow of water in gutters of a collector street shall be limited so that one standard lane, twelve feet wide, will remain clear during the peak runoff from the design storm. Inlets shall be located at low points or wherever the flow exceeds the one-standard-lane requirement.

Use of inlets with a gutter depression greater than the standard depression (4") is discouraged adjacent to the traffic lane. If depressed inlets are used, they shall be recessed back from the gutter line a minimum of one foot and a maximum of two feet. All recessed inlets are subject to approval of the City Staff. The design storm will have a 10-year return frequency.

Example: Street width = 38' back-to-back; one 12' traffic lane to remain clear.

Therefore: Street flow in each gutter shall not exceed $(38' - 12')/2 = 12'$

6.2.3 LOCAL STREETS

The flow of water in gutters of a local street shall be limited to a depth of flow at the curb of 6" or wherever the street is just covered, whichever is the least depth. Inlets shall be located at low points or wherever the gutter flow exceeds the permissible spread of water.

Use of inlets with a gutter depression greater than the standard depression (4") is discouraged adjacent to the traffic lane. If depressed inlets are used, they shall be recessed back from the gutter line a minimum of one foot and a maximum of two feet. All recessed inlets are subject to approval of the City Staff. The design storm will have a 10-year return frequency.

- B. The allowable spread of water for all street classifications as defined in (A) above applies to all configurations and layouts including the case of streets built on hillsides parallel to the contours. The maximum allowable spread of depth of water as defined in (A) above applies even if the downhill lane is theoretically clear.
- C. For storm events in excess of the design storm for each street classification, the 100-year frequency storm shall be determined and the depth of flow resulting from the 100-year storm shall be determined and plotted on the construction drawings. The street, sidewalk, and driveway cuts shall be designed such that all storms greater than the design storm do not convey through driveway cuts and across private property but remains generally within the street right-of-way and/or drainage easements.

6.3 BYPASS FLOW

Flow bypassing each inlet must be included in the total gutter flow to the next inlet downstream. A bypass of 10 to 20 percent per inlet will result in a more economical drainage system. Refer to Section VII for inlet design.

6.4 MINIMUM AND MAXIMUM VELOCITIES

To ensure cleaning velocities at very low flows, the gutter shall have a minimum slope of 0.005 feet per foot (0.5 percent). The maximum velocity of curb flow shall be 10 fps. Along sharp horizontal curves, peak flows tend to jump behind the curb line at driveways and other curb breaks. Water running behind the curb line can result in considerable damage due to erosion and flooding. In a gutter where the slope is greater than 0.10 feet per foot (10 percent) and the radius is 400' or less, design depth of flow shall not exceed 4" at the curb.

6.5 DESIGN METHOD

6.5.1 STRAIGHT CROWNS

Flow in gutters that are straight crown pavements is normally calculated by using Manning's Equation for various hydraulic properties for uniform flow in pavement gutters and triangular channels. The equation is:

$$Q_o = \frac{0.56 z S_o^{1/2} Y_o^{8/3}}{n}$$

Q_o = Gutter discharge (CFS)

z = Reciprocal of the crown slope (ft/ft) (feet per foot)

S_o = Street or gutter slope (ft/ft)

n = Roughness coefficient

Y_o = Depth of flow in gutter (ft)

The nomograph in Figure 6.1 or Figure 6.2 provides for direct solution of flood conditions for triangular channels most frequently encountered in urban street drainage design. For a standard concrete gutter, a value of 0.013 for "n" is recommended.

Figures 6.3 and 6.4 may be used to compute gutter velocities and frontal flow to total gutter flow.

Figure 6.5 provides a summary of street flow for triangular curb sections for different street slopes.

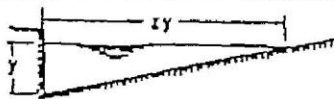

EQUATION: $Q = 0.56 \left(\frac{z}{n}\right) s^{1/2} y^{5/2}$

Z=RECIPROCAL OF TRANSVERSE SLOPE

n=COEFFICIENT OF ROUGHNESS IN MANNING'S FORMULA

s=GRADE OF CHANNEL IN FT./FT.

y=DEPTH AT CURB OR DEEPEST POINT IN FT.

EXAMPLE (See dashed lines)

GIVEN: $s=0.03$

$Z=24$

$n=0.02$

$Q=2.0$ CFS

$Z/n=1200$

FIND: $y=0.22$

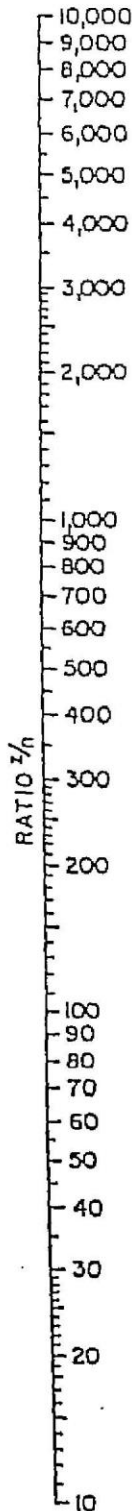

TURNING LINE

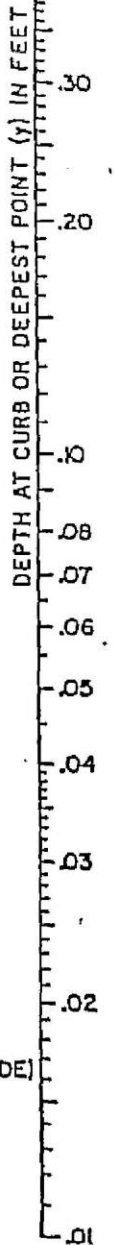
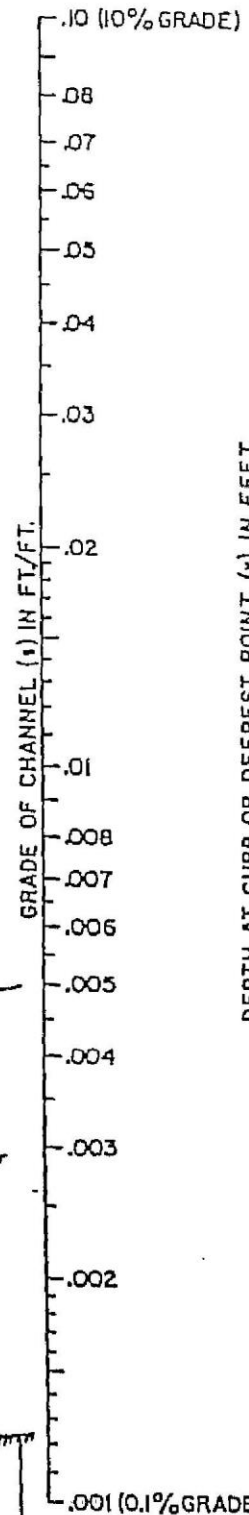
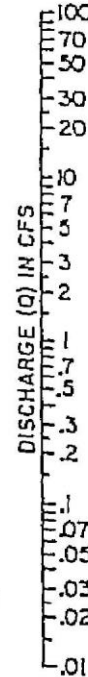

INSTRUCTIONS

1. CONNECT $\frac{z}{n}$ RATIO WITH SLOPE (s) AND CONNECT DISCHARGE (Q) WITH DEPTH (y). THESE TWO LINES MUST INTERSECT AT TURNING LINE FOR COMPLETE SOLUTION.

2. FOR SHALLOW V-SHAPED CHANNEL AS SHOWN USE NOMOGRAPH TO DETERMINE DISCHARGE IN SECTIONS a AND b SEPERATELY. THEN $Q_T = Q_a + Q_b$.



3. TO DETERMINE DISCHARGE Q_x IN PORTION OF CHANNEL HAVING WIDTH x: DETERMINE DEPTH y FOR TOTAL DISCHARGE IN ENTIRE SECTION a. THEN USE NOMOGRAPH TO DETERMINE Q_b IN SECTION b FOR DEPTH $y' = y - (\frac{x}{z})$.

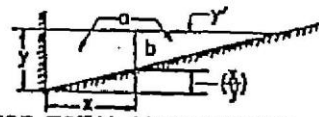

4. TO DETERMINE DISCHARGE IN COMPOSITE SECTION: FOLLOW INSTRUCTION 3. TO OBTAIN DISCHARGE IN SECTION a AT ASSUMED DEPTH y; OBTAIN Q_b FOR SLOPE RATIO Z_b AND DEPTH y' . THEN $Q_T = Q_a + Q_b$.

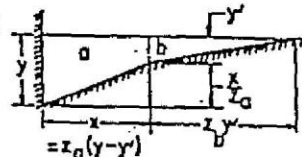

NOMOGRAPH FOR FLOW IN TRIANGULAR CHANNELS

S

$$V = \frac{1.48}{n} S^{0.5} S_x^{0.67} T^{0.67}$$

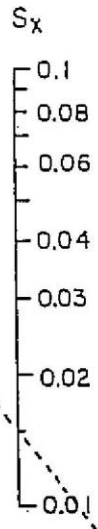
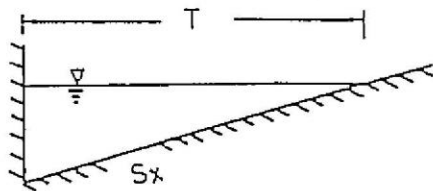
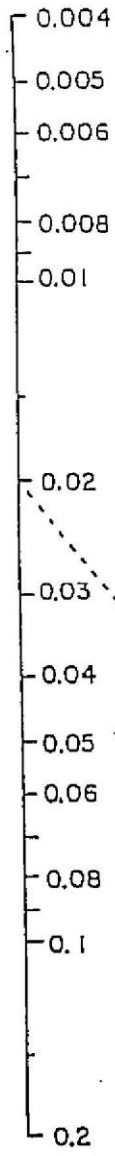

TURNING LINE

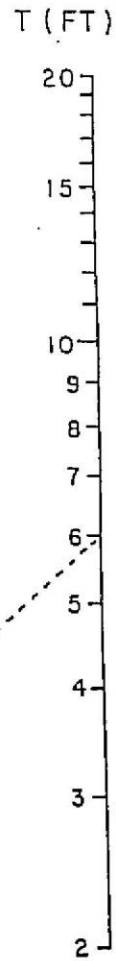
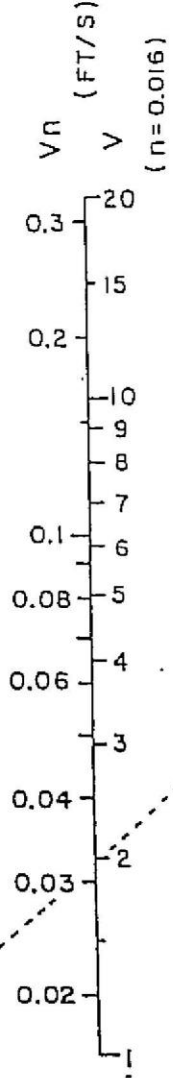

EXAMPLE

GIVEN

- S = 0.02
- S_x = 0.015
- T = 6 FT
- n = 0.016

FIND

- Vn = 0.32 FT/S
- V = 1.95 FT/S

SOURCE:
City of
SPRINGDALE
Arkansas

VELOCITY IN TRIANGULAR GUTTER SECTIONS

Figure 6.3

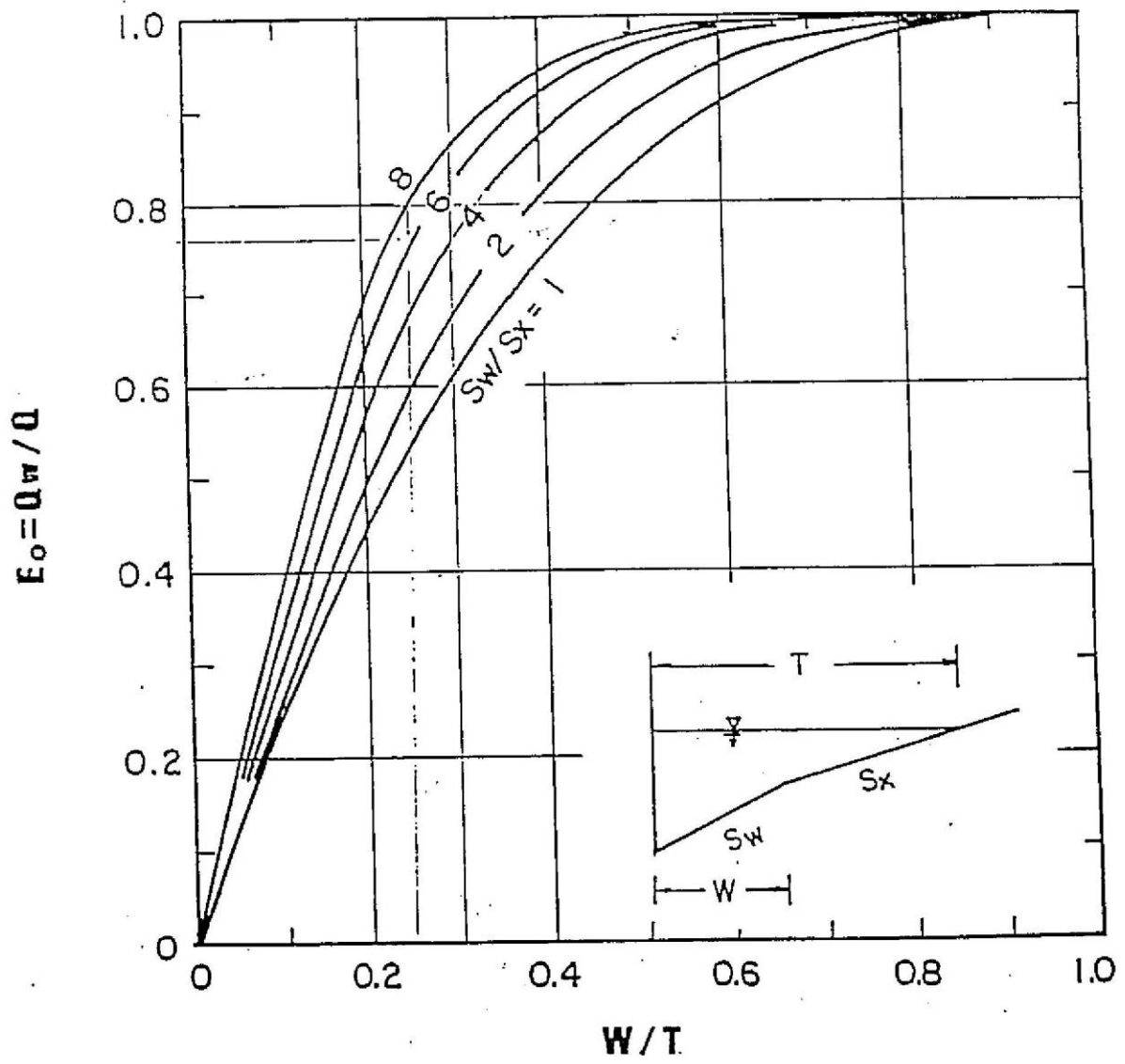

SOURCE:
City of
SPRINGDALE
Arkansas

RATIO OF FRONTAL FLOW TO TOTAL GUTTER FLOW

Figure 6.4

FLOW IN TRIANGLE CURB SECTIONS
AT
DIFFERENT STREET SLOPES

TOTAL FLOW Qc (CFS)	n	RDVY SLOPE S (X) SK (X)	CROSS SLOPE SK (X)	PONDED WIDTH T (FT)	DEPTH AT CURB d (FT)	VEL V (FPS)	TOTAL FLOW Qc (CFS)	n	RDVY SLOPE S (X) SK (X)	CROSS SLOPE SK (X)	PONDED WIDTH T (FT)	DEPTH AT CURB d (FT)	VEL V (FPS)
< 0.50% Street Slope >													
1.0	0.015	0.50X	3.33X	5.8	0.19	1.78	1.0	0.015	3.00X	3.33X	4.2	0.14	3.48
2.0	0.015	0.50X	3.33X	7.5	0.25	2.12	2.0	0.015	3.00X	3.33X	5.4	0.18	4.14
3.0	0.015	0.50X	3.33X	8.8	0.29	2.34	3.0	0.015	3.00X	3.33X	6.3	0.21	4.58
4.0	0.015	0.50X	3.33X	9.8	0.33	2.52	4.0	0.015	3.00X	3.33X	7.0	0.23	4.92
5.0	0.015	0.50X	3.33X	10.6	0.35	2.66	5.0	0.015	3.00X	3.33X	7.6	0.25	5.21
6.0	0.015	0.50X	3.33X	11.4	0.38	2.79	10.0	0.015	3.00X	3.33X	9.8	0.33	6.20
7.0	0.015	0.50X	3.33X	12.0	0.40	2.90	15.0	0.015	3.00X	3.33X	11.5	0.38	6.86
8.0	0.015	0.50X	3.33X	12.7	0.42	3.00	20.0	0.015	3.00X	3.33X	12.8	0.42	7.38
9.0	0.015	0.50X	3.33X	13.2	0.44	3.09	25.0	0.015	3.00X	3.33X	13.9	0.46	7.80
10.0	0.015	0.50X	3.33X	13.8	0.46	3.17	30.0	0.015	3.00X	3.33X	14.9	0.49	8.17
12.5	0.015	0.50X	3.33X	15.0	0.50	3.35	31.0	0.015	3.00X	3.33X	15.0	0.50	8.23
< 1.00% Street Slope >													
1.0	0.015	1.00X	3.33X	5.1	0.17	2.30	1.0	0.015	4.00X	3.33X	3.9	0.13	3.87
2.0	0.015	1.00X	3.33X	6.6	0.22	2.74	2.0	0.015	4.00X	3.33X	5.1	0.17	4.61
3.0	0.015	1.00X	3.33X	7.7	0.26	3.04	3.0	0.015	4.00X	3.33X	5.9	0.20	5.10
4.0	0.015	1.00X	3.33X	8.6	0.29	3.26	4.0	0.015	4.00X	3.33X	6.6	0.22	5.48
5.0	0.015	1.00X	3.33X	9.3	0.31	3.45	5.0	0.015	4.00X	3.33X	7.2	0.24	5.80
6.0	0.015	1.00X	3.33X	10.0	0.33	3.61	10.0	0.015	4.00X	3.33X	9.3	0.31	6.90
7.0	0.015	1.00X	3.33X	10.6	0.35	3.76	15.0	0.015	4.00X	3.33X	10.9	0.36	7.64
8.0	0.015	1.00X	3.33X	11.1	0.37	3.88	20.0	0.015	4.00X	3.33X	12.1	0.40	8.23
9.0	0.015	1.00X	3.33X	11.6	0.39	4.00	25.0	0.015	4.00X	3.33X	13.1	0.44	8.69
10.0	0.015	1.00X	3.33X	12.1	0.40	4.11	30.0	0.015	4.00X	3.33X	14.1	0.47	9.09
17.9	0.015	1.00X	3.33X	15.0	0.50	4.75	35.5	0.015	4.00X	3.33X	15.0	0.50	9.49
< 2.00% Street Slope >													
1.0	0.015	2.00X	3.33X	4.5	0.15	2.99	1.0	0.015	5.00X	3.33X	3.8	0.13	4.21
2.0	0.015	2.00X	3.33X	5.8	0.19	3.56	2.0	0.015	5.00X	3.33X	4.9	0.16	5.01
3.0	0.015	2.00X	3.33X	6.8	0.23	3.94	3.0	0.015	5.00X	3.33X	5.7	0.19	5.55
4.0	0.015	2.00X	3.33X	7.5	0.25	4.23	4.0	0.015	5.00X	3.33X	6.3	0.21	5.96
5.0	0.015	2.00X	3.33X	8.2	0.27	4.47	5.0	0.015	5.00X	3.33X	6.9	0.23	6.31
10.0	0.015	2.00X	3.33X	10.6	0.35	5.32	10.0	0.015	5.00X	3.33X	8.9	0.30	7.50
15.0	0.015	2.00X	3.33X	12.4	0.41	5.90	15.0	0.015	5.00X	3.33X	10.4	0.35	8.31
20.0	0.015	2.00X	3.33X	13.8	0.46	6.34	20.0	0.015	5.00X	3.33X	11.6	0.39	8.93
25.0	0.015	2.00X	3.33X	15.0	0.50	6.70	25.0	0.015	5.00X	3.33X	12.6	0.42	9.45
30.0	0.015	2.00X	3.33X	15.0	0.50	6.70	30.0	0.015	5.00X	3.33X	13.5	0.45	9.89
40.0	0.015	2.00X	3.33X	15.0	0.50	6.70	40.0	0.015	5.00X	3.33X	15.0	0.50	10.63
< 3.00% Street Slope >													
1.0	0.015	3.00X	3.33X	4.2	0.14	3.48	1.0	0.015	6.00X	3.33X	3.7	0.12	4.51
2.0	0.015	3.00X	3.33X	5.4	0.18	4.14	2.0	0.015	6.00X	3.33X	4.7	0.16	5.36
3.0	0.015	3.00X	3.33X	6.3	0.21	4.58	3.0	0.015	6.00X	3.33X	5.5	0.18	5.94
4.0	0.015	3.00X	3.33X	7.0	0.23	4.92	4.0	0.015	6.00X	3.33X	6.1	0.20	6.38
5.0	0.015	3.00X	3.33X	7.6	0.25	5.21	5.0	0.015	6.00X	3.33X	6.7	0.22	6.75
10.0	0.015	3.00X	3.33X	9.8	0.33	6.20	10.0	0.015	6.00X	3.33X	8.6	0.29	8.03
15.0	0.015	3.00X	3.33X	11.5	0.38	6.86	15.0	0.015	6.00X	3.33X	10.1	0.34	8.90
20.0	0.015	3.00X	3.33X	12.8	0.42	7.38	20.0	0.015	6.00X	3.33X	11.2	0.37	9.56
25.0	0.015	3.00X	3.33X	13.9	0.46	7.80	30.0	0.015	6.00X	3.33X	13.0	0.43	10.59
30.0	0.015	3.00X	3.33X	14.9	0.49	8.17	40.0	0.015	6.00X	3.33X	14.5	0.48	11.38
31.0	0.015	3.00X	3.33X	15.0	0.50	8.23	43.5	0.015	6.00X	3.33X	15.0	0.50	11.62
< 4.00% Street Slope >													
1.0	0.015	4.00X	3.33X	3.9	0.13	3.87	1.0	0.015	8.00X	3.33X	3.5	0.12	5.02
2.0	0.015	4.00X	3.33X	5.1	0.17	4.61	2.0	0.015	8.00X	3.33X	4.5	0.15	5.97
3.0	0.015	4.00X	3.33X	5.9	0.20	5.10	3.0	0.015	8.00X	3.33X	5.2	0.17	6.62
4.0	0.015	4.00X	3.33X	6.6	0.22	5.48	4.0	0.015	8.00X	3.33X	5.8	0.19	7.11
5.0	0.015	4.00X	3.33X	7.2	0.24	5.80	5.0	0.015	8.00X	3.33X	6.3	0.21	7.52
10.0	0.015	4.00X	3.33X	9.3	0.31	6.90	10.0	0.015	8.00X	3.33X	8.2	0.27	8.95
15.0	0.015	4.00X	3.33X	10.9	0.36	7.64	15.0	0.015	8.00X	3.33X	9.5	0.32	9.91
20.0	0.015	4.00X	3.33X	12.1	0.40	8.23	20.0	0.015	8.00X	3.33X	10.6	0.35	10.65
25.0	0.015	4.00X	3.33X	13.1	0.44	8.69	30.0	0.015	8.00X	3.33X	12.4	0.41	11.79
30.0	0.015	4.00X	3.33X	14.1	0.47	9.09	40.0	0.015	8.00X	3.33X	13.8	0.46	12.67
35.5	0.015	4.00X	3.33X	15.0	0.50	9.49	50.0	0.015	8.00X	3.33X	15.0	0.50	13.40
< 5.00% Street Slope >													
1.0	0.015	5.00X	3.33X	3.8	0.13	4.21	1.0	0.015	10.00X	3.33X	3.3	0.11	5.46
2.0	0.015	5.00X	3.33X	4.9	0.16	5.01	2.0	0.015	10.00X	3.33X	4.3	0.14	6.50
3.0	0.015	5.00X	3.33X	5.7	0.19	5.55	3.0	0.015	10.00X	3.33X	5.0	0.17	7.39
4.0	0.015	5.00X	3.33X	6.3	0.21	5.96	4.0	0.015	10.00X	3.33X	5.6	0.19	7.73
5.0	0.015	5.00X	3.33X	6.9	0.23	6.31	5.0	0.015	10.00X	3.33X	6.1	0.20	8.18
10.0	0.015	5.00X	3.33X	8.9	0.30	7.50	10.0	0.015	10.00X	3.33X	7.9	0.26	9.73
15.0	0.015	5.00X	3.33X	10.4	0.35	8.31	15.0	0.015	10.00X	3.33X	10.2	0.34	11.58
20.0	0.015	5.00X	3.33X	11.6	0.39	8.93	20.0	0.015	10.00X	3.33X	11.9	0.39	13.82
25.0	0.015	5.00X	3.33X	12.6	0.42	9.45	30.0	0.015	10.00X	3.33X	13.2	0.44	13.78
30.0	0.015	5.00X	3.33X	13.5	0.45	9.89	40.0	0.015	10.00X	3.33X	14.4	0.48	14.57
40.0	0.015	5.00X	3.33X	15.0	0.50	10.63	50.0	0.015	10.00X	3.33X	15.0	0.50	14.99

SOURCE:
City of
SPRINGDALE
Arkansas

FLOW IN TRIANGLE CURB SECTIONS AT
DIFFERENT STREET SLOPES

TABLE OF CONTENTS - SECTION 7

SECTION 7 - STORM DRAIN INLETS

- 7.1 General
- 7.2 Classification
- 7.3 Inlets in Sumps
 - 7.3.1 Curb Opening Inlets and Drop Inlets
 - 7.3.2 Grate Inlets
 - 7.3.3 Combination Inlets
- 7.4 Inlets on Grade Without Gutter Depression
 - 7.4.1 Curb Opening Inlets (Undepressed: Type B-1)
 - 7.4.2 Grate Inlets on Grade (Undepressed: Type B-2)
 - 7.4.3 Combination Inlets on Grade (Undepressed: Type B-3)
- 7.5 Inlets on Grade with Gutter Depression
 - 7.5.1 Curb Opening Inlets on Grade (Depressed: Type C-1)
 - 7.5.2 Grate Inlets on Grade (Depressed: Type C-2)
 - 7.5.3 Combination Inlets on Grade (Depressed: Type C-3)
- 7.6 Inlet Clogging
- 7.7 Use of Figures 7.10, 7.11, and 7.12

SECTION 7 - STORM DRAIN INLETS

7.1 GENERAL

The primary purpose of storm drain inlets is to intercept excess surface runoff and deposit it in a drainage system, thereby reducing the possibility of surface flooding.

The location of inlets, storm sewers, and other drainage appurtenances in and along streets shall be such that ponding, cross flows, and the flooding of adjacent properties are minimized or eliminated. In no case shall water be allowed to pond or spread in excess of the limits defined described in Section VI-Flow in Streets.

The most common location for inlets is in streets that collect and channelize surface flow, making it convenient to intercept. Because the primary purpose of streets is to carry vehicular traffic, inlets must be designed to avoid conflicting with that purpose.

The following guidelines shall be used in the design of inlets to be located in streets:

1. Minimum transition for depressed inlets shall be 3' per 1" depression upstream and 1' per 1" depression downstream. The use of inlets with a depression greater than 4 inches is discouraged on collector, industrial, and arterial streets unless the inlet depression is recessed a minimum of 1' behind the curb.
2. When recessed inlets are used, they shall not interfere with the intended use of the sidewalk.
3. The capacity of a recessed inlet on grade shall be calculated the same as the capacity of a similar unrecessed inlet.
4. Design and location of inlets shall take into consideration pedestrian and bicycle traffic.
5. Inlet design and location must be compatible with the criteria established in Section III of this manual.
6. Inlet extensions shall be in 4-foot increments as per AHTD.
7. Bicycle-safe grates shall be installed in area where pedestrian bicycle traffic and safety is of concern.
8. Computer programs, such as HEC-22 or HY-8, when properly used may be substituted for nomographs and other direct equations in this chapter. The use of computerized methods by experienced engineers is encouraged.

9. The City's review of the proposed Drainage Plan shall include examination of the supporting calculations. Figure 7.12, Inlet Flow Calculation Table, shall be completed and submitted for review. Computer equivalent may be substituted as long as it contains all the information shown on Figure 7.12.
10. Inlets are not allowed in radii of street intersections without approval of the City Staff.
11. Maintain grades of intersections and through cul-de-sacs to prevent ponding and deposition of solids.

12. Curb inlets shall be located on sections of straight tangents.

7.2 CLASSIFICATION

Inlets are classified into three major groups, mainly: inlets in sumps (Type A), inlets on grade without gutter depression (Type B), and inlets on grade with gutter depression (Type C). Each of the three major classes includes several varieties. The following are presented here and are likely to find reasonably wide use. (See Figures 7.1 through 7.7)

Inlets in Sumps

- | | | |
|----|------------------------------------|----------|
| 1. | Curb opening | Type A-1 |
| 2. | Grate | Type A-2 |
| 3. | Combination (grate & curb opening) | Type A-3 |
| 4. | Drop | Type A-4 |
| 5. | Drop (grate covering) | Type A-5 |

Inlets on Grade Without Gutter Depression

- | | | |
|----|------------------------------------|----------|
| 1. | Curb Opening | Type B-1 |
| 2. | Grate | Type B-2 |
| 3. | Combination (grate & curb opening) | Type B-3 |

Inlets on Grade With Gutter Depression

- | | | |
|----|------------------------------------|----------|
| 1. | Curb Opening | Type C-1 |
| 2. | Grate | Type C-2 |
| 3. | Combination (grate & curb opening) | Type C-3 |

Recessed inlets are identified by the suffix (R), (i.e.: A-1 (R)).

City Staff review of the proposed Drainage Plan shall include examination of the supporting calculations. Computations must be submitted as a part of the Plans.

7.3 INLETS IN SUMPS

Inlets in sumps are inlets placed in low points of surface drainage areas to relieve ponding. The capacity of inlets in sumps must be known in order to determine the depth and width of ponding for a given discharge. The charts in this section may be used in the design of any inlet in a sump, regardless of its depth of depression.

7.3.1 CURB OPENING INLETS AND DROP INLETS

Unsubmerged curb opening inlets (Type A-1) and drop inlets (Type A-4) in a sump at low points are considered to function as rectangular weirs with a coefficient of discharge of 3.0. Their capacity shall be based on the following equation:

$$Q = 3.0 Y^{3/2}L \quad (7-1)$$

Where,

Q = Capacity in CFS of curb opening inlet or capacity in CFS of drop inlet

Y = Head at the inlet in feet when Y is less than the height of the opening

L = Length of opening through which water enters the inlet in feet

Figure 7.8 provides for direct solution of Equation 7-1. Curb opening inlets and drop inlets in sumps have a tendency to collect debris at their entrances. For this reason, the calculated inlet capacity shall be reduced by 20 percent to allow for clogging.

7.3.2 GRATE INLETS

Generally, a grate inlet, type A-2 or A-5 in a sump, can be considered an orifice with the coefficient of discharge of 0.67. The capacity shall be based on the following:

$$Q = 5.37 A_g Y^{1/2} \quad (7-2)$$

Where,

Q = Capacity in CFS

A_g = Area of clear opening in square feet

$Y =$ Depth at inlet or head at sump in feet when Y is less than height of opening

The curve shown in Figure 7.9 provides for direct solution of the above equation.

Grate inlets in sumps have a tendency to clog when flows carry debris such as leaves and paper. For this reason, the calculated inlet capacity of a grate inlet shall be reduced by 50 percent to allow for clogging.

7.3.3 COMBINATION INLETS (TYPE A-3)

The capacity of a combined inlet type A-3 consisting of a grate and curb opening inlet in a sump shall be considered to be the sum of the capacities obtained from Figures 7.8 and 7.9. When the capacity of the gutter is not exceeded, the grate inlet accepts the major portion of the flow. Under severe flooding conditions, however, the curb inlet will accept most of the flow since its capacity varies with $y^{1.5}$, whereas the capacity of the grate varies as $y^{0.5}$.

Combination inlets in sumps have a tendency to clog and collect debris at their entrance. For this reason, the calculated inlet capacity shall be reduced by 25 percent to allow for clogging.

7.4 INLETS ON GRADE WITHOUT GUTTER DEPRESSION

7.4.1 CURB OPENING INLETS (UNDEPRESSED: TYPE B-1)

The capacity of the curb inlet, like any weir, depends upon the head and length of the opening. In the case of an undepressed curb opening inlet, the head at the upstream end of the opening is the depth of flow in the gutter. In streets where grades are greater than 1 percent, the velocities are high and the depths of flow are usually small, as there is little time to develop cross flow into the curb openings. Therefore, undepressed inlets are inefficient when used in streets of appreciable slope, but may be used satisfactorily where the grade is low and the crown slope high or the gutter channelized. Undepressed inlets do not interfere with traffic and usually are not susceptible to clogging. Inlets on grade should be designed and spaced so that 20 to 40 percent of gutter flow reaching each inlet will carry over to the next inlet downstream, provided the water carry-over does not inconvenience pedestrian or vehicular traffic.

The capacity of an undepressed inlet shall be determined by use of Figures 7.10 and 7.11. An example of the use of Figures 7.10 and 7.11 is included at the end of this section.

7.4.2 GRATE INLETS ON GRADE (UNDEPRESSED: TYPE B-2)

Undepressed grate inlets on grade have a greater hydraulic capacity than curb inlets of the same length so long as they remain unclogged. Undepressed inlets on grade are inefficient in comparison to grate inlets in sumps. For flow capacity through grate inlets, the Engineer should refer to Federal Highway publication HEC-22 or refer to an appropriate vendor catalog. Grate inlets should be designed and spaced so that 20 to 40 percent of the gutter flow reaching each inlet will carry over to the next downstream inlet, provided the carry-over does not inconvenience pedestrian or vehicular traffic.

Grates shall be certified by the manufacturer as bicycle-safe. For flows on streets with grades less than 1 percent, little or no splashing occurs regardless of the direction of the bars.

Vane grate inlets are the recommended grates for best hydraulic capacity and should be the first grate type considered on any project. The calculated capacity for a grate inlet shall be reduced by 25 percent to allow for clogging.

7.4.3 COMBINATION INLETS ON GRADE (UNDEPRESSED: TYPE B-3)

The interception capacity of a combination inlet consisting of a curb opening and grate placed side-by-side is not appreciably greater than that of the grate alone. Capacity is computed by neglecting the curb opening. A combination inlet is sometimes used with the curb opening or a part of the curb opening placed upstream of the grate. The curb opening in such an installation intercepts debris that might otherwise clog the grate and has been termed a "sweeper" by some. A combination inlet with a curb opening upstream of the grate has an interception capacity equal to the sum of the two inlets, except that the frontal flow and thus the interception capacity of the grate is reduced by interception by the curb opening.

The capacity of a Type B-3 inlet without extensions shall be considered the same as the capacity of a Type B-2 inlet. The calculated capacity for a grate inlet shall be reduced by 25 percent to allow for clogging.

7.5 INLETS ON GRADE WITH GUTTER DEPRESSION

7.5.1 CURB OPENING INLETS ON GRADE (DEPRESSED: TYPE C-1)

General. The depression of the gutter at a curb opening inlet below the normal level of the gutter increases the cross-flow toward the opening, thereby increasing the inlet capacity. Also, the downstream transition out of the depression causes backwater that further increases the amount of water captured. Depressed inlets should be used on continuous grades that exceed 1 percent, except that their use in traffic lanes shall conform to the requirements of Section VI of this manual.

The depression depth, width, length, and shape all have significant effects on the capacity of an inlet. Reference to Section 6 of this manual must be made for permissible gutter depressions.

The capacity of a depressed curb inlet will be determined by the use of Figures 7.10 and 7.11 or acceptable computer programs such as HEC-22 or HY-8. For calculation purposes “a” shall be 4 inches.

7.5.2 GRATE INLETS ON GRADE (DEPRESSED: TYPE C-2)

The depression of the gutter at a grate inlet decreases the flow past the outside of a grate. The effect is the same as that when a curb inlet is depressed, mainly that the cross slope of the street directs the outer portion of flow towards the grate.

The bar arrangements for depressed grate inlets on streets with grades greater than 1 percent greatly affect the efficiency of the inlet. Grates with longitudinal bars eliminate splash that causes the water to jump and ride over the cross bar grates, and it is recommended that grates have a minimum of transverse cross bars for strength and spacing only.

For low flows or for streets with grades less than 1 percent, little or no splashing occurs regardless of the direction of the bars. However, as the flow or street grade increases, the grate with longitudinal bars becomes progressively superior to the cross bar grate. A few small rounded crossbars, installed at the bottom of the longitudinal bars as stiffeners or as a safety stop for bicycle wheels, do not materially affect the hydraulic capacity of the longitudinal bar grates. A bicycle-safe grate must be used.

The capacity of a Type C-2 inlet on grades less than 1 percent shall be the capacity determined from Figure 7.9.

Grate inlets and depressions have a tendency to clog gutter flow carries debris such as leaves and paper. For this reason, the calculated inlet capacity of a grate inlet shall be reduced by 25 percent to allow for clogging.

7.5.3 COMBINATION INLETS ON GRADE (DEPRESSED: TYPE C-3)

The interception capacity of a combination inlet consisting of a curb opening and grate placed side-by-side is not appreciably greater than that of the grate alone. Capacity is computed by neglecting the curb opening. A combination inlet is sometimes used with the curb opening or a part of the curb opening placed upstream of the grate. The curb opening in such an installation intercepts debris that might otherwise clog the grate and has been termed a "sweeper" by some. A combination inlet with a curb opening upstream of the grate has an interception capacity equal to the sum of the two inlets, except that the frontal flow and thus the interception capacity of the grate is reduced by interception by the curb opening.

The capacity of a Type C-3 inlet without extensions shall be considered the same as the capacity of a Type C-2 inlet. For this reason, the calculated inlet capacity of a grate inlet shall be reduced by 25 percent to allow for clogging.

7.6 Inlet Clogging

Curb opening inlets and drop inlets in sumps and on grade have a tendency to collect debris and clog, reducing the hydraulic efficiency of the inlet. Clogging shall be taken into account when designing inlets, particularly in sumps.

7.7 USE OF FIGURES 7.10, 7.11, AND 7.12

Example 1

Given: $S_x = 0.03$

$$S = 0.035$$

$$Q = 5 \text{ ft.}^3/S$$

$$n = 0.016$$

- Find: (1) Q_i for a 10-ft. curb-opening inlet
(2) Q_i for a depressed 10-ft. curb opening inlet
 $a = 2$ in.
 $W = 2$ ft.

Solution:

- (1) $T = 8$ ft. (Figure 6.3)
 $L_T = 41$ ft. (Figure 7.10)
 $L/L_T = 10/41 = 0.24$
 $E = 0.39$ (Figure 7.11)
 $Q_i = EQ = 0.39 \times 5 = 2.0 \text{ ft}^3/\text{S}$
- (2) $T = 7.0$ ft. (Figure 6.3)
 $W/T = 2/7 = 0.29$
 $E_o = 0.72$ (Figure 6.5)
 $S_e = S_x + S_w E_o = 0.03 + 0.083 (0.72) = 0.09$
- $L_T = 23$ ft- (Figure 7.10)
 $L/L_T = 10/23 = 0.43$
 $E = 0.64$ (Figure 7.11)
 $Q_i = 0.64 \times 5 = 3.2 \text{ ft}^3/\text{S}$

EXAMPLE 2 (Use of Figure 7.12)

Figure 7.12

RUNOFF AND INLET COMPUTATIONS

-
- Column 1: Inlet number. All inlets are classified with a designated number.
- Column 2: Inlet location. Location or station of inlet.
- Column 3: A - Drainage area in acres contributing runoff to the inlet.
- Column 4: C - Average or composite runoff coefficient of the area, A, contributing runoff to the inlet.
- Column 5: Tc - Time of concentration for the drainage area in minutes. See section II.
- Column 6: i - Rainfall intensity in inches per hour for the design storm. Based on the time of concentration. See Table 2.2.
- Column 7: CA for the drainage area. Equal to Column 3 multiplied by Column 4.
- Column 8: Carry over, CA, from preceding inlet (Column 27).

Column 9: Q_t - Total flow at the inlet. Equal to the sum of the values in Column 7 and Column 8 multiplied by the value in Column 6 or

$$Q_t = i * \Sigma CA$$

Column 10: n - Manning's roughness coefficient for the gutter section.

Column 11: S - the slope of the gutter profile in feet per foot.

Column 12: S_x - Cross slope of the roadway section at the inlet in feet per foot.

Column 13: T - Ponded width of flow in the street/gutter in feet. Obtained from Figure 6.3.

Column 14: d - Depth of flow in the gutter section of the inlet in feet. Obtained from Figure 6.2 or

$$d = T * S_x$$

Column 15: V - Velocity of flow in gutter in feet per second. Equal to Column 9 divided by one half of Column 13 multiplied by Column 14 or

$$V = Q/A$$

Column 16: L - Length of the inlet in feet.

Column 17: a - Depth of the gutter depression at the inlet in inches.

Column 18: W - Width of the gutter depression at inlet in feet.

Column 19: E_o - Ratio of frontal flow to total flow. Obtained from Figure 6.4 or

$$E_o = Q_w/Q - 1 - (1 - W/T)^{2.67}$$

Column 20: S_e - Equivalent cross slope of the pavement at the inlet in feet per foot:

$$S_e = \frac{S_x + (a/12w) * E_o}{E}$$

Column 21: L_t - required length of inlet in feet for total flow interception. Obtained from Figure 7.10.

Column 22: E - Efficiency of the inlet of length L . Obtained from Figure 7.11.

Column 23: Q_i - Flow intercepted by the inlet of length L in CFS. Equal to Column 22 multiplied by Column 9 or

$$Q_i = Q_t * E$$

Column 24: RF - Clogging reduction factor for the inlet.

Column 25: Q_a - Actual flow intercepted by the inlet in CFS. Equal to Column 23 multiplied by Column 24 or

$$Q_a = Q_i * RF$$

Column 26: Q_p - Bypass flow in CFS. Equal to Column 25 subtracted from Column 9 or

$$Q_p = Q_t - Q_a$$

Column 27: Carry over, CA, for the next downstream inlet. Equal to Column 26 divided by Column 6 or

$$\text{Carry over} = Q_p/i$$

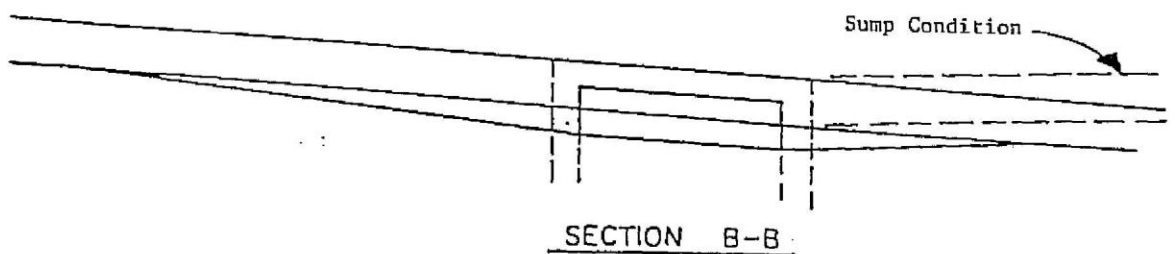
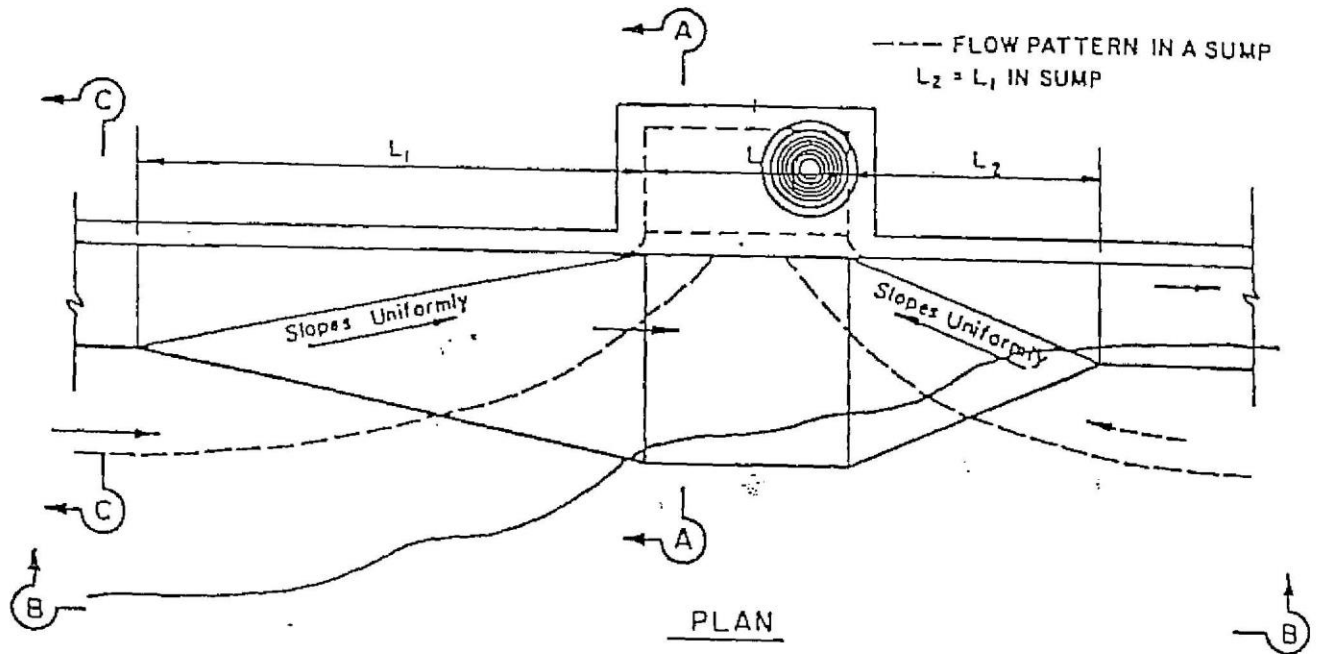

$$E = y_0 + \frac{y_0^2}{2g} + a$$

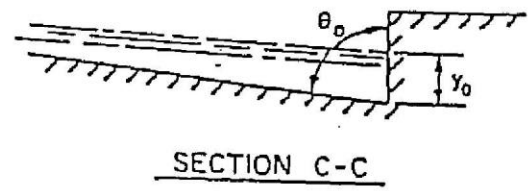
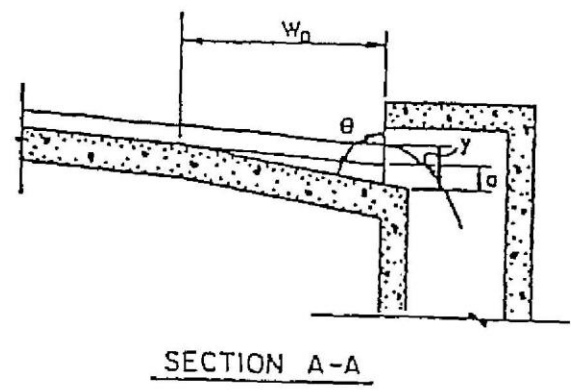

DEPRESSED CURB-OPENING INLET
 TYPE A-1 & C-1

Source: City of Austin, Tx.

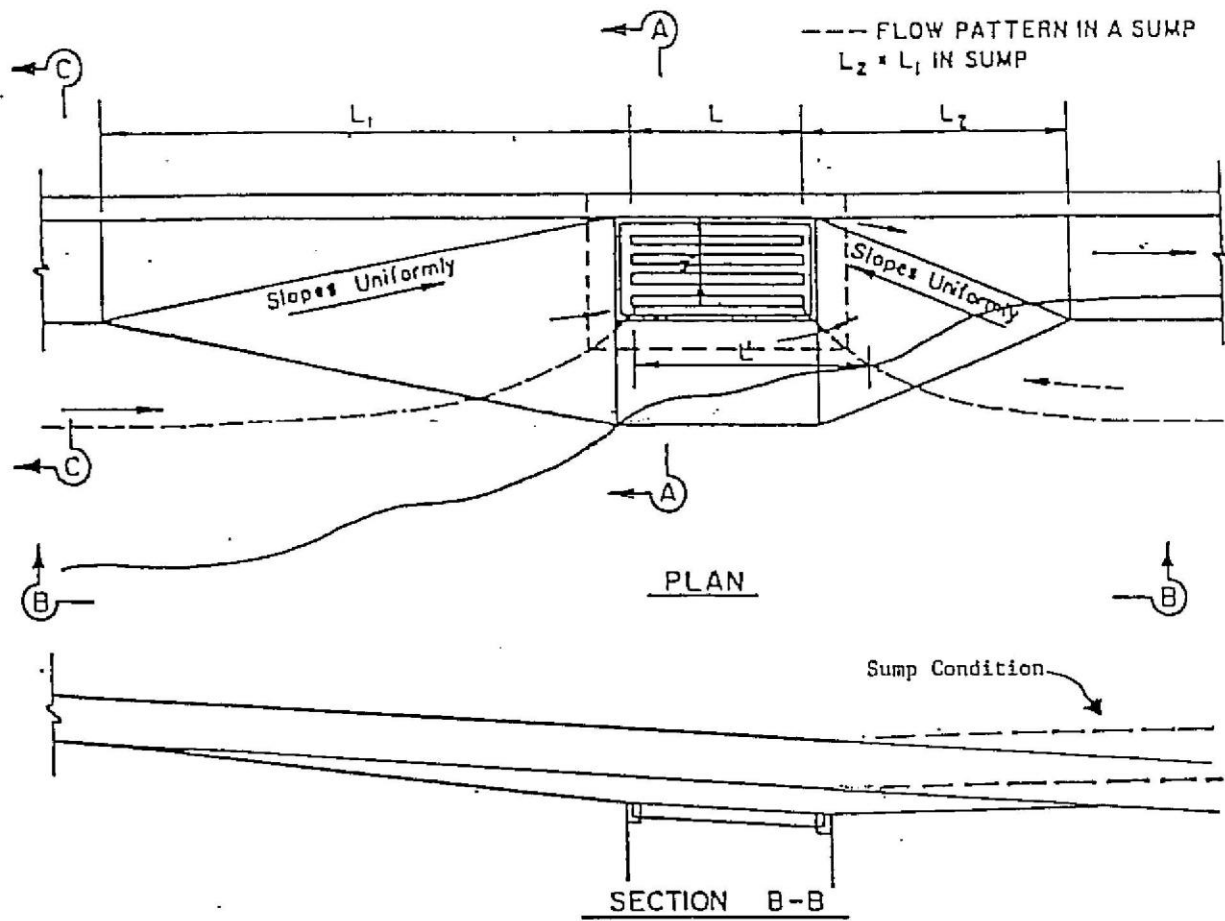

$$E = y_0 + \frac{v_0^2}{2g} + a$$

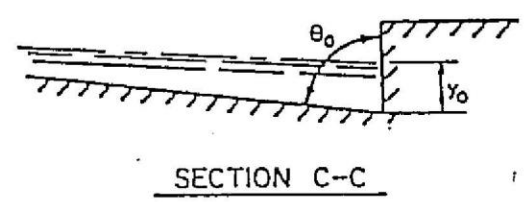
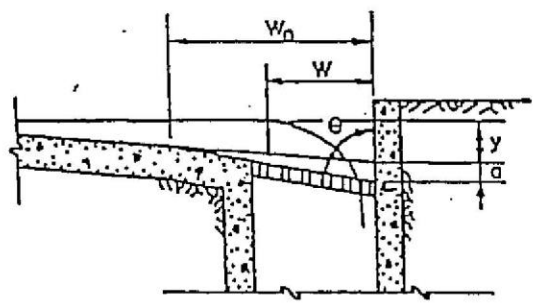

DEPRESSED GRATE INLET
 TYPE A-2 & C-2

Figure 7.2

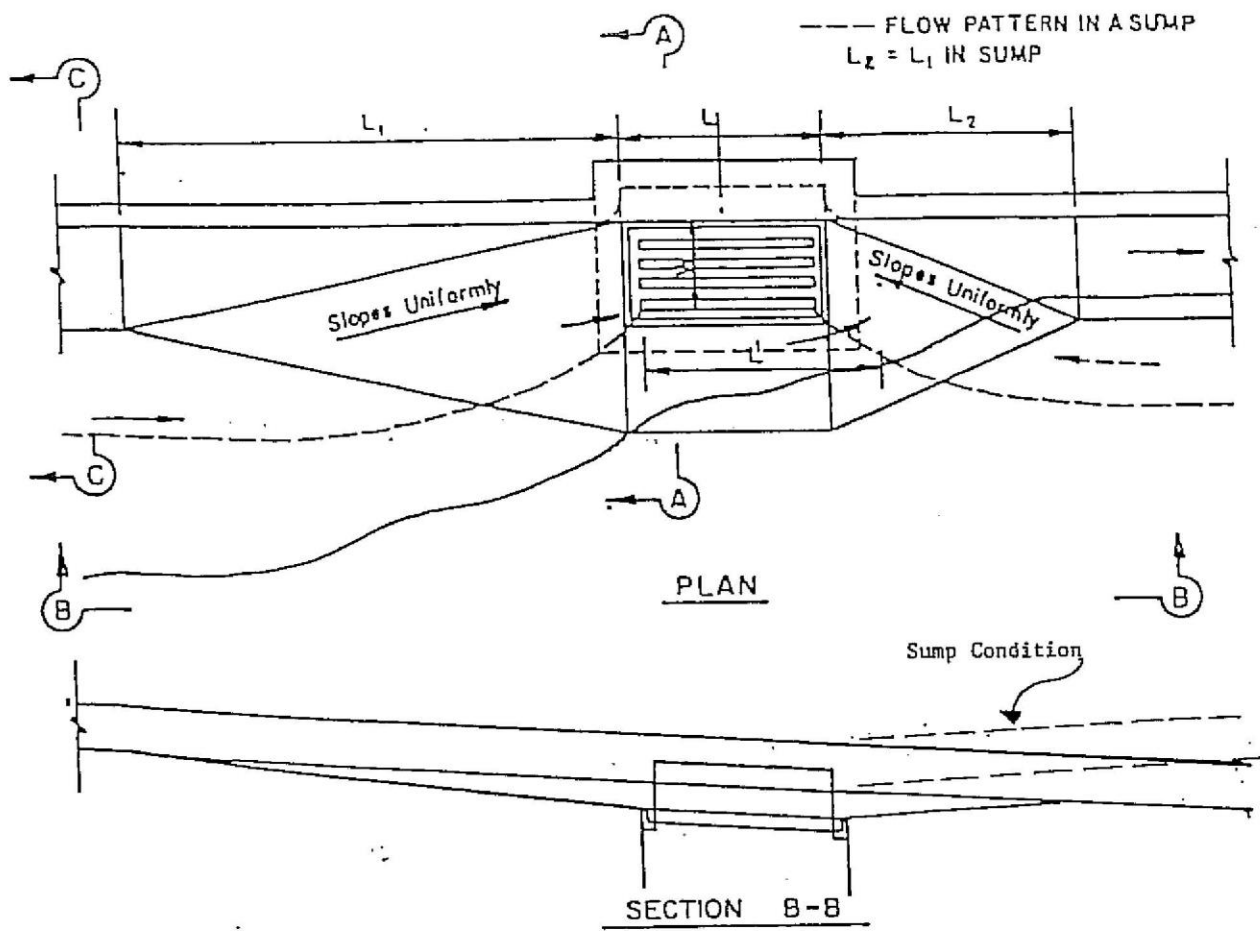

$$E = y + \frac{v_0^2}{2g} + a$$

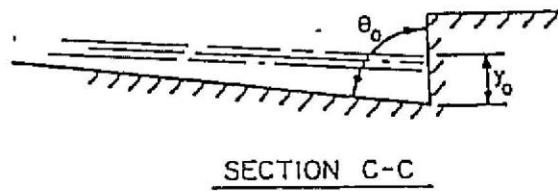
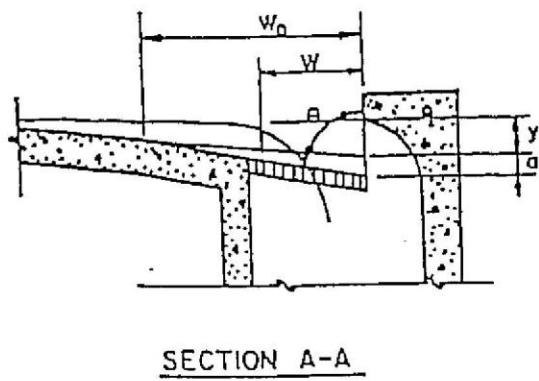

DEPRESSED COMBINATION INLET
 TYPE A-3 & C-3

Figure 7.3

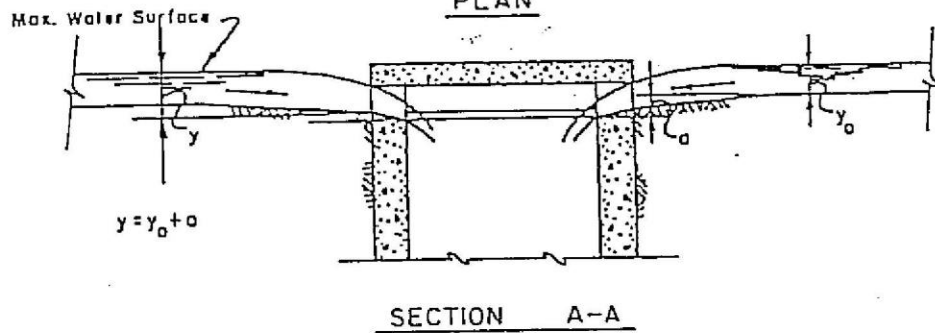
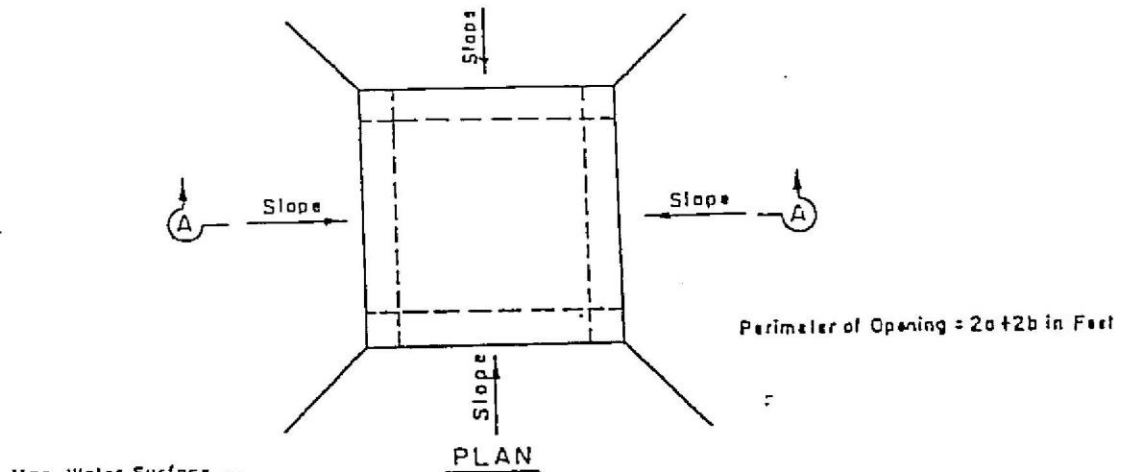

DROP INLET
TYPE A-4

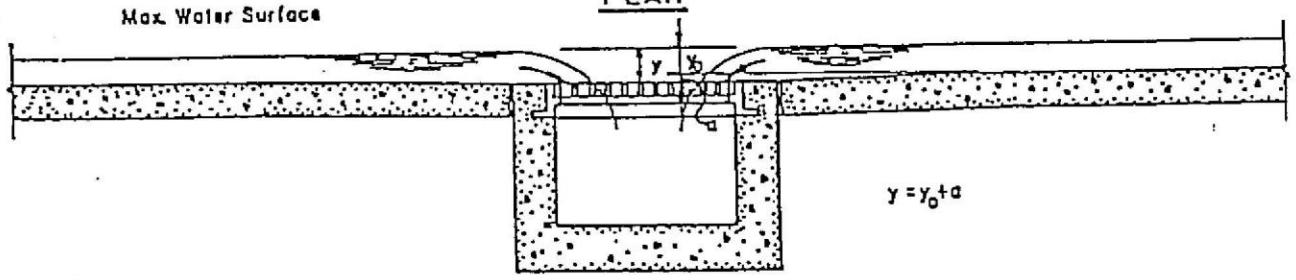
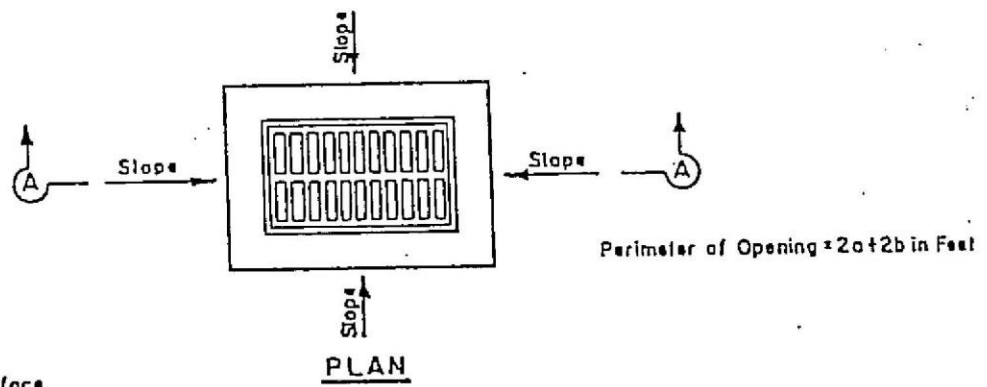

DROP INLET
(Grate covering)
Type A-5

DROP INLET (Grate Covering) Type A-4 and DROP INLET (Grate Covering) TYPE A-5

Figure 7.4

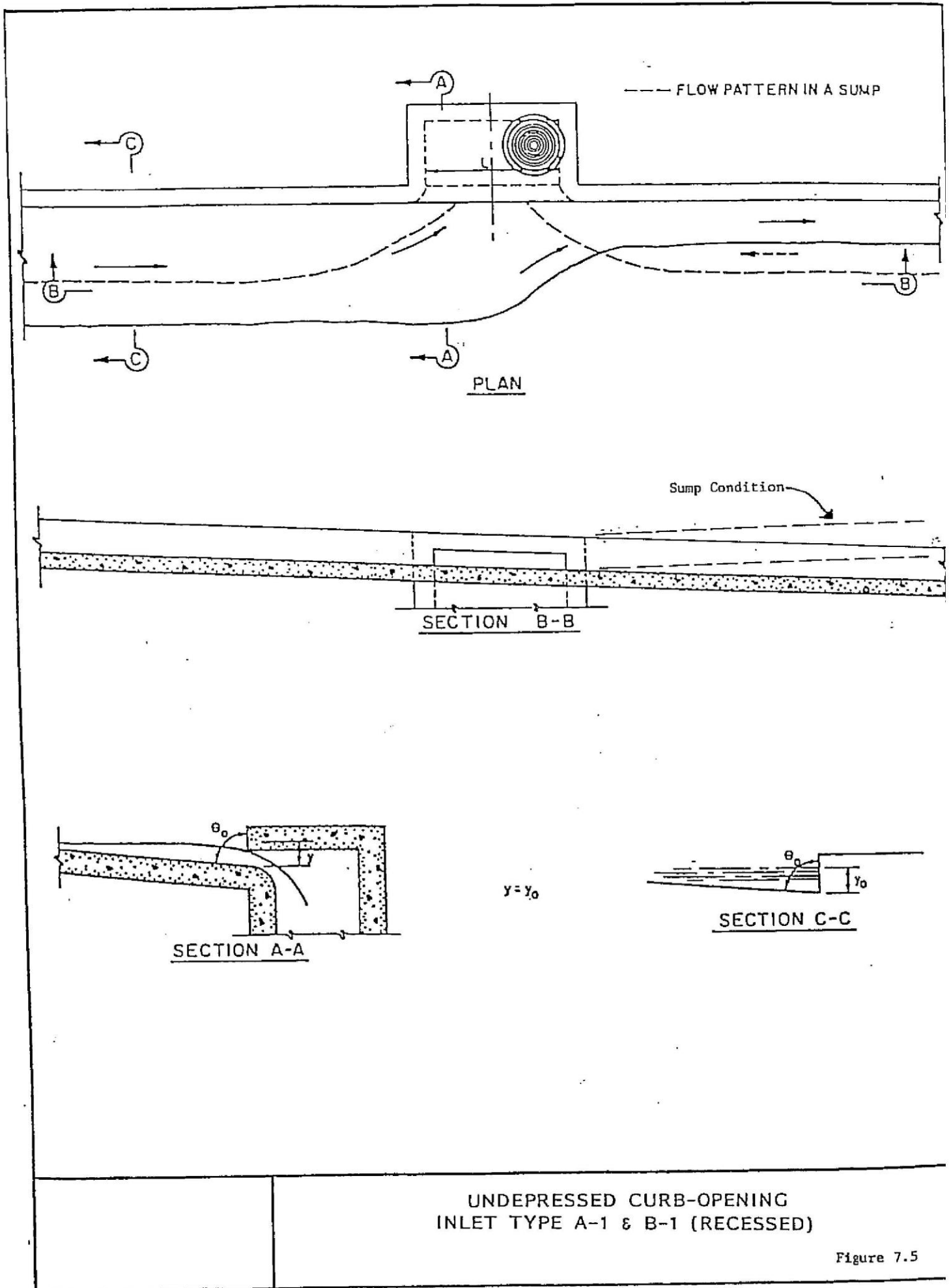

UNDEPRESSED CURB-OPENING
 INLET TYPE A-1 & B-1 (RECESSED)

Figure 7.5

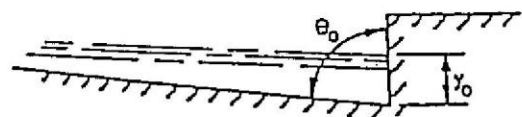
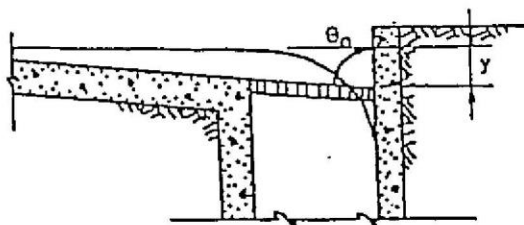
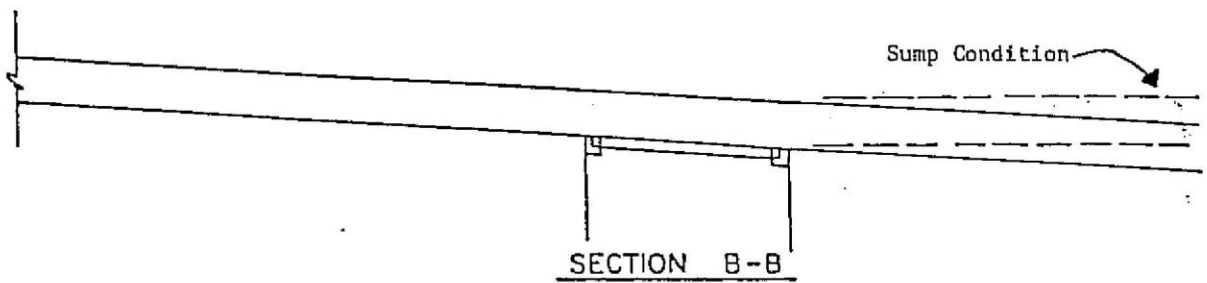
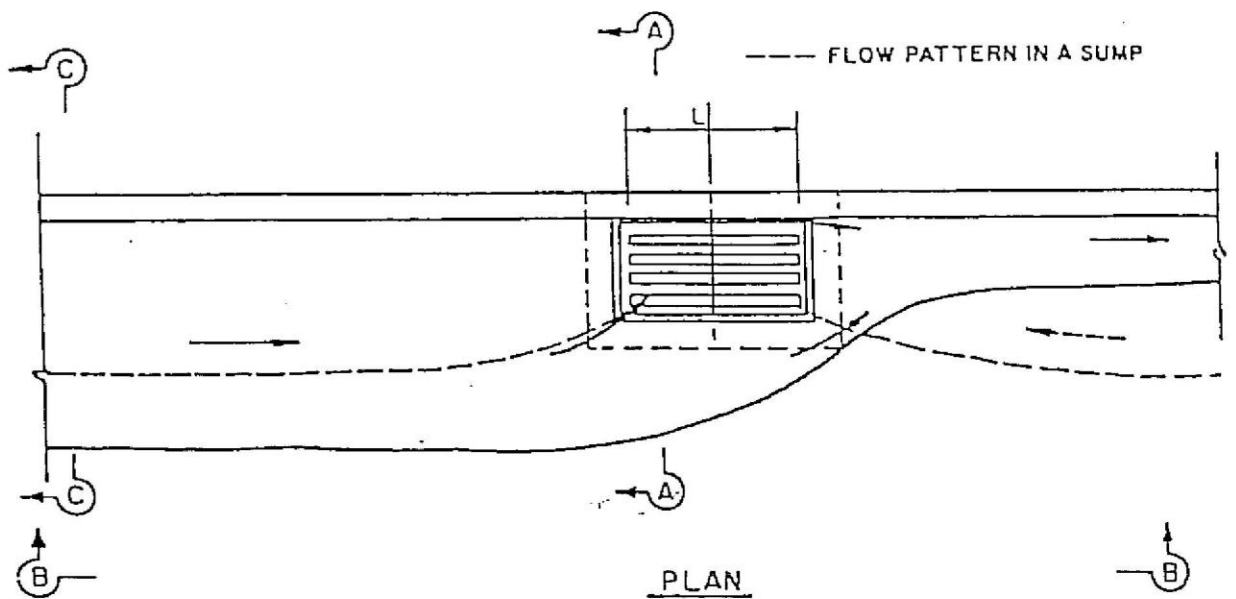

$$y = y_0$$

UNDEPRESSED GRATE INLET
TYPE A-2 & B-2

Figure 7.6

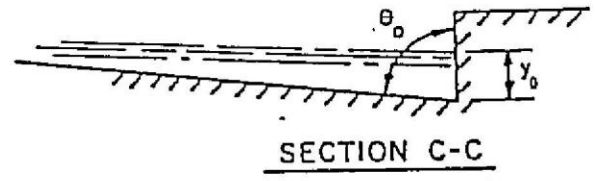
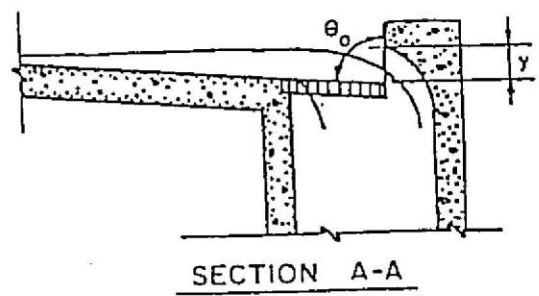
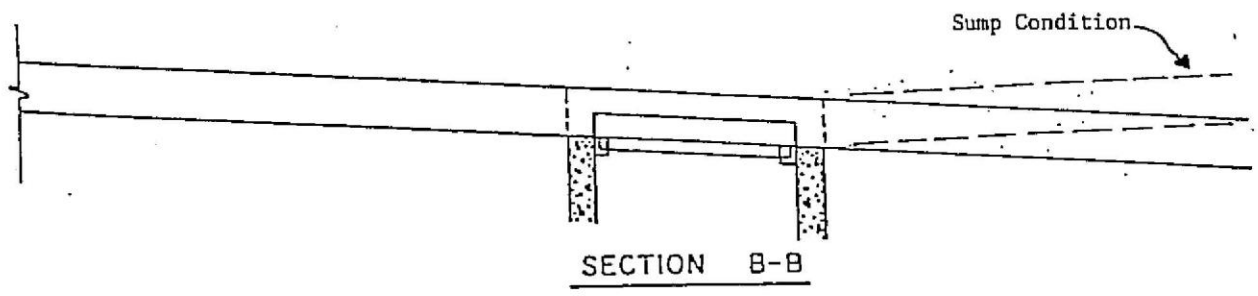
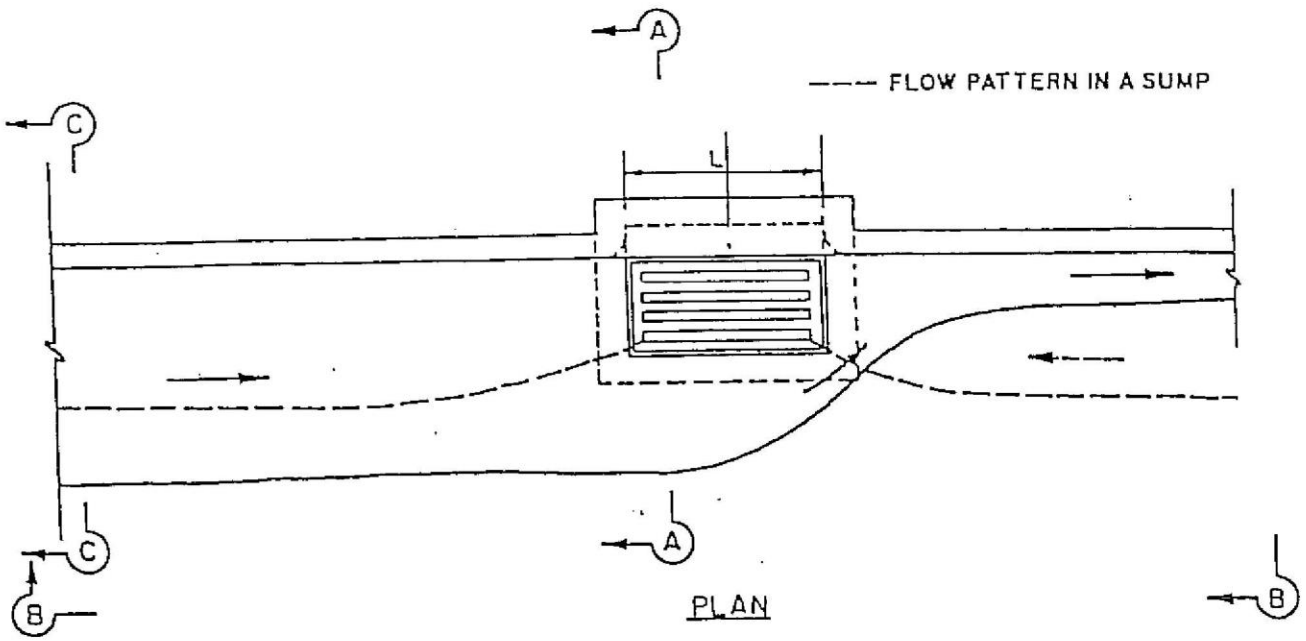

$y = y_0$

UNDEPRESSED COMBINATION
INLET TYPE A-3 & B-3 (RECESSED)

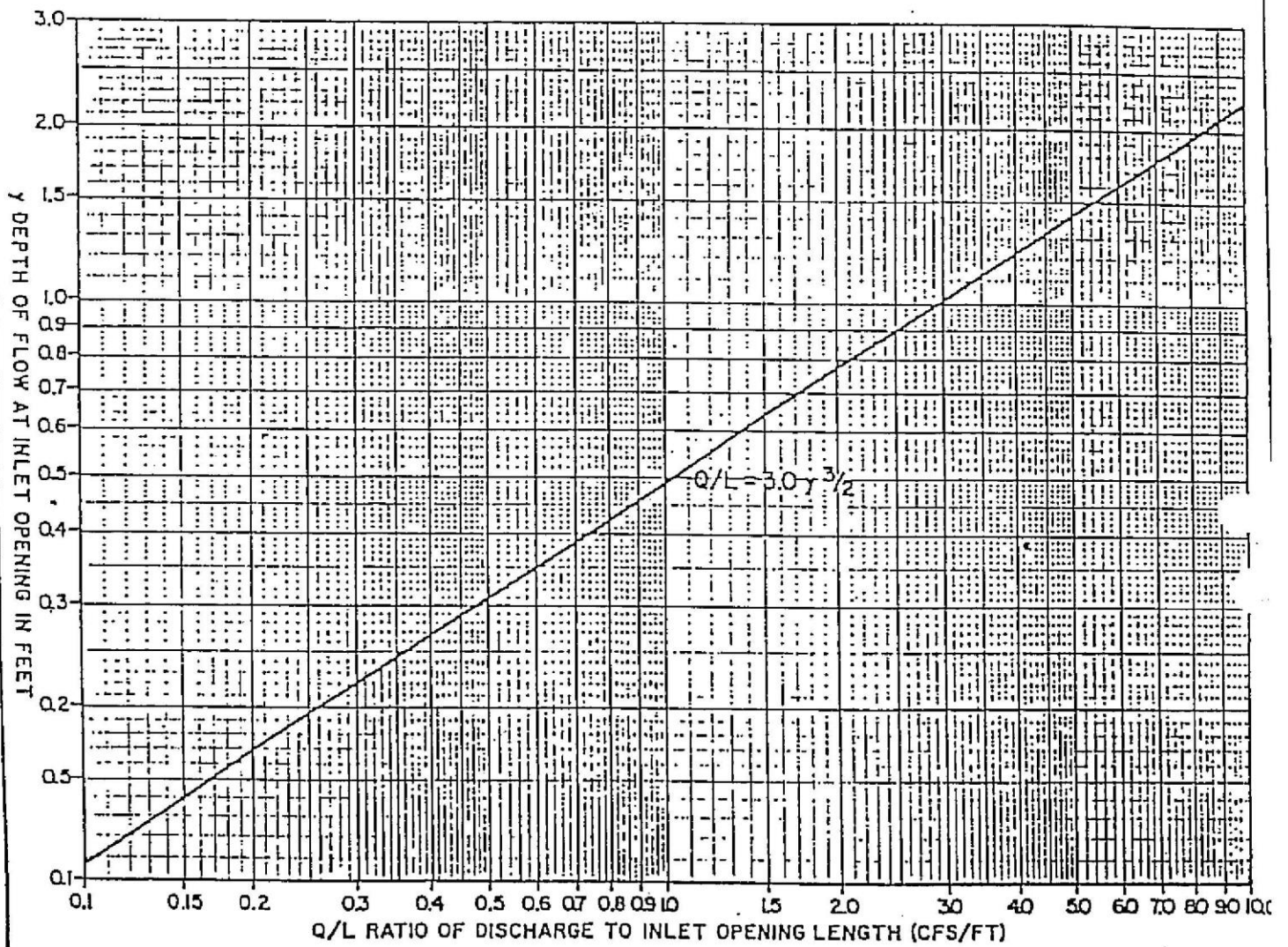

INLET CAPACITY TYPE A-1 & A-4

Source: City of Little Rock, AR

Figure 7.8

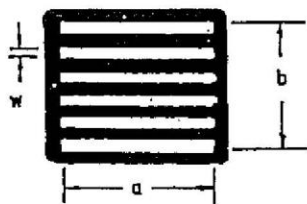
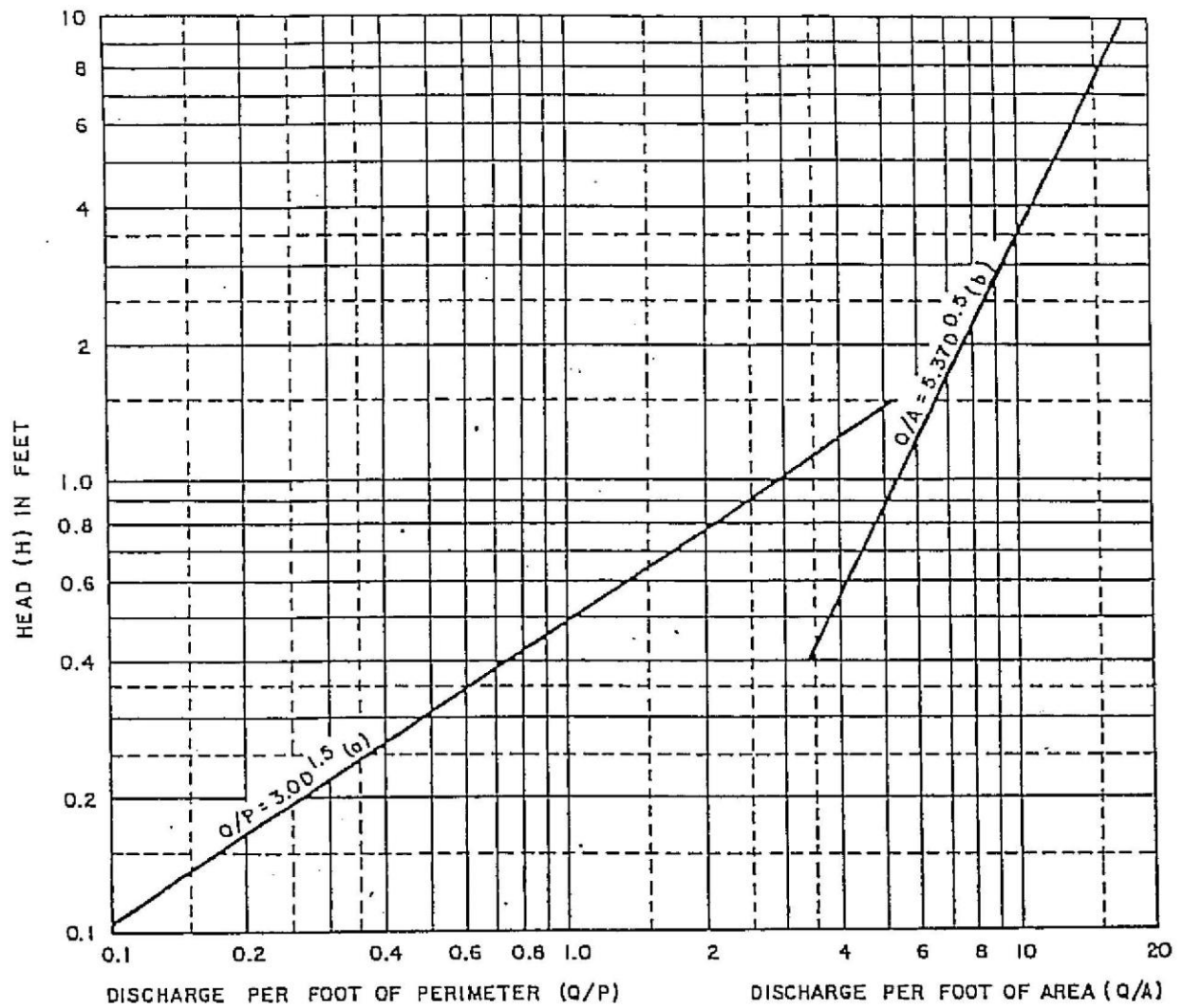

$P = 2(a + b)$
 $A = 6aw$

HEADS UP TO 0.4, CURVE (a) APPLIES
 HEADS ABOVE 1.4, CURVE (b) APPLIES
 HEADS BETWEEN 0.4 & 1.4, TRANSITION
 SECTOR, USE LESSOR VALUE OF DISCHARGE

CAPACITY OF GRATE INLET
 IN SAG

INLET CAPACITY TYPE A-2 & A-5

Source: AHTD

Figure 7.9

$$L_T = 0.6Q^{0.42} S^{0.3} (1/nS_x)^{0.6}$$

FOR COMPOSITE CROSS SLOPES, USE S_c FOR S_x .

$$S_c = S_x + S_w E_o \quad ; \quad S_w = O/W$$

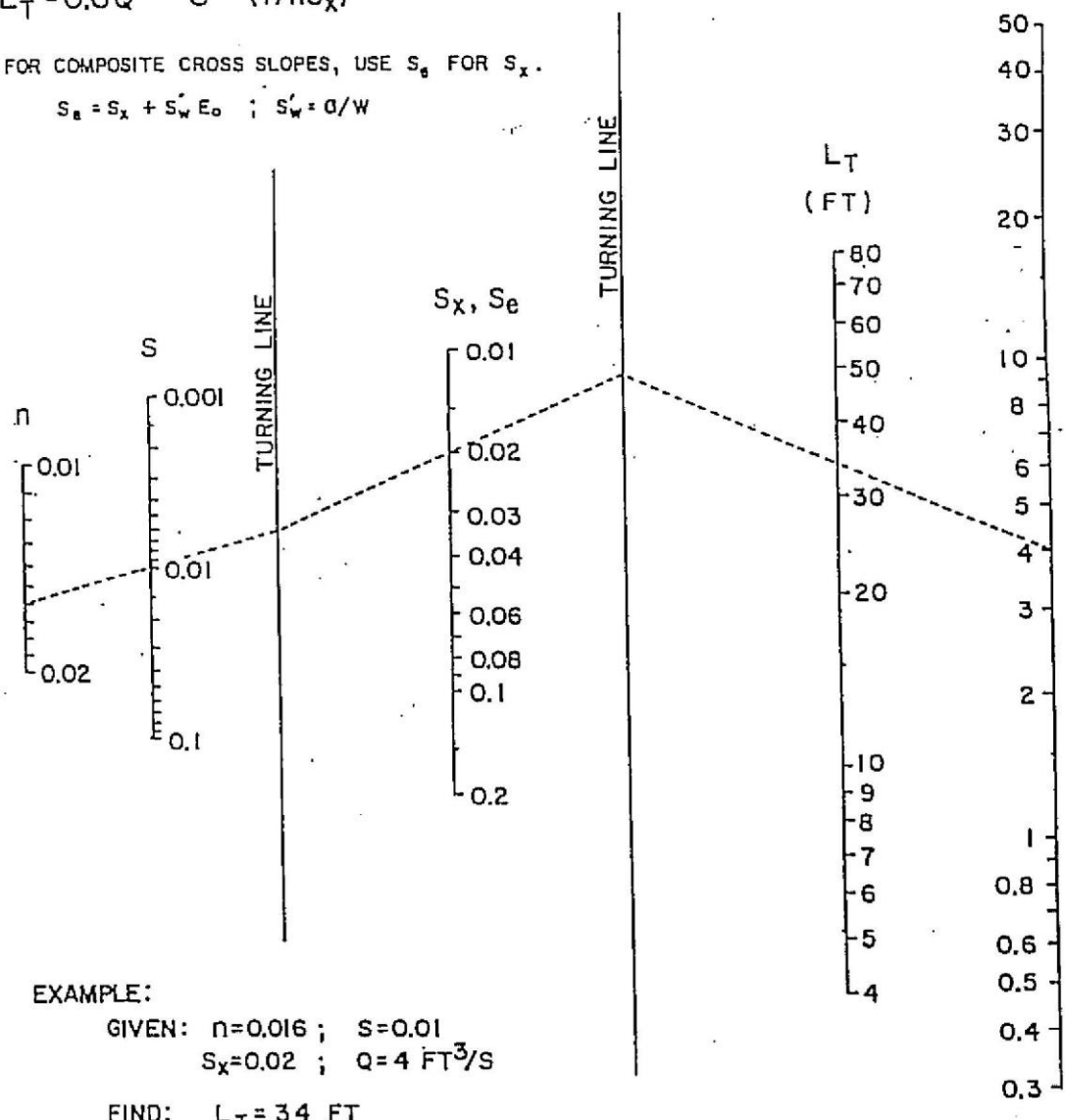
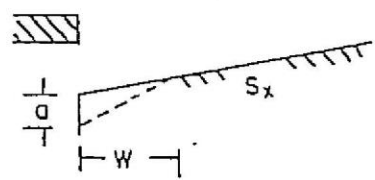

EXAMPLE:

GIVEN: $n=0.016$; $S=0.01$
 $S_x=0.02$; $Q=4 \text{ FT}^3/\text{S}$

FIND: $L_T = 34 \text{ FT}$

Source: Federal Highway Administration - Circular 12

CURB-OPENING AND SLOTTED DRAIN INLET LENGTH FOR TOTAL INTERCEPTION

Figure 7.10

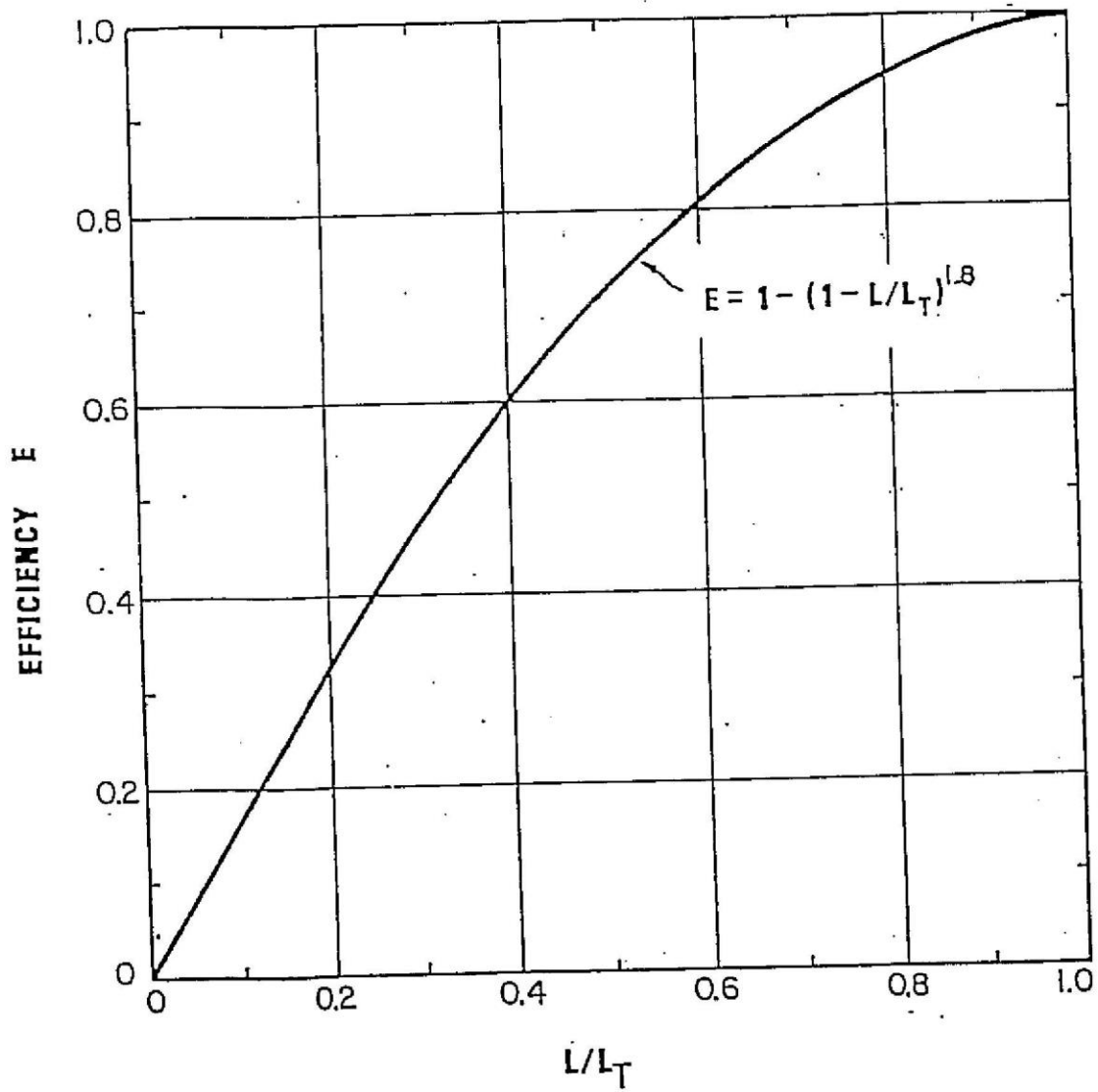

Source: Federal Highway Administration - Circular 12

CURB-OPENING AND SLOTTED DRAIN INLET
INTERCEPTION EFFICIENCY

Figure 7.11

TABLE OF CONTENTS - SECTION 8

SECTION 8 - STORM SEWER SYSTEM DESIGN

- 8.1 General
- 8.2 Design Considerations
- 8.3 Inlet System
- 8.4 Storm Sewer System
 - 8.4.1 Storm Sewer Pipe
 - 8.4.2 Junctions, Inlets, and Manholes
 - 8.4.3 Storm Sewer Capacity and Velocity
 - 8.4.4 Proportioning Storm Sewer Pipes
 - 8.4.5 Hydraulic Grade Line

SECTION 8 - STORM SEWER SYSTEM DESIGN

8.1 GENERAL

All storm drains shall be designed by the application of Manning's Equation either directly or through appropriate charts or nomographs. The use of Manning's Equation is not appropriate for the design of culverts (see Section 4—Culvert Hydraulics). In the preparation of hydraulic designs, a thorough investigation shall be made of all existing structures and their performance on the waterways in question.

The location of inlets, storm sewers, and other drainage appurtenances in and along streets shall be such that ponding, cross flows, and the flooding of adjacent properties are minimized or eliminated.

Where storm drainage crosses between lots to continue into other facilities, a swale shall be constructed to allow flows in excess of the design flows. When storm sewers are designed for the 50-year peak flow and are not within a public street, a drainage easement shall be provided that prohibits structures from blocking that flow. The easement shall be sized to pass the 50-year flow. The 100-year water surface elevation shall be plotted on the design drawings.

The design of the storm drainage systems should be governed by the following conditions:

- A. The system must accommodate all surface runoff resulting from the selected design storm without serious damage to physical facilities or substantial interruptions of normal traffic.
- B. Runoff resulting from storms exceeding the design storm must be anticipated and disposed of with minimum damage to physical facilities and minimum interruption of normal traffic.
- C. The storm drainage system must have a maximum reliability of operation.
- D. The construction cost of the system must be reasonable with relationship to the importance of the facilities it protects.
- E. The storm drainage system must require minimum maintenance and must be accessible for maintenance operations.
- F. The storm drainage system must be adaptable to future expansion with minimal additional costs.

An example of the design of the storm drainage system is outlined in Sections 8.3 and 8.4. The design theory has been presented in the preceding sections with corresponding tables and graphs of information.

8.2 DESIGN CONSIDERATIONS

- A. Prepare a Drainage Map of the entire area to be drained by proposed improvements. Contour maps serve as excellent area drainage maps when supplemented by field reconnaissance.
- B. Make a tentative layout of the proposed storm drainage system, locating all inlets, manholes, mains, laterals, ditches, culverts, etc., including existing utilities.
- C. Outline the drainage area for each inlet in accordance with present and future street development.
- D. Indicate on each drainage area the size of the area, the direction of surface runoff by small arrows, and coefficient of runoff for the area.
- E. Show all existing underground utilities.
- F. Establish design rainfall frequency.
- G. Establish minimum inlet time of concentration.
- H. Establish the typical cross section on each street.
- I. Establish permissible spread of water on all streets within the drainage area.

8.3 INLET SYSTEM

Determining the size and location of inlets is largely a trial-and-error procedure. Using criteria outlined in earlier sections of this manual, the following steps will serve as a guide to the procedure to be used:

- A. Beginning at the upstream end of the project drainage basin, outline a trial sub-area and calculate the runoff from it.
- B. Compare the calculated runoff to allowable street capacity. If the calculated runoff is greater than the allowable street capacity, reduce the size of the trial sub-area. If the calculated runoff is less than street capacity, increase the size of the trial sub-area. Repeat this procedure until the calculated runoff equals the allowable street capacity. This is the first point at which a portion of the flow

must be removed from the street. The percentage of flow to be removed will depend on street capacities versus runoff entering the street downstream.

- C. Record the drainage area, time of concentration, runoff coefficient, and calculated runoff for the sub-area. This information shall be recorded in the drainage report, using Figure 7.12. Computerized printouts may be substituted, provided they are legible and contain all the information shown on Figure 7.12.
- D. If an inlet is to be used to remove water from the street, size the inlet(s), and record the inlet size and amount of intercepted flow, and amount of flow carried over (bypassing the inlet).
- E. Continue the preceding procedure for other sub-areas until a complete system of inlets has been established. Remember to account for carry-over from one inlet to the next.
- F. After a complete system of inlets has been established, modification should be made to accommodate special situations, such as point sources of large quantities of runoff, and variation of street alignments and grades.
- G. Record information as in C. and D. for all inlets.
- H. After the inlets have been located and sized, the inlet pipes can be designed.
- I. Inlet pipes are sized to carry the volume of water intersected by the inlet. Inlet pipe capacities may be controlled by the gradient available or by entry condition into the pipe at the inlet. Inlet pipe sizes should be determined for both conditions, and the larger size thus determined should be used.

8.4 STORM SEWER SYSTEM

After the computation of the quantity of runoff entering each inlet, the storm sewer system required to carry the runoff is designed. It should be borne in mind that the quantity of flow to be carried by any particular section of the storm sewer system is not the sum of the inlet design quantities of all inlets above that section of the system, but is less than the mathematical sum. This situation is due to the fact that as the time of concentration increases the rainfall intensity decreases. However, this decrease will be minimal for short runs of storm sewer pipes.

8.4.1 STORM SEWER PIPE

The finished ground profile is now used in conjunction with the previous runoff calculations. The maximum elevation of the hydraulic gradient for the design storm is 1' below the finished ground or 1' below the bottom of

the gutter line, or as approved by the City Staff. When this tentative gradient is set and the design discharge is determined, a Manning flow chart may be used to determine the pipe size and velocity.

It is probable that the tentative gradient will have to be adjusted at this point since the intersection of the discharge in the slope on the chart will likely occur between standard pipe sizes. The smaller pipe should be used if the design discharge and corresponding slope does not result in an encroachment on the 1' criteria below the finished ground. If there is an encroachment, use the larger pipe that will establish a capacity somewhat in excess of the design discharge. Velocities can be read directly from a Manning's flow chart based on a given discharge, pipe size, and gradient slope.

8.4.2 JUNCTIONS, INLETS, AND MANHOLES

- A. Determine the hydraulic gradient elevation at the upstream end and downstream end of the pipe section in question. The elevation of the hydraulic gradient of the upstream end of the pipe is equal to the elevation of the downstream hydraulic gradient plus the product of the length of the pipe times the friction slope.
- B. Determine the velocity of flow for incoming pipe (main line) at junction, inlet, or manhole at design point.
- C. Determine the velocity of flow for outgoing pipe (main line) at junction, inlet, or manhole at design point.
- D. Compute velocity head for outgoing velocity (main line) at junction, inlet, or manhole at design point.
- E. Compute velocity head for incoming velocity (main line) at junction, inlet, or manhole at design point.
- F. Determine head loss coefficient "K" at junction, inlet, or manhole at design point from Tables 3.4, 3.5, 3.6, or Figures 3.10 or 3.11.
- G. Compute head loss at junction, inlet, or manhole:

$$h_j = K_j (v_2^2 - V_1^2)/2g$$

- H. Compute hydraulic gradient at upstream end of junction as if junction were not there.

- I. Add head loss to hydraulic gradient elevation determined to obtain hydraulic gradient elevation at upstream end of junction.

A plotted hydraulic grade line shall be shown on the plans, and all calculations and pertinent information shall be recorded in the drainage report, in tabular form convenient for review.

8.4.3 STORM SEWER CAPACITY AND VELOCITY

The capacity and velocity shall be based on the Manning's "n"-values. The maximum full flow velocity shall be 20 fps. The City Staff may approve higher velocities if the design includes adequate provisions for uplift forces, dynamic impact forces, and abrasion. The minimum velocity in a pipe based on full flow shall be 2.5 fps to avoid excessive accumulations of sediment.

The energy grade line (EGL) for the design flow shall be no more than 1 foot above the final grade at manholes, inlets, or other junctions. To ensure that this objective is achieved, the hydraulic grade line (HGL) and the EGL shall be calculated by accounting for pipe friction losses and pipe form losses. Total hydraulic losses will include friction, expansion, contraction, bend, manhole, and junction losses. The methods for estimating these losses are presented in the following sections.

8.4.4 PROPORTIONING STORM SEWER PIPES.

The computations involved in proportioning various runs of sewer pipe are summarized in the tabulation sheet titled "Storm Sewer Computations, Table 8.1.

- | | |
|-----------|---|
| Column 1: | Inlet Number - Enter the inlet number. |
| Column 2: | Inlet Location - Enter the station and location of the inlet. |
| Column 3: | Inlet CA from the Inlet Flow Calculation Table, Figure 7.12, the quotient of Column 25. Column 6 or Column 27 is used to obtain the CA product to be entered in Column 3. Only structures contributing flow to the system should have values in Column 3. |
| Column 4: | Other CA - Enter the CA product of flow from any contributing upstream structure. |
| Column 5: | Structure No. - Number the inflowing structure. |

Column 6: Total CA - Enter the sum of Columns 3 and 4.

Columns 7, 8, & 9: The time of concentration is the time required for water to flow from the most remote part of the drainage area or areas involved to the upper end of the pipe run under consideration. The first run time of concentration is the inlet time for the first inlet. For all succeeding runs, time of concentration may be either the time as computed along the sewer line or the inlet time of the inlet at the beginning of the run under consideration, depending upon which of these two periods is longer. Accordingly, the larger of the two is used in determining "I" and "Q", unless this larger value is less than 10 minutes, in which case the established minimum time of 5 minutes is used for an industrial/commercial watershed and 10 minutes for a residential watershed.

The time of concentration shown in Column 7 is computed by taking the time of concentration for the preceding run and adding it to the time required for water to flow through the preceding run to the beginning of the run under consideration.

At junctions of lines, the larger value of the time of concentration is used.

Column 10: i - Rainfall intensity in inches per hour for the design storm. Base on T_c . See Figure 2.5.

Column 11: Q_t - Total flow in pipe in CFS. Equal to the product of Column 6 times Column 10.

Columns 12, 13, 14, and 15:

Pipe Characteristics - The size and gradient of pipe as shown in Columns 12, 13, 14, & 15 must be chosen in such a manner that the pipe when flowing full, but not under head, will carry an amount of water approximately equal or greater than the computed discharge, "Q". In other words, the "Capacity" shown in Column 15 must be approximately equal to or greater than the value "Q" shown in Column 11.

The capacity may be calculated by Manning's Equation:

$$Q = \frac{1.486}{n} AR^{2/3} S^{1/2}$$

or capacity can be taken directly from the appropriate nomographs in Sections III and IV.

Whenever a pipe run is designed in such a manner that the capacity of a pipe as shown in Column 15 is less than the computed discharge shown in Column 11, a check of the hydraulic gradient above this run should be made to ensure that the backwater head created by such a design is not large enough to cause blowouts at inlets or junctions above the run.

Column 16: The velocities shown in this column can be calculated by Manning's Equation:

$$V = 1.486 R^{2/3} S^{1/2}$$

or the velocities can be taken directly from the appropriate graphs or figures in Sections III and IV.

Column 17: L - the length of each run as shown in this column is the length center to center of inlets or junctions in feet. This length is used in determining the time of flow from one inlet or junction to another.

Column 18: Pipe T_c - the time of concentration in the pipe under consideration is actual flow time, in minutes from the present inlet to the next junction point. Run time is calculated by dividing the length of run (Column 17) by velocity of flow (Column 16) and converting the answer to minutes by dividing by 60.

Columns 19 to 24:

These columns are believed to be self-explanatory.

8.4.5 HYDRAULIC GRADE LINE

The final step in designing a storm sewer is to plot and check the HGL. Computing the HGL will determine the elevation under design conditions to which water will rise in various inlets, manholes, junctions, and etc.

The HGL shall be computed for all storm sewer systems. Computations are summarized in tabulation sheet entitled "Hydraulic Grade Line," Table 8.2.

- Column 1: Inlet Station - Enter the station for the junction immediately upstream of the outflow pipe. HGL computations begin at the outfall and are worked upstream taking each junction into consideration.
- Column 2: Outlet Water - Surface Elevation - Enter tailwater elevation in feet if the outlet will be submerged during the design storm, or 0.8 diameter of pipe plus invert out elevation of the outflow pipe, whichever is greater.
- Column 3: D_o - Enter diameter of outflow pipe in inches.
- Column 4: Q_o - Enter design discharge for outflow pipe in CFS.
- Column 5: L_o - Enter length of outflow pipe in feet.
- Column 6: S_f - Enter friction slope in feet/foot of the outflow pipe using the Manning's Equation:
- $$S_f = \frac{Q_n^2}{[1.486 AR^{2/3}]^2}$$
- Column 7: H_f - Enter friction loss by multiplying Column 5 by Column 6.
- Column 8: V_o - Enter velocity of the outflow pipe in fps.
- Column 9: Q_i - Enter design discharge (Q_1 Q_2 $Q_3...$) in CFS for each pipe flowing into the junction.
- Column 10: V_i - Enter velocity (V_1 , V_2 $V_3...$) in fps for each pipe flowing into the junction.
- Column 11: H_{tm} - Enter terminal junction losses in feet for the upper reach of each storm sewer run using the formula:
- $$H_{tm} = \frac{V^2}{2g}$$
- Column 12: H_e - Enter pipe entrance losses in feet for the upper reach of each storm sewer run using the formula:
- $$H_e = \frac{K V^2}{2g}$$

Where,

$K = 0.5$ for square-edge

Column 13: Enter junction losses H_{j1} or H_{j2} in feet for each junction using the formula:

$$H_{j1} = \frac{V^2 \text{ outflow}}{2g}$$

or:

$$H_{j2} = \frac{Q_4 V_4^2 - Q_1 V_1^2 - Q_2 V_2^2 + K Q_1 V_1^2}{2g Q_4}$$

Column 14: H_b - Enter bend losses (changes in direction of flow) in feet for each inflowing pipe to the outflow pipe using the formula:

$$H_b = \frac{K V^2}{2g}$$

Refer to Section III for "K" values.

Column 15: H_t - Enter total head losses in feet using the formula:

$$H_t = H_f + H_{tm} + H_c + H_{j1} \text{ or } H_{j2} + H_b$$

Column 16: HGL - Enter the new hydraulic grade in feet by summing elevations in Column 2 and Column 15. This elevation is the potential water surface elevation for the junction under design conditions.

Column 17: Enter the top of junction cover or the gutter flow line, whichever is lowest, and compare it with the HG in Column 16.

If STORM CAD or other software is used, the printed results may be submitted in lieu of Table 8.2, as long as all items are included. The use of computerized methods by experienced engineers is encouraged.

TABLE OF CONTENTS - SECTION 9

SECTION 9 - OPEN CHANNEL FLOW

- 9.1 General
- 9.2 Design Criteria
 - 9.2.1 Channel Discharge - Manning's Equation
 - 9.2.2 Channel Cross Sections
- 9.3 Channel Drop
- 9.4 Baffle Chutes
- 9.5 Structural Aesthetics
- 9.6 Computation Format
- 9.7 Channel Lining Design
 - 9.7.1 Unlined Channels
 - 9.7.2 Temporary Linings
 - 9.7.3 Grass Linings
 - 9.7.4 Rock Riprap
- 9.8 Design of Granular Filter Blanket
- 9.9 Concrete
- 9.10 Open Channel Analysis Software
 - 9.10.1 HEC-RAS

SECTION 9 - OPEN CHANNEL FLOW

9.1 GENERAL

Open channels for use in the major drainage system have significant advantages in regard to cost, capacity, multiple use for recreational and aesthetic purposes, and potential for detention storage. Disadvantages include right-of-way needs and maintenance costs. Careful planning and design are needed to minimize the disadvantages and increase the benefits.

Open channels may be used in lieu of storm sewers to convey storm runoff where:

- (1) Sufficient right-of-way is available
- (2) Sufficient cover for storm sewers is not available
- (3) It is important to maintain compatibility with existing or proposed developments
- (4) Economy of construction can be shown without long-term public maintenance expenditures

Intermittent alternating reaches of opened and closed systems should be avoided. Closed systems are preferred due to the inherent hazard of open channels in urban areas and the tendency for trash to collect in open channels.

The ideal channel is a natural one carved by nature over a long period of time. The benefits of such a channel are:

- (1) Velocities are usually low, resulting in longer concentration times and lower downstream peak flows.
- (2) Channel storage tends to decrease peak flows.
- (3) Maintenance needs are usually low because the channel is somewhat stabilized.
- (4) The channel provides a desirable green belt and recreational area, adding significant social benefits.

Generally speaking, the natural channel or the man-made channel that most nearly conforms to the character of the natural channel is the most efficient and desirable.

In many areas facing urbanization, the runoff has been so minimal that natural channels do not exist. However, a small trickle path nearly always exists that provides an excellent basis for location and construction of channels. Good land planning should reflect even these minimal trickle channels to reduce development cost and minimize drainage problems. In most cases, the prudent utilization of natural water routes in the development of the major drainage system will reduce the requirements for an underground storm sewer system.

Channel stability is a well-recognized problem in urban hydrology because of the significant increases in low flows and peak storm runoff flows. A natural channel must be studied to determine the measures needed to avoid future bottom scour and bank cutting. Erosion control measures can be taken at a reasonable cost that will preserve the natural appearance without sacrificing hydrologic efficiency. This also helps reduce public cost and channel maintenance in the future.

Sufficient right-of-way or permanent easement should be provided adjacent to open channels to allow entry of City maintenance vehicles.

9.2 DESIGN CRITERIA

Open channels shall be designed to the following criteria:

- (1) Open channels may be approved where needed to intercept runoff from an undeveloped area or from an area discharging sheet flow so that water does not wash across lots in an uncontrolled manner. Such channels shall be designed on a 50-year storm. In all cases for open channels, the Design Engineer shall calculate the 100-year flow and show the 100-year flow boundary and elevation on the plat.
- (2) Channel or adjacent public drainage easement, floodway, etc., shall be capable of carrying the 100-year storm. Adjacent public drainage easements shall contain the width of flow of channel, floodway, floodplain, etc., plus an additional 15' on one side of the defined design top of bank or as approved by the City Staff.

9.2.1 CHANNEL DISCHARGE - MANNING'S EQUATION

Careful attention must be given to the design of drainage channels to assure adequate capacity and minimum maintenance to overcome the results of vegetative growth, erosion, and silting. The hydraulic characteristics of channels shall be determined by Manning's Equation:

$$Q = \frac{1.49}{n} AR^{2/3} S^{1/2}$$

Where,

Q = Total discharge in CFS

n = Coefficient of roughness

A = Cross-sectional area of channel (square feet)

R = Hydrologic radius of channel (feet)

S = Slope of channel (feet per foot)

For a given channel condition of roughness, discharge, and slope, there is only one possible depth for maintaining a uniform flow. This depth is the normal depth. When roughness, depth, and slope are known at a channel section, there can only be one discharge for maintaining a uniform flow through the section. This discharge is the normal discharge.

If the channel is uniform in resistance and gravity forces are in exact balance, the water surface will be parallel to the bottom of the channel. This is the condition of uniform flow.

Uniform flow is more often a theoretical abstraction than an actuality. True uniform flow is difficult to find in the field or to obtain in the laboratory. Channels are sometimes designed on the assumption that they will carry uniform flow at the normal depth. However, the flow will actually have depths considerably different from uniform depth because of conditions difficult-if not impossible-to evaluate and hence not taken into account. The Engineer must be aware of the fact that although uniform flow computation provides only an approximation of what will occur, such computations are useful and necessary for planning.

The normal depth is computed so frequently in trapezoidal channels that it is convenient to use nomographs for such types of cross sections to eliminate the need for time-consuming trial-and-error solutions. A nomograph for uniform flow is given in Figure 9.1.

Open channel flow in urban drainage systems is usually non-uniform because of bridge openings, curbs, and structures. This necessitates the use of backwater computations for all final channel design work.

A water surface profile must be computed for all channels and shown on all final drawings. Computation of the water surface profile should utilize standard backwater methods or acceptable computer routines, taking into

consideration all losses due to the changes in velocity, drops, bridge openings, and other obstructions.

Channels should have sections of adequate cross-sectional areas to take care of uncertainties in runoff estimates, changes in channel coefficients, channel obstructions, and silt accumulations.

Accurate determination of the "n" value is critical in the analysis of a channel's hydraulic characteristics. The "n" value of each channel reach should be based on experience and judgment with regard to the individual channel characteristics. Table 9.1 gives a method of determining the composite roughness coefficient based on actual channel conditions.

Where practical, unlined channels should have sufficient gradient, depending upon the type of soil, to provide velocities that will be self cleaning but will not so great as to create erosion. Lined channels, drop structures, check dams, or concrete spillways may be required to control erosion that results from the high velocities of large volumes of water. Unless approved otherwise by the City Staff, channel velocities in man-made channels shall not exceed those specified in Table 4.2.

Where velocities exceed specified velocities, riprap, pavement, or other approved protective erosion protection shall be required. As minimum protection to reduce erosion, all open channels slopes shall be seeded or sodded as soon after grading as possible.

9.2.2 CHANNEL CROSS SECTIONS

The channel shape may be almost any type suitable to the location and to the environmental conditions. Often the shape can be chosen to suit open space and recreational needs and to create additional benefits.

(1) Side Slope

Except in horizontal curves, the flatter the side slope, the better. Normally, slopes shall be no steeper than 3:1, which is also the practical limit for mowing equipment. Rock or concrete-lined channels or those that for other reasons do not require slope maintenance may have slopes as steep as 1-1/2:1, or designed in rectangular form if walls are structurally designed.

(2) Depth

Deep channels are difficult to maintain and can be hazardous. Constructed channels should therefore be as shallow as practical.

(3) Bottom Width

Channels with narrow bottoms are difficult to maintain and are conducive to high velocities during high flows. It is desirable to design open channels so that the bottom width is at least twice the depth.

(4) Bend Radius

The minimum bend radius required for open channels is 25' or 10 times the bottom width whichever is larger.

(5) Trickle Channels

The low flows, and sometimes base flows, from urban areas must be given specific attention. If erosion of the bottom of the channel appears to be a problem, low flows shall be carried in a paved trickle channel that has a capacity of 5.0 percent of the design peak flow. Care must be taken to ensure that low flows enter the trickle channel without the attendant problem of the flow paralleling the trickle channel.

(6) Freeboard

Freeboard height should be chosen to provide a suitable safety margin. The height of freeboard shall be the greater of: 1) 1' for velocities up to 8 fps, 2) 2' minimum for velocities over 8 fps, or 3) provide additional height as calculated by Equation 9.1.

$$\text{Freeboard (in feet)} = 1.0 + 0.025 V(D)^{1/3} \quad (9.1)$$

Where,

V = Velocity of flow (fps)

D = Depth of flow (feet)

For the freeboard of a channel on a sharp curve, extra height must be added to the outside bank or wall in the amount:

$$H = \frac{V^2 (T + B)}{2gR} \quad (9.2)$$

Where,

H = Additional height on outside edge of channel (feet)

V = Velocity of flow in channel (fps)

T = Width of flow at water surface (feet)

B = Bottom width of channel (feet)

R = Centerline radius of turn (feet)

g = Acceleration of gravity (32.2 fps²)

If R is equal to or greater than 3 x B, additional freeboard is not required.

(7) Connections

Connections at the junction of two or more open channels shall be smooth. Pipe and box culvert or sewers entering an open channel will not be permitted to project into the normal channel section, nor will they be permitted to enter an open channel at an angle that would direct flow from the culvert or sewer upstream in the channel.

9.3 CHANNEL DROPS

The use of channel drops permits adjustment of channel gradients that are too steep for the design conditions. In urban drainage work, it is often desirable to use several low-head drops in lieu of a few higher drops.

The use of sloped drops will generally result in lower installation cost. Sloped drops can easily be designed to fit the channel topography.

Sloped drops shall have roughened faces and shall be no steeper than 2:1. They shall be adequately protected from scour and shall not cause an upstream water surface drop that will result in high velocities upstream. The design should offer protection against side cutting just downstream from the drop, which is a common problem.

The length of the drop (L) will depend upon the hydraulic characteristics of the channel and drop. For a Q of 30 cubic feet per second/ft, L would be about 15', that is, about 1/2 of the Q value. The L should not be less than 10', even for low Q values. In addition, follow-up riprapping will often be necessary at most drops to more fully protect the banks and channel bottom. The criteria given are minimal, based on the philosophy that it is less costly to initially under-protect with riprap and to place additional protection after erosional tendencies are determined in the field. Project approvals are to be based on provisions for such follow-up construction.

9.4 BAFFLE CHUTES

Baffle chutes are used to dissipate the energy in the flow at a larger drop. They require no tail water to be effective. They are particularly useful where the water surface upstream is held at a higher elevation to provide head for filling a side storage pond during peak flows.

Baffle chutes are used in channels where water is to be lowered from one level to another. The baffle piers prevent undue acceleration of the flow as it passes down the chute. Since the flow velocities entering the downstream channel are low, no stilling basin is needed. The chute, on a 2:1 slope or flatter, may be designed to discharge up to 60 CFS per linear foot of width, and the drop may be as high as structurally feasible. The lower end of the chute is constructed to below streambed level and backfilled as necessary. Degradation of the streambed does not, therefore, adversely affect the performance of the structure. In urban drainage design, the lower end should be protected from the scouring action.

The baffled apron shall be designed for the full discharge design flow. Baffle chutes shall be designed using acceptable methods such as those presented by A.S. Peterka of the United States Bureau of Reclamation and Engineering Nomograph No. 25.

9.5 STRUCTURAL AESTHETICS

The use of hydrologic structures in the urban environment requires an approach not encountered elsewhere in the design of such structures. The appearance of these structures is very important. The treatment of the exterior should not be considered of minor importance. Appearance must be an integral part of the design.

Parks. It must be remembered that structures are often the only above-ground indication of the underground works involved in an expensive project. Furthermore, parks and green belts may later be developed in the area in which the structure will play a dominant environmental role.

Play Areas: An additional consideration is that the drainage structures offer excellent opportunities for neighborhood children to play. It is almost impossible to make drainage works inaccessible to children, and therefore, what is constructed should be made as safe as reasonably possible. Safety hazards should be minimized and vertical drops protected with decorative fencing or rails.

Concrete Surface Treatment: The use of textured concrete presents a pleasing appearance and removes form marks. Exposed aggregate concrete is also attractive but may require special control of aggregate used in the concrete and may result in unsafe slippery surface conditions.

Rails and Fences: The use of rails and fences along concrete walls provides a pleasing topping to an otherwise stark wall and also gives a degree of protection against someone inadvertently falling over the wall.

9.6 COMPUTATION FORMAT

Figure 9.2 is to be used for open channel design. The steps to follow in an open channel design are:

1. List all the design data (i.e., location, area, runoff coefficients, typical section, slope, etc.).
2. Determine the initial time of concentration (T_o).
3. Estimate travel time (T_d) through study reach and add to initial time of concentration to obtain time of concentration (T_c) at lower end of study reach.
4. Determine the discharge for the design storm using T_c .
5. Enter the discharge and slope in the appropriate channel design chart with the discharge in the slope to find the velocity and depth of flow.
6. Check the estimated travel time against the calculated velocity using Manning's Equation.
 - A. If the estimated travel time is comparable to the calculated travel time (+/- 1.0 min.), proceed to Step 7.
 - B. If the estimated travel time does not check with the calculated travel time, repeat Steps 3-6 until an agreement is reached.
7. If excessive velocities or water depths are determined, select another typical section, revise channel grade, or revise lining and repeat Steps 3-7.

8. Similar calculations are to be made to determine operational characteristics - freeboard, velocity, etc.

9.7 CHANNEL LINING DESIGN

Open channels are generally the main facility for the major drainage system (except for the roadside ditch). If the historic or natural drainage path is selected for the open channel route, the construction costs for the system can be minimized and environmental opportunities optimized. The historic route along with minimum alteration of the existing channel is recommended for all drainage ways. In some instances, however, the land use of the property can be improved by relocating or straightening the natural drainage path, thereby improving the economic aspects of the project. Altering the channel alignment and shape may require the addition of grade control sections to control the flow velocities. Grade control structures may also be required to control erosion from increased base flows due to urbanization.

9.7.1 UNLINED CHANNELS

The design charts for unlined channels (bare soils) are based on tests on 10 different classes of soils, ranging from cohesive clays to non-cohesive sands and gravels. These are Figures 9.3 and 9.4. Generally, sandy, non-cohesive soils tend to be very erodible; the large-grained gravel clay-silt mixtures are erosion resistant; and the mixtures of sand, clay, and colloids are moderately erodible.

9.7.2 TEMPORARY LININGS

Temporary linings are flexible coverings used to protect a channel until permanent vegetation can be established using seeding. For the most part, the materials used are biodegradable. Listed below are some of the temporary linings that can be used. Among the factors that should be known in order to use these are hydraulic radius, soil condition, and channel slope. When one or all of these factors are known, then a flow velocity or maximum flow depth can be determined from Figures 9.15 through 9.13.

1. *Fiber glass roving
2. *Jute matting
3. *Wood fiber

* Refer to the Arkansas Highway and Transportation Department's Standard Specifications for material descriptions and construction methods.

9.7.3 GRASS LINING

Several different types of vegetative covers are listed and grouped according to degree of retardance in Table 9.2. This table can be used in conjunction with AHTD seeding specifications. Figures 9.14 through 9.21 determine flow velocities or maximum flow depths given such factors as channel slope, hydraulic radius, and/or soil types. Table 9.3 is a relatively good source for checking permissible velocities for different types of grass linings in channels.

9.7.4 ROCK RIPRAP (to be used by Special Approval only)

The resistance of random riprap to displacement by moving water depends upon:

1. Weight, size, shape, and composition of the individual stones
2. The gradation of the stone
3. The depth of water over the stone blanket
4. The steepness and stability of the protected slope and angle of repose of riprap
5. The stability and effectiveness of the filter blanket on which the stone is placed
6. The protection of toe and terminals of the stone blanket

The size of stone needed to protect a stream bank or highway embankment from erosion by a current moving parallel to the embankment is determined by the use of Figures 9.22, 9.23 and 9.24.

When rock riprap is used, the need for an underlying filter material must be evaluated. The filter material may be either a granular blanket or plastic filter cloth.

9.8 DESIGN OF GRANULAR FILTER BLANKET

For a granular filter blanket, the following criteria should be met:

$$\frac{D_{15} \text{ Filter}}{D_{85} \text{ Base}} < 5 < \frac{D_{15} \text{ Filter}}{D_{15} \text{ Base}} < 40$$

and

$$\frac{D_{50} \text{ Filter}}{D_{50} \text{ Base}} < 40$$

D = Grain diameter (mm)

% = Percent finer (e.g., D₁₅, D₅₀, and D₈₅ are the diameters corresponding to percents finer than 15%, 50%, and 85%).

In the preceding relationships, filter refers to the overlying material. The relationships must hold between the filter blanket and base material and the riprap and filter blanket.

9.9 CONCRETE

Concrete-lined channels provide high capacities, but also have high outlet velocities, so erosion problems become evident and must be dealt with. Since no scour occurs in rigid linings for the velocities normally encountered in drainage design, no curves are necessary. Capacity Figures 9.25 through 9.36 relate velocity and discharge to the channel geometry, slope, and resistance. Manning's Equation may be solved through trial and error by using the trapezoidal channel charts.

9.10 OPEN CHANNEL ANALYSIS SOFTWARE

To aid in the analysis and design of open channels, the City will allow the use of HEC-RAS or an acceptable equal approved by the City. The use of computerized methods by experienced engineers is encouraged.

9.10.1 HEC-RAS

HEC-RAS is the successor program to the Corps of Engineers' well-known HEC-2 program. HEC-RAS builds upon the basic computational capabilities of HEC-2, which included calculating water surface profiles for steady, gradually varied flow in natural or man-made channels. Both sub-critical and supercritical flow profiles can be calculated. The effects of obstructions such as bridges, culverts, weirs, and structures in the floodplain may also be considered.

For an in-depth discussion of the program's capabilities and limitations refer to the HEC-RAS website at **<http://www.hec.usace.army.mil/software/hec-ras/hecras-hecras.html>**.

TABLE 9.1

COMPUTATION OF COMPOSITE ROUGHNESS COEFFICIENT
FOR EXCAVATED AND NATURAL CHANNELS

$$n = (n_0 + n_1 + n_2 + n_3 + n_4) m$$

	<u>CHANNEL CONDITIONS</u>	<u>VALUE</u>
Material Involved n_0	Earth	0.020
	Rockcut	0.025
	Final Gravel	0.024
	Coarse Gravel	0.028
Degree of Irregularity n_1	Smooth	0.000
	Minor	0.005
	Moderate	0.010
	Severe	0.020
Variation of Channel Cross Section n_2	Gradual	0.000
	Alternating Occasionally	0.005
	Alternating Frequently	0.010-0.015
Relative Effect Of Obstructions n_3	Negligible	0.000
	Minor	0.010-0.015
	Appreciable	0.020-0.030
	Severe	0.040-0.060
Vegetation n_4	Low	0.005-0.010
	Medium	0.010-0.025
	High	0.025-0.050
	Very High	0.050-0.100
Degree of Meandering m	Minor	1.000-1.200
	Appreciable	1.200-1.500
	Severe	1.500

Roughness Coefficient For Lined Channels

Concrete Lined - $n = 0.017$

Rubble RipRap - $n = 0.022$

Open Channel Hydraulics
Ven Te Chow, PhD

COMPUTATION OF COMPOSITE ROUGHNESS COEFFICIENT
FOR EXCAVATED AND NATURAL CHANNELS

Table 9.1

PERMISSIBLE VELOCITIES FOR CHANNELS LINED WITH GRASS*

Cover	Slope range, %	Permissible velocity, fps	
		Erosion-resistant soils	Easily eroded soils
Bermuda grass	0-5	8	6
	5-10	7	5
	>10	6	4
Buffalo grass, Kentucky bluegrass, smooth brome, blue grama	0-5	7	5
	5-10	6	4
	>10	5	3
Grass mixture	0-5	5	4
	5-10	4	3
Do not use on slopes steeper than 10%			
Lespedeza sericea, weeping love grass, ischaemum (yellow blue- stem), kudzu, alfalfa, crabgrass	0-5	3.5	2.5
	Do not use on slopes steeper than 5%; except for side slopes in a combinatuon channel		
Annuals—used on mild slopes or as temporary protection until per- manent covers are established, common lespedeza, Sudan grass	0-5	3.5	2.5
	Use on slopes steeper than 5% is not recommended		

REMARKS. The values apply to average, uniform stands of each type of cover. Use velocities exceeding 5 fps only where good covers and proper maintenance can be obtained.

SOURCE:
City of
SPRINGDALE
Arkansas

Table 9.3

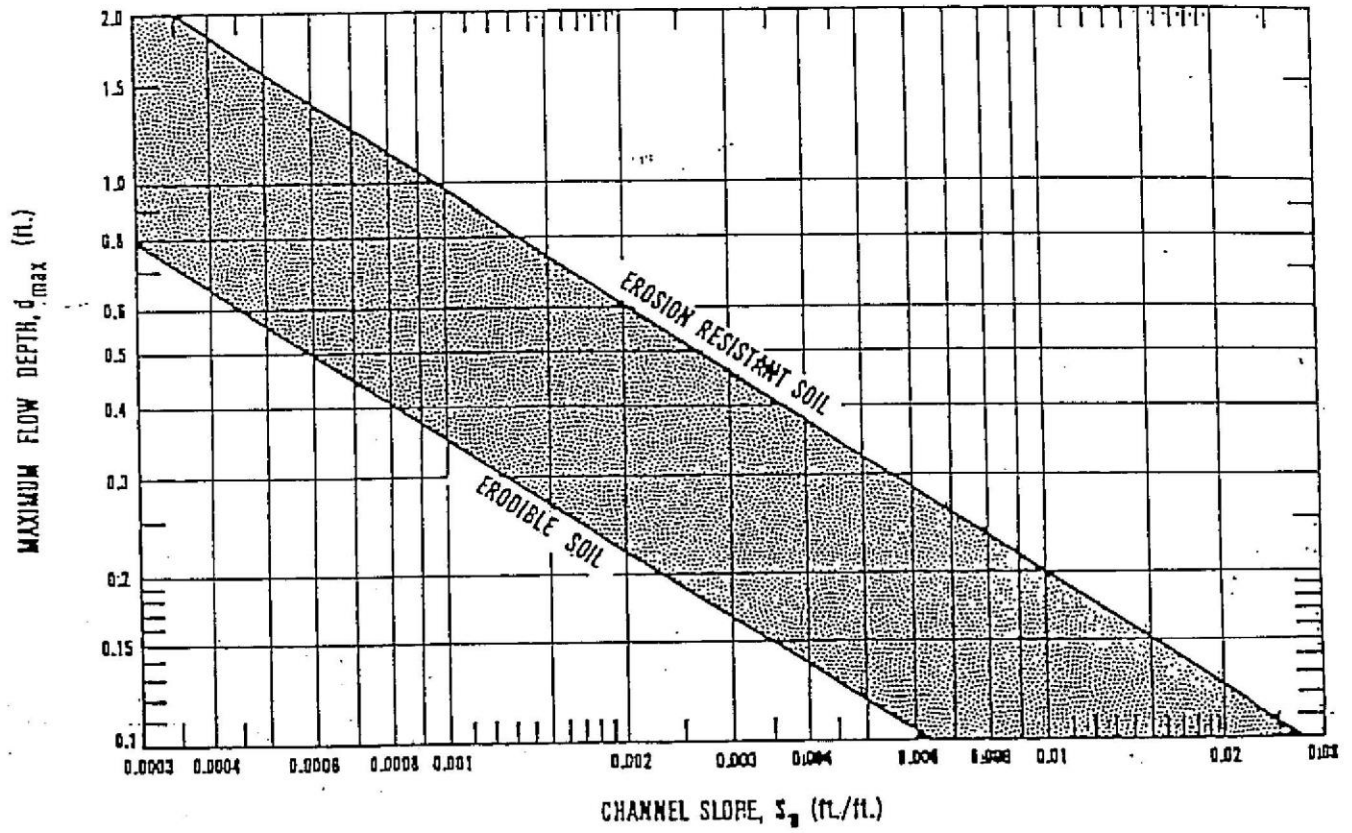

Source:
City of
SPRINGDALE
Arkansas

MAXIMUM PERMISSIBLE DEPTH OF FLOW (d_{max} .) FOR
UNLINED CHANNELS (BARE SOIL)

Figure 9.4

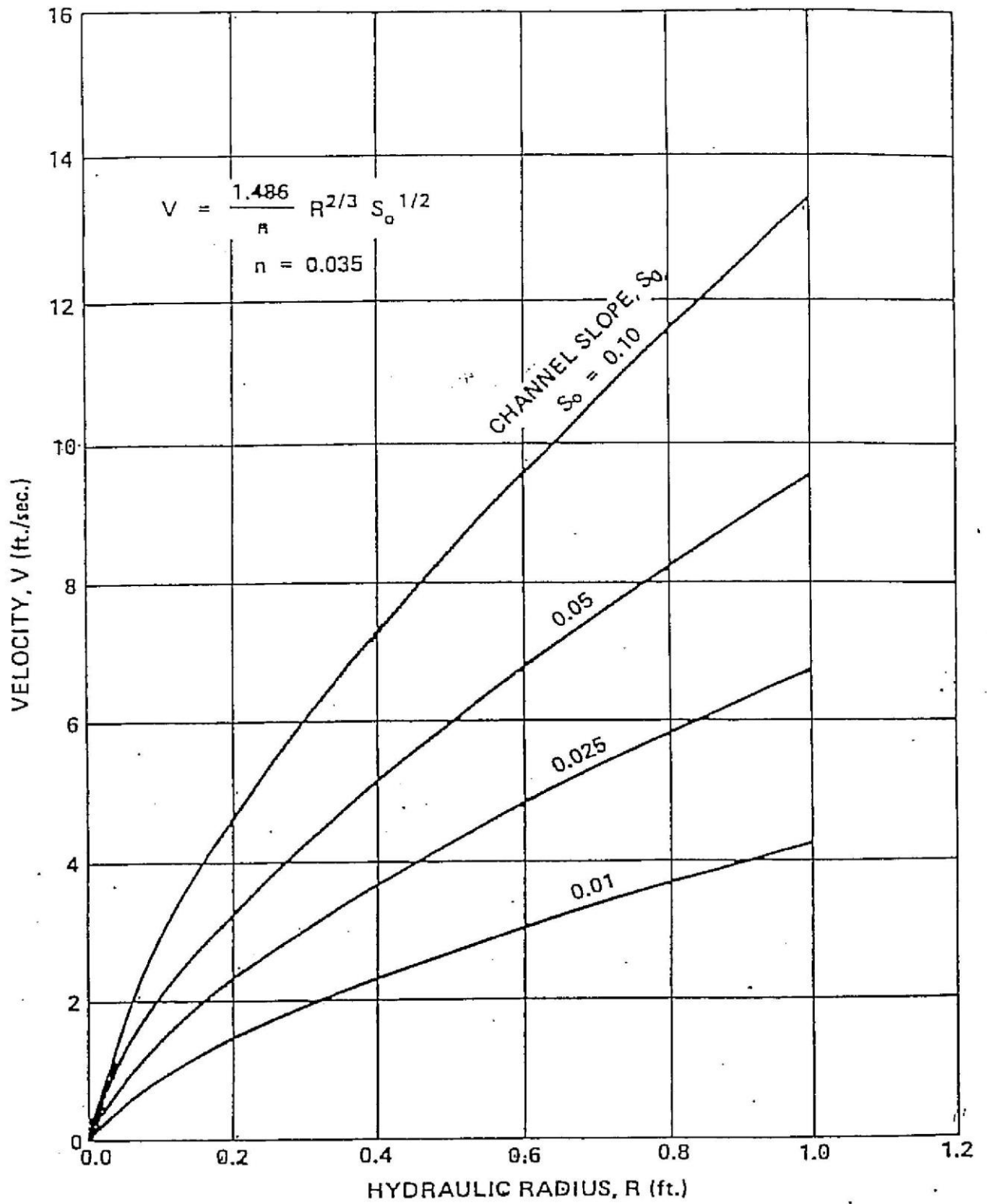

SOURCE:
 City of
 SPRINGDALE
 Arkansas

FLOW VELOCITY FOR CHANNELS LINED WITH
 FIBER GLASS ROVING TACKED WITH ASPHALT
 SINGLE LAYER

Figure 9.6

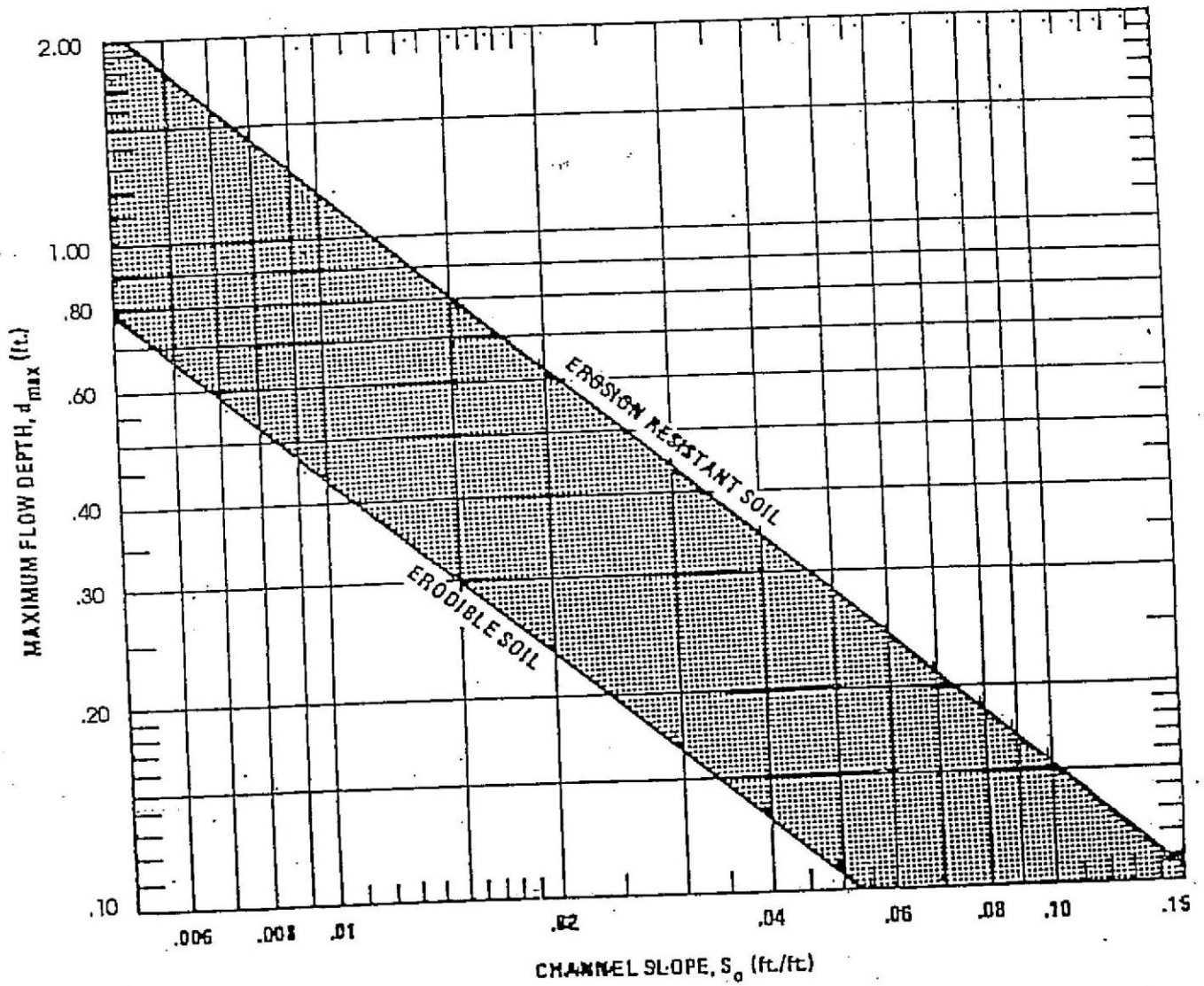

Source:
City of
SPRINGDALE
Arkansas

MAXIMUM PERMISSIBLE DEPTH OF FLOW (d_{max})
FOR CHANNELS LINED WITH JUTE MESH

Figure 6

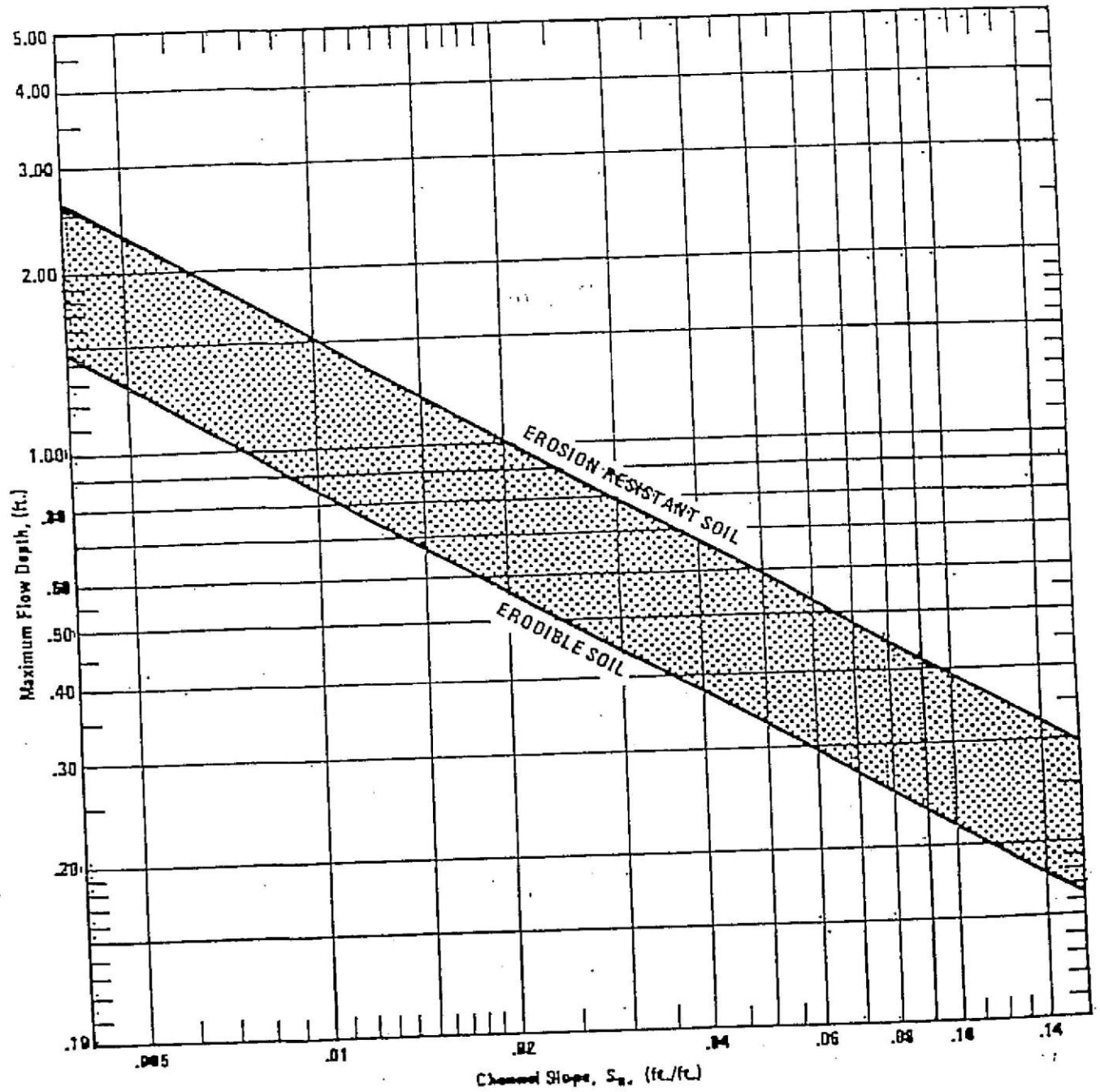

Source:
City of
SPRINGDALE
Arkansas

MAXIMUM PERMISSIBLE DEPTH OF FLOW (d_{max}) FOR
CHANNELS LINED WITH EXCELSIOR MAT

Figure 9.10

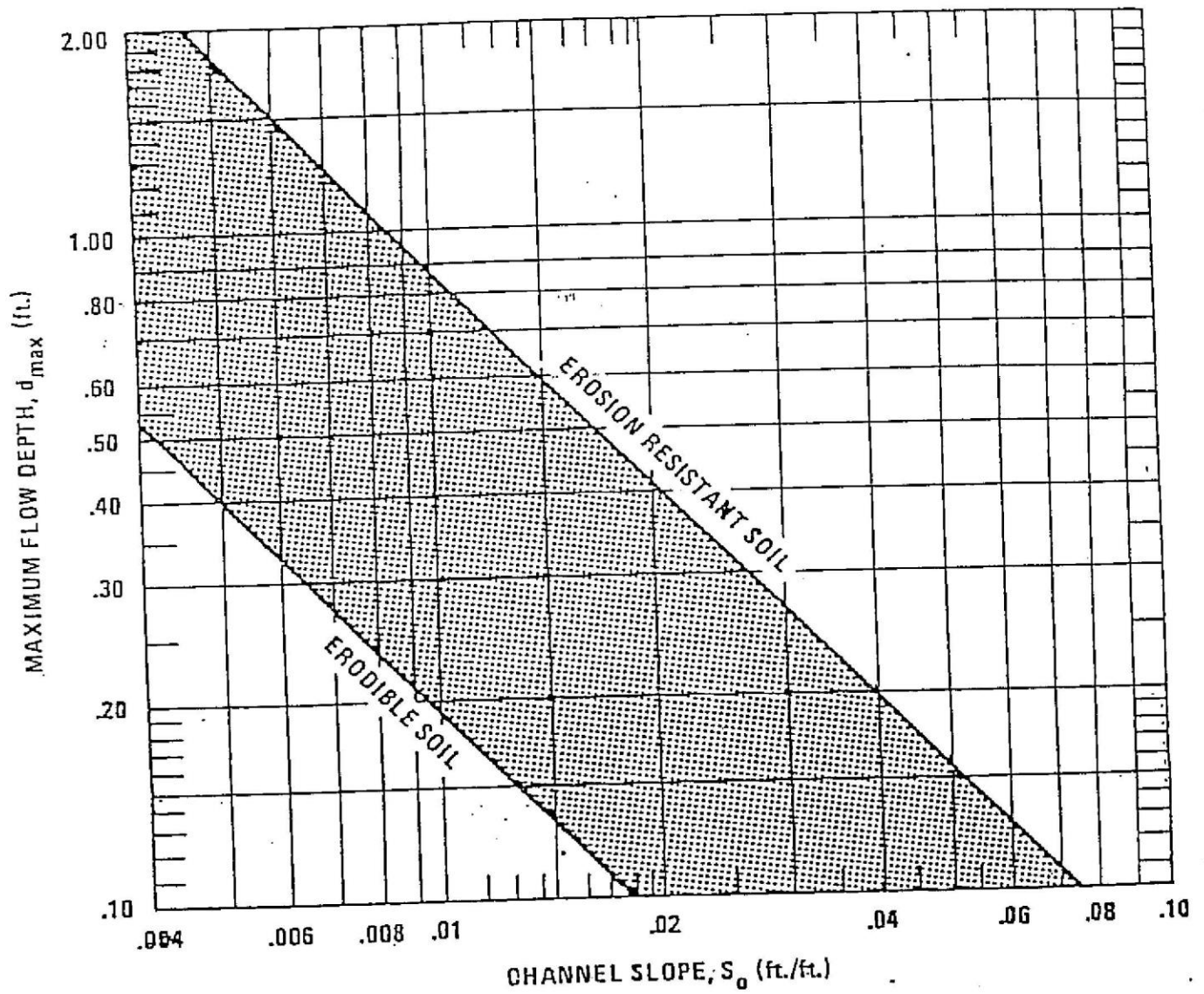

Source:
City of
SPRINGDALE
Arkansas

MAXIMUM PERMISSIBLE DEPTH OF FLOW (d_{max}) FOR
CHANNELS LINED WITH EROSIONET

Figure 9.12

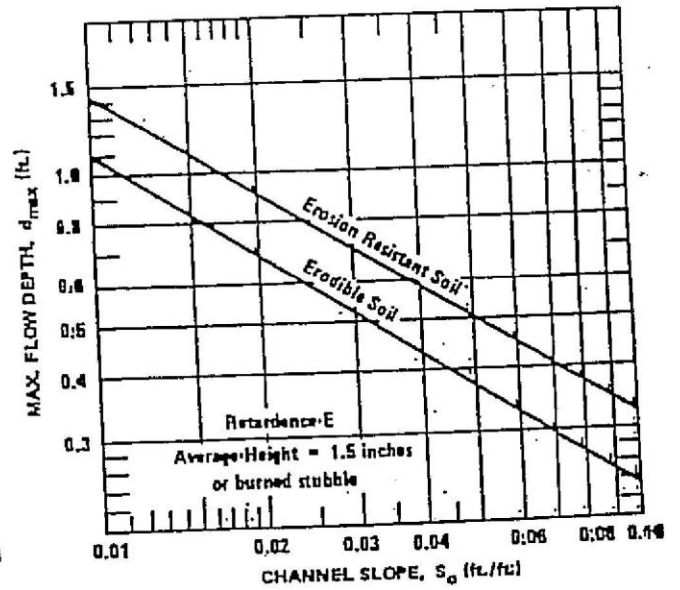
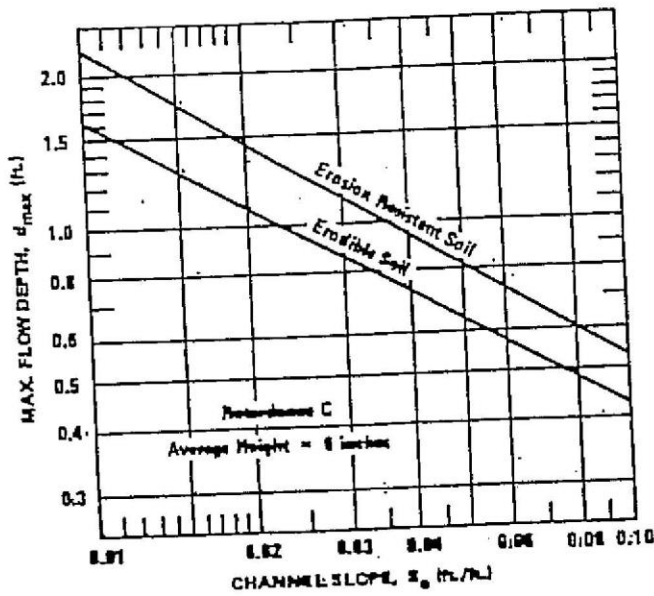
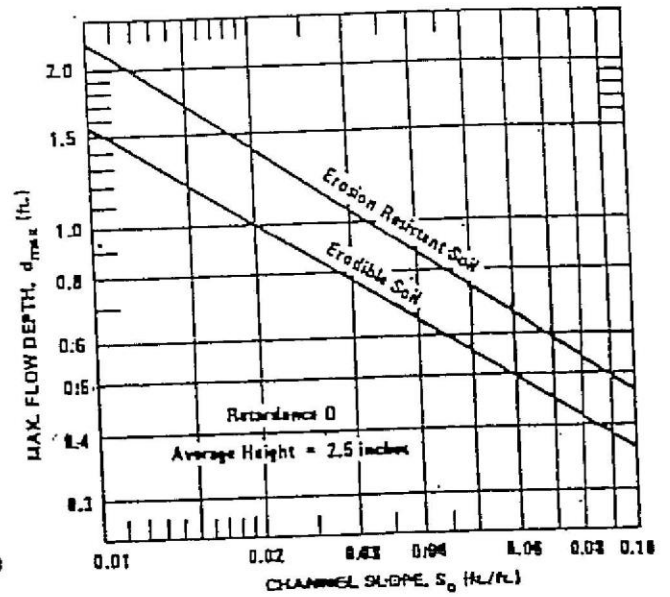
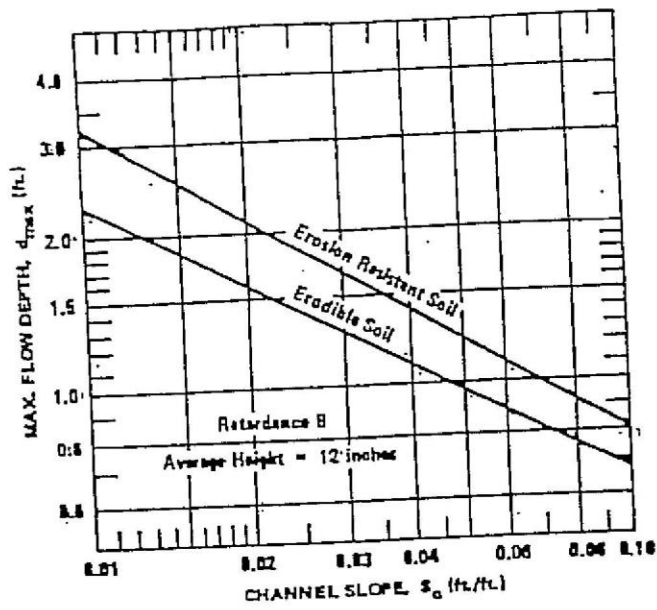

NOTE: Use on slopes greater than 10% is not recommended

SOURCE:
City of
SPRINGDALE
Arkansas

MAXIMUM PERMISSIBLE DEPTH OF FLOW (d_{max}) FOR
CHANNELS LINED WITH BERMUDA GRASS.
GOOD STAND, CUT TO VARIOUS LENGTHS

Figure 5

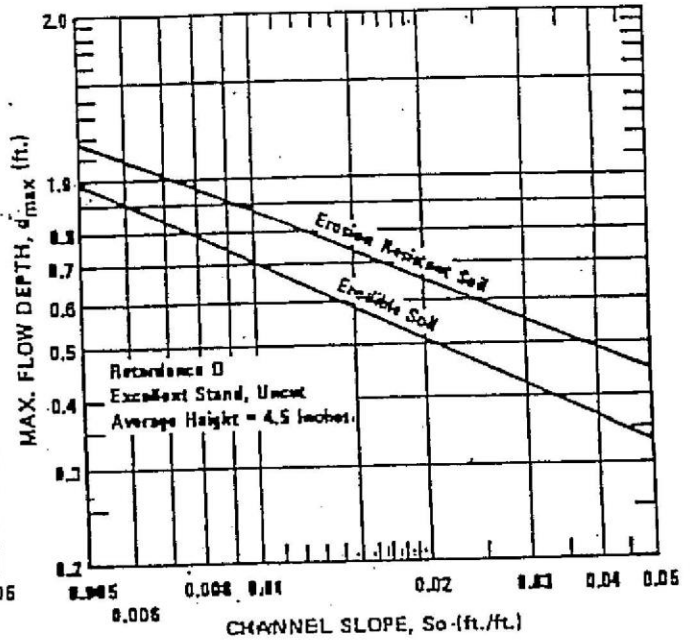
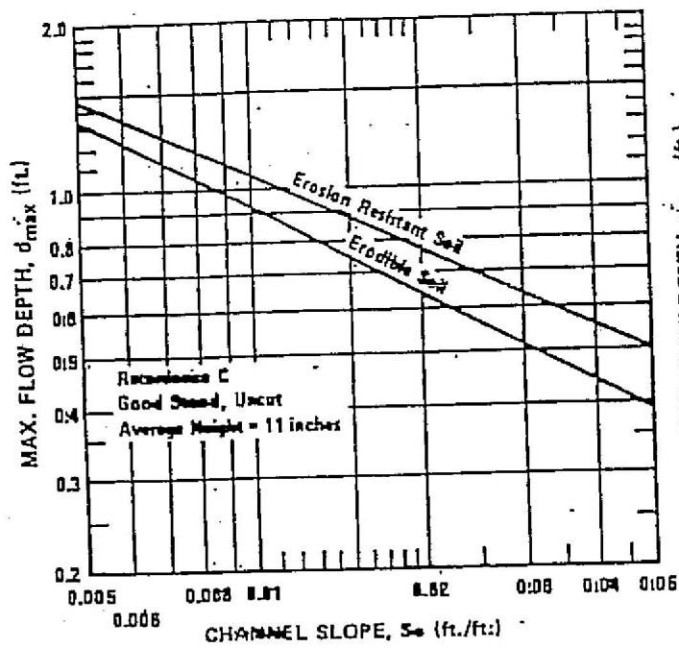

SOURCE:
City of
SPRINGDALE
Arkansas

MAXIMUM PERMISSIBLE DEPTH OF FLOW (d_{max}) FOR
CHANNELS LINED WITH COMMON LESPEDEZA OF
VARIOUS LENGTHS

Figure 9.16

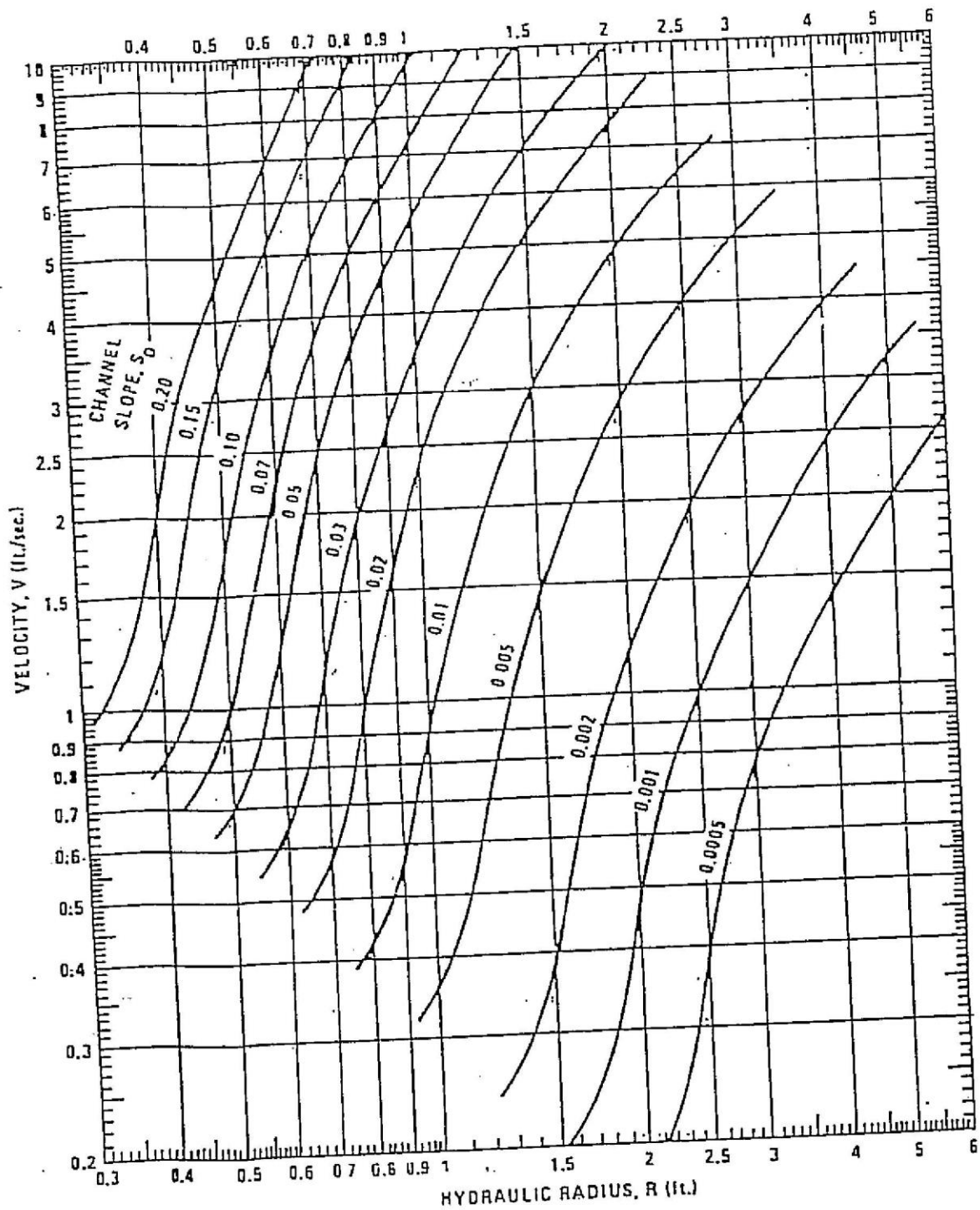

SOURCE:
City of
SPRINGDALE
Arkansas

Flow Velocity for Channels Lined with
Vegetation of Retardance B

Figure 9.18

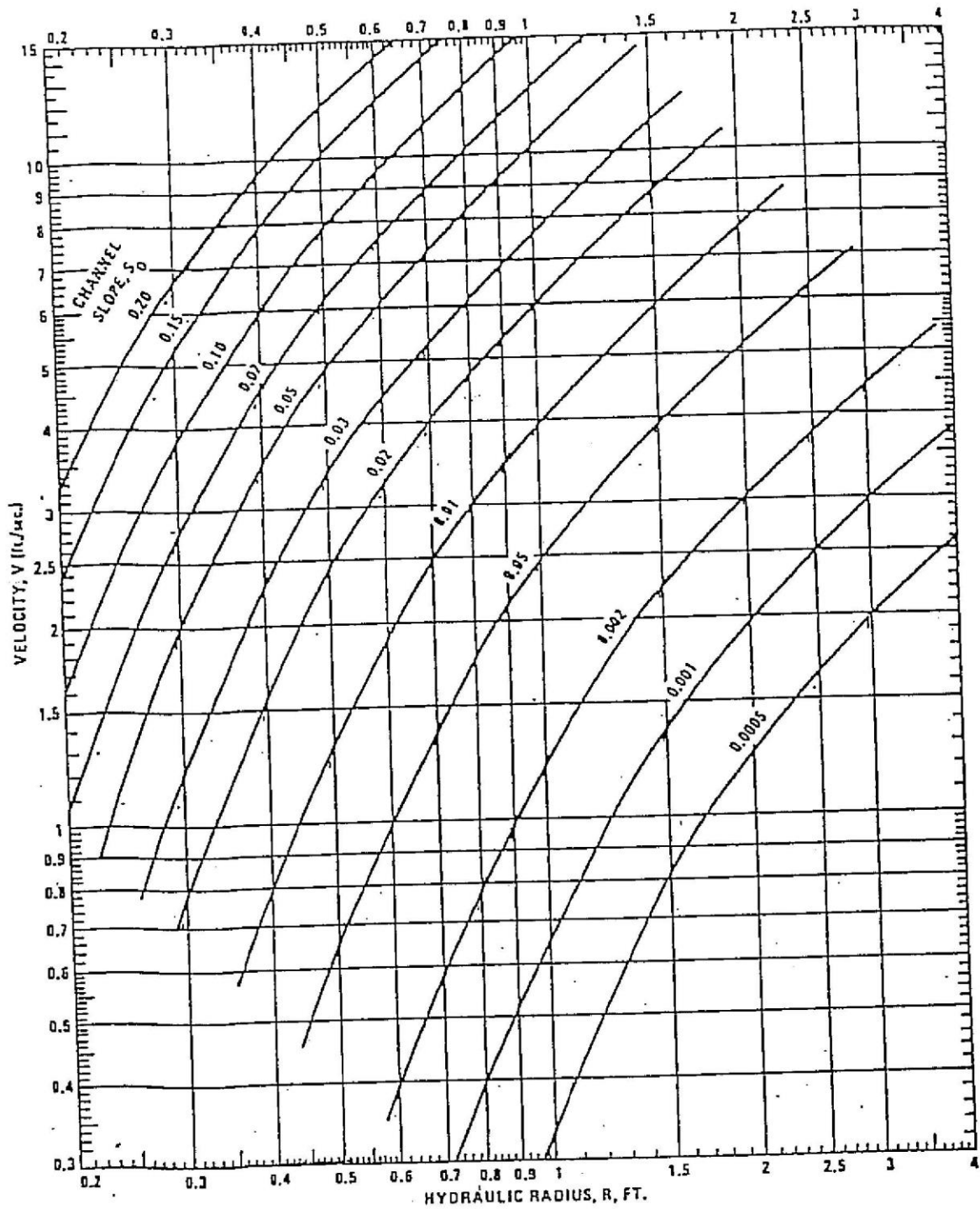

SOURCE:
City of
SPRINGDALE
Arkansas

Flow Velocity for Channels Lined with
Vegetation of Retardance D

Figure 9.20

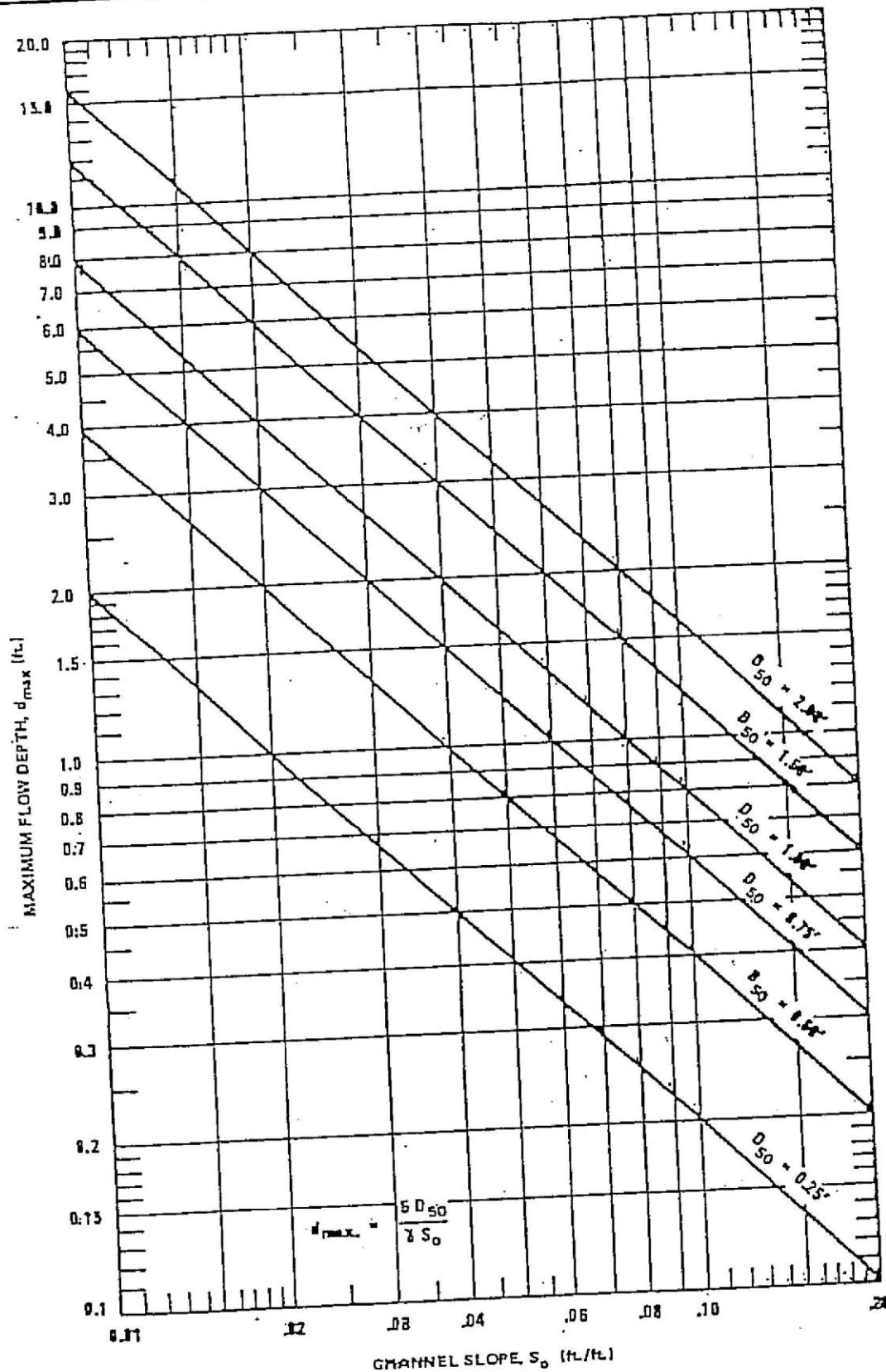

SOURCE:
City of
SPRINGDALE
Arkansas

Maximum Permissible Depth of Flow ($d_{max.}$)
For Channels Lined with Rock Riprap

Figure 9.22

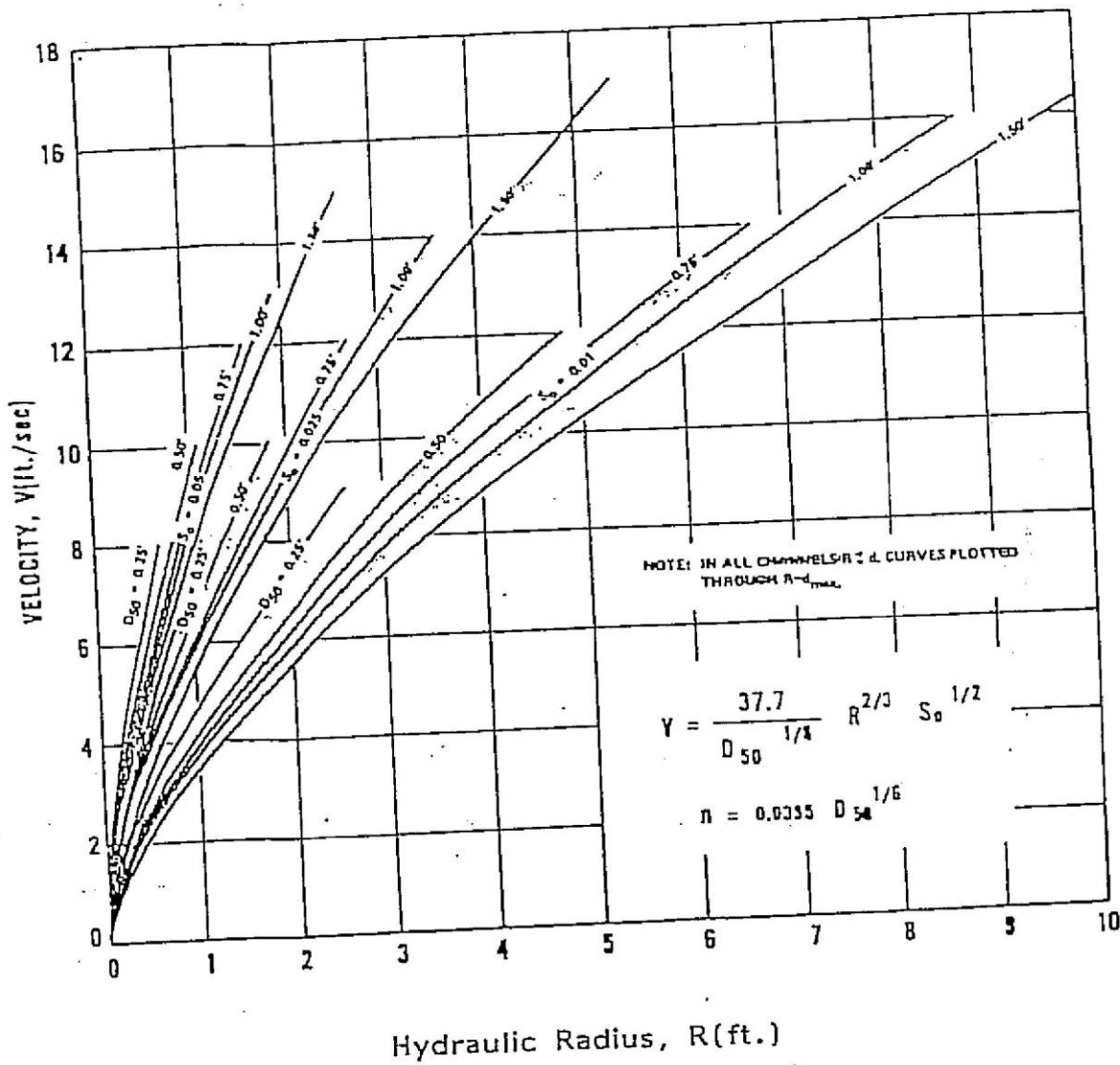

SOURCE:
City of
SPRINGDALE
Arkansas

FLOW VELOCITY FOR CHANNELS LINED WITH ROCK RIPRAP
SLOPES = 0.01 TO 0.05, D₅₀ = 0.25' TO 1.50'

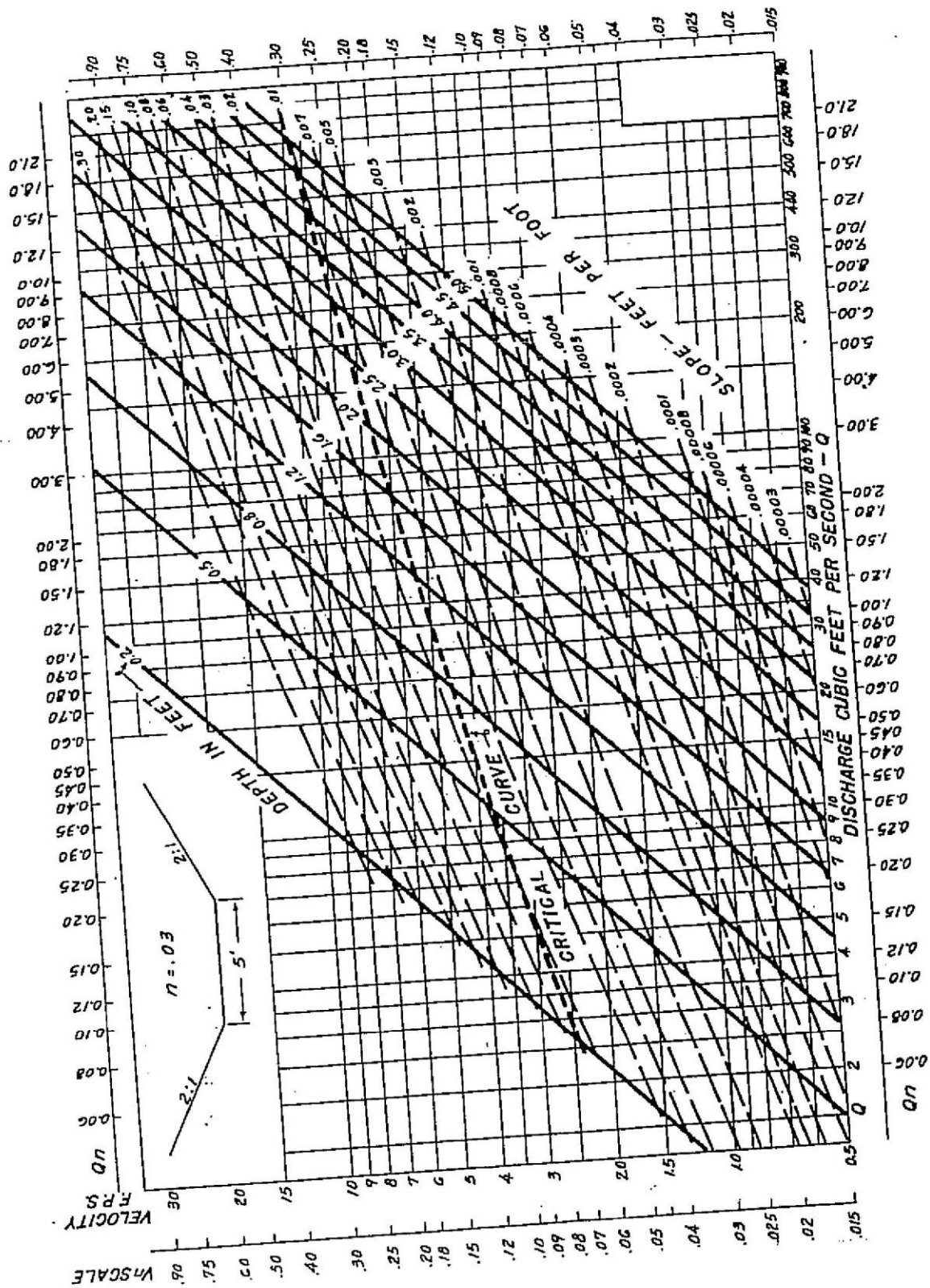

SOURCE:
City of
SPRINGDALE
Arkansas

CHANNEL CHART
2:1 b = 5 Ft.

Figure 9.2

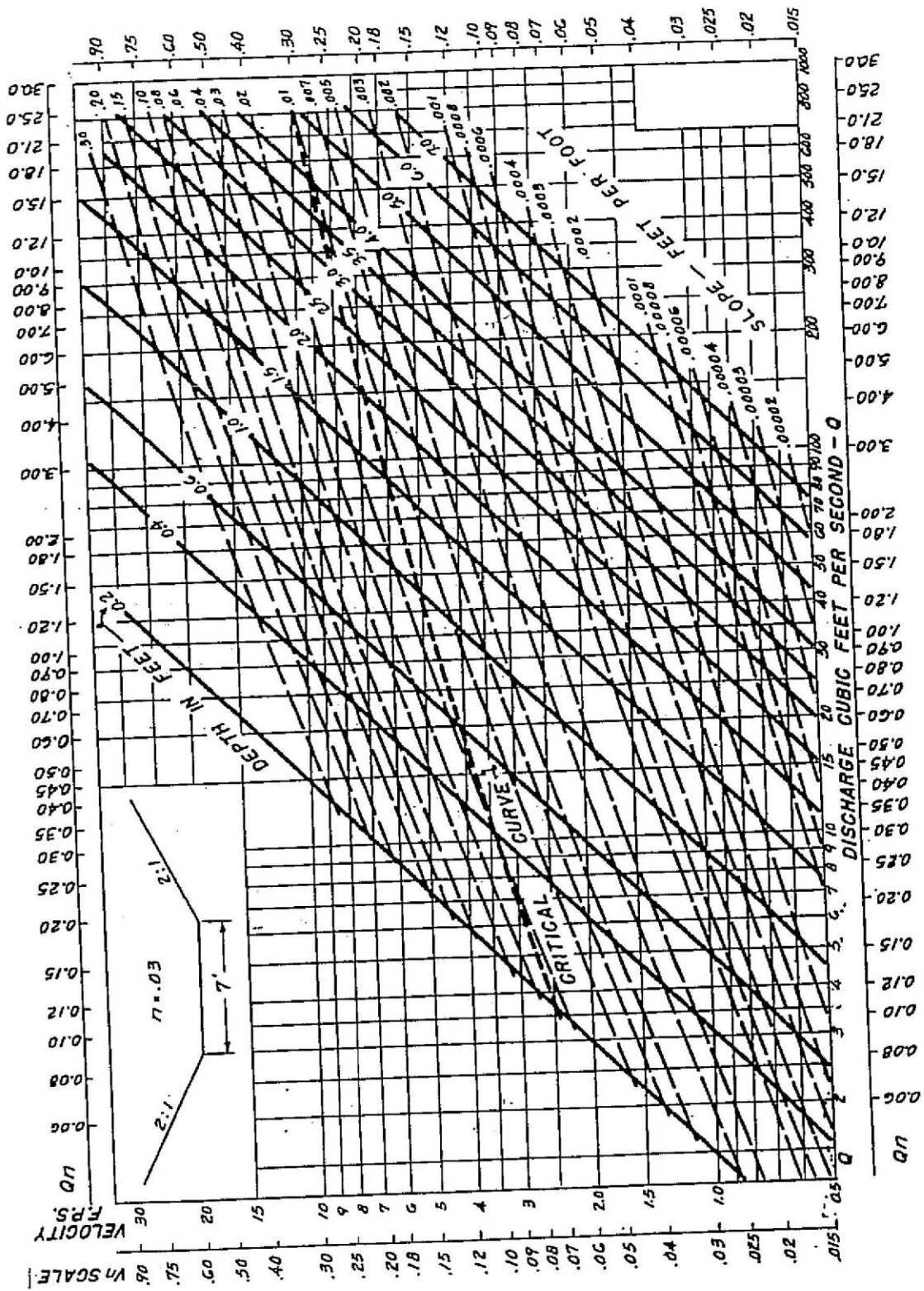

Source:
City of
SPRINGDALE
Arkansas

CHANNEL CHART
2:1 b = 7 Ft.

Figure 9.28

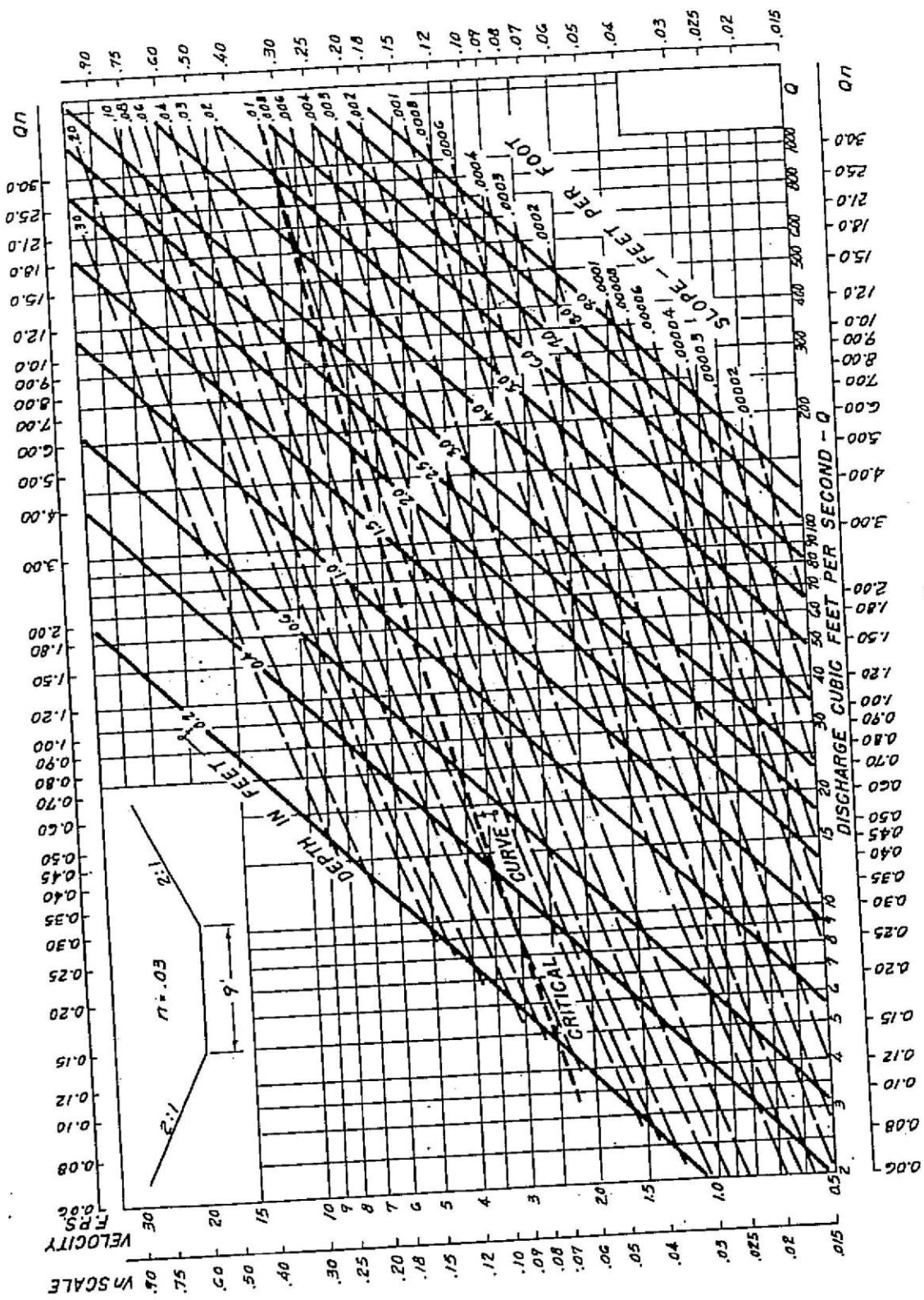

SOURCE:
City of
SPRINGDALE
Arkansas

CHANNEL CHART
2:1 b = 9 ft.

Figure 9.30

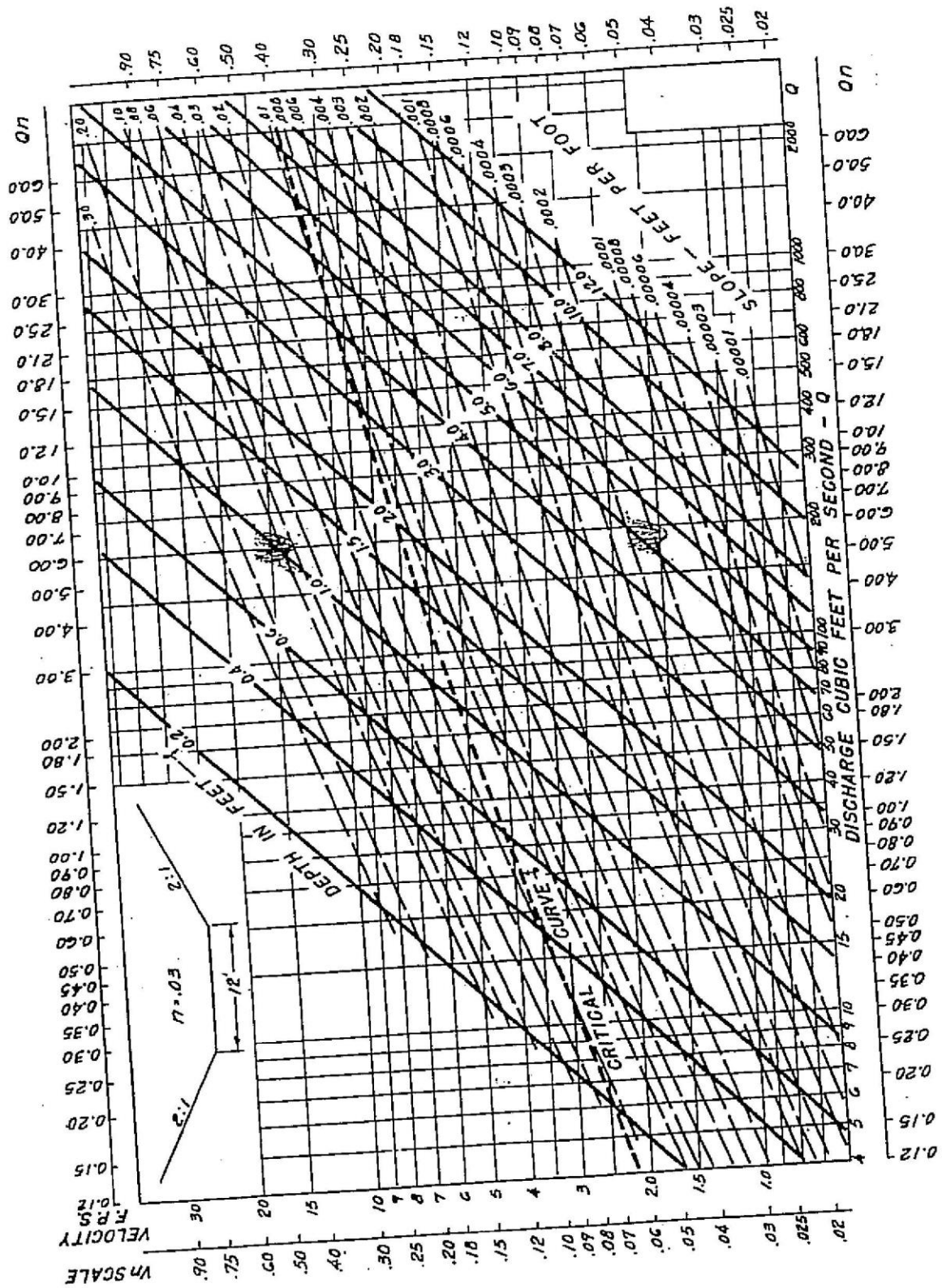

SOURCE:
City of
SPRINGDALE
Arkansas

CHANNEL CHART
2:1 b = 12 Ft.

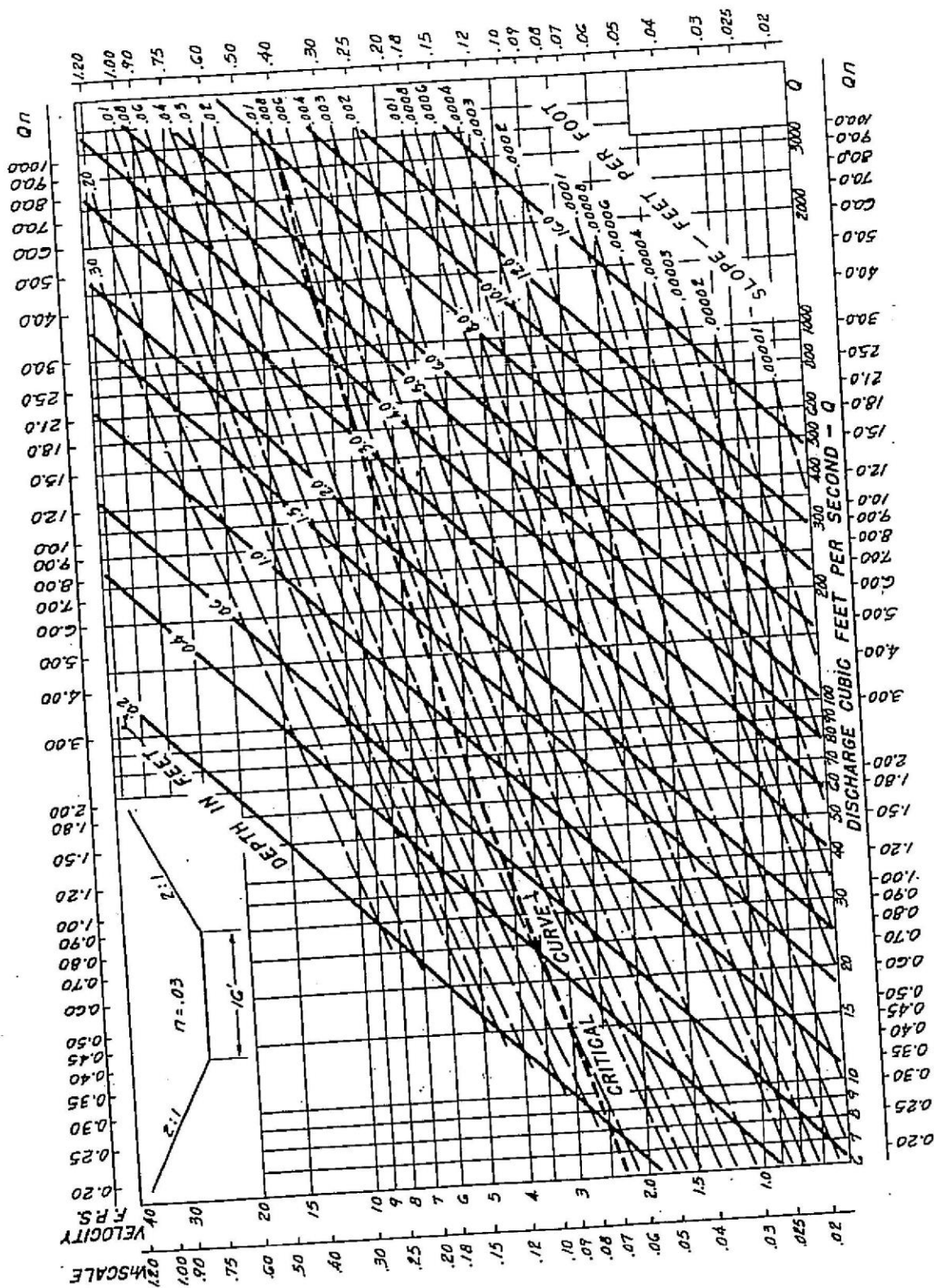

SOURCE:
City of
SPRINGDALE
Arkansas

CHANNEL CHART
2:1 b = 16 Ft.

Figure 9.3

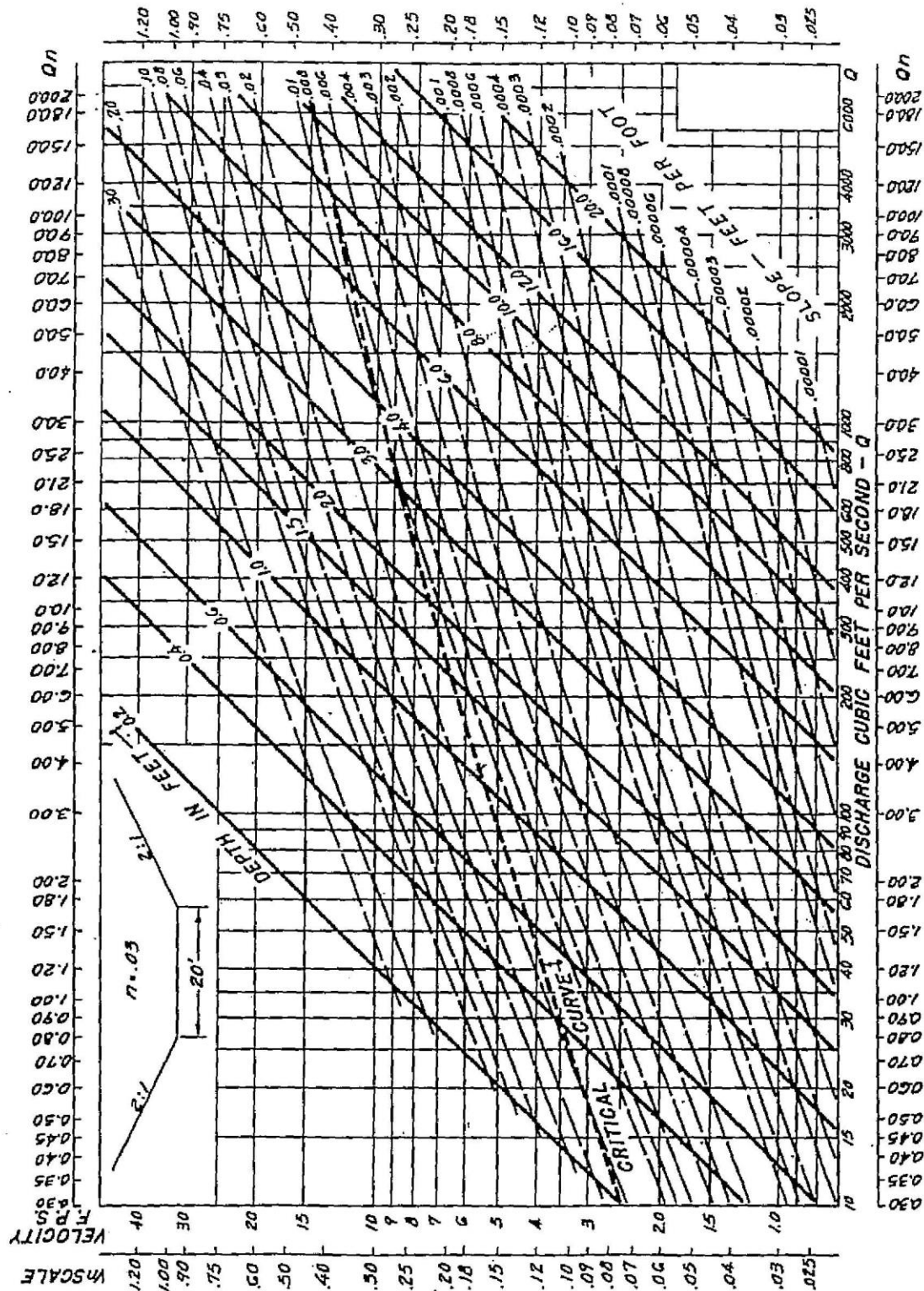

SOURCE:
City of
SPRINGDALE
Arkansas

CHANNEL CHART
2:1 b = 20 Ft.

Figure 9.36

TABLE OF CONTENTS - SECTION 10

SECTION 10 - EROSION AND SEDIMENT CONTROL

10.1 General

10.1.1 Requirement for Erosion Control

10.1.2. Permits Required

10.2 Erosion Control Methods

10.3 Siltation and Sediment Control

10.4 Control of Erosion for Swales, Open Channels, and Ditches

10.5 Design Standards of Erosion and Sediment Control Methods

10.5.1 Vegetation Practices

10.5.2 Mechanical Practices

10.5.3 Miscellaneous Practices

SECTION 10 - EROSION AND SEDIMENT CONTROL

10.1 GENERAL

10.1.1 Requirement for Erosion Control:

Erosion control measures shall be taken during construction to minimize the amount of silt and soil from entering adjacent streams and storm drainage facilities and to protect slopes and fill areas.

A copy of the erosion control plan, prepared by the Engineer of Record, shall accompany the construction drawing submittal. In addition, the City may require a copy of the Stormwater Pollution Prevention Plan (SWPPP), proof of Arkansas Department of Environmental Quality (ADEQ) approval of the SWPPP, and/or a copy of the Notice of Intent.

10.1.2 Permits Required:

All construction sites with a disturbed area of one acre or more are required by State law to have a Stormwater Pollution Prevention Plan. If the disturbed area exceeds certain limits, submission of the SWPPP to the Arkansas Department of Environmental Quality is required prior to commencement of construction activities. In addition, a Notice of Intent may be required to be filed with ADEQ.

The Developer and/or Contractor are solely responsible to obtain any and all permits required by this or other statutes, and to be fully informed of the requirements of County, State, and Federal regulations pertaining to construction activity.

10.2 EROSION CONTROL METHODS

Control of erosion during construction requires an examination of the entire site to pinpoint potential problem areas, such as steep slopes, highly erodible soils, soil areas that will be unprotected for long periods or during peak rainy seasons, and natural drainageways. Steps should be taken to assure erosion control in these critical areas. After a heavy storm, the effectiveness of erosion control measures should be evaluated. Periodic maintenance and cleaning of the facilities is also important.

Control of erosion after construction consists primarily of minimizing bottom and side scouring of the natural drainageways. This can be accomplished with a proper initial design that limits velocities and specifies correct drainageways linings and structures, and by proper routine maintenance and repair of the system.

Some of the basic concepts for controlling erosion during and after construction are as follows. This chapter is not intended to be a complete source of information concerning erosion control or best management practices. For a more thorough treatment of these issues, please refer to Field Manual on Sediment and Erosion Control Best Management Practices for Contractors and Inspectors, by Jerald S. Fifield, Ph.D., CPESC.

Earth Slopes: Erosion of cut or fill slopes is usually caused by water concentrations at the top of the slope flowing down an unprotected bank. Runoff should be diverted to safe outlets. Slopes should be protected from erosion by quick establishment of a vegetative cover, benches, terraces, slope protection structures, mulches, or a combination of these practices as appropriate.

Waterways or Channels: Waterways should be designed to avoid serious erosion problems. Wide channels with flat side slopes lined with grass or other vegetation will usually be free of erosion. Where channel gradients are steep, linings or grade control structures may be required. Space limitations may make it necessary to use concrete or stone linings. Every effort should be made to preserve natural channels.

Structures for Erosion Control: Erosion may be controlled through the use of grade control structures, energy dissipators, special culverts, and various types of pipe structures. Structures are expensive and should be used only after it has been determined that recommended vegetation, rock revetment, or other measures will not provide adequate erosion control.

Existing Vegetation: Good stands of existing vegetation adequate to control erosion should be preserved wherever possible.

Soil Treatment, Seeding, and Mulching: The ability of the soil to sustain vegetation intended for erosion control must be ascertained. The additional item of a mixture of fine-textured topsoil may be warranted to assure success of more attractive, lower maintenance vegetation. Liming and fertilization should be done according to recommendations based upon soil test information. After the soil has been prepared, the correct seed mixture, sod, ground cover, and mulch should be applied.

Outfall Design: The outfall pipe should be designed and located in a way that minimizes erosion, especially if the outfall flows to an overland flow area with a steep slope or is elevated above the base flow of the receiving streams. An energy dissipator may be necessary.

10.3 SILTATION AND SEDIMENT CONTROL

Proper control of soil erosion during and after construction is the most important element of siltation and sediment control. However, it is physically and economically impractical

to entirely eliminate soil erosion. Therefore, provisions should be made to trap eroded material at specified points. Some measures that can be implemented are as follows:

- Temporary ponds that store runoff and allow suspended solids to settle can be used during construction and may be retained as part of the permanent storage system after construction.
- Protection of inlets to the underground pipe system can be accomplished during and after construction by placing straw bales around the structure. Bales will remain or be replaced, if deteriorating, until lots are revegetated.
- Egress points from construction sites should be controlled so that the sediment is not carried offsite by construction traffic.

10.4 CONTROL OF EROSION FOR SWALES, OPEN CHANNELS, AND DITCHES

In designing channels for erosion control, the velocity must be estimated and compared to the allowable velocity for the material in which the water is flowing. Table 9.3 indicates the allowable velocities for grass channels. It should be noted that the quantity of water that can be carried in well established dense earth swales without erosion is surprisingly large, even for steep slopes. For urban residential drainageways, flow velocities for erosion- potential evaluation should be based upon the 10-year frequency runoff event, which generally is a practical break-point between initial costs and excessive maintenance costs.

Where the allowable velocity for a turf channel is exceeded, there are a number of alternatives to consider. They include: lining the channel with an impervious material; drop structures or other velocity and erosion control measures; gravel or riprap bottoms; and gabions (rock enclosed in wire baskets).

The probable performance of the open channels and swales should be evaluated for major storm runoff with respect to the depth and spread of water and erosion potential. Antecedent flow conditions resulting from previous storms are an important consideration. Open channels and swales may suffer damage during major storms, even if properly designed.

It is important that open channels be constructed in accordance with plans. When intermittent channels are sodded to the depth of the expected flow, they can immediately provide protection from minor storms. It may not be practical to establish turf in a drainage channel by seeding and mulching unless jute mats, or other similar protective materials, are placed over the seedbed.

10.5 DESIGN STANDARDS OF EROSION AND SEDIMENT CONTROL METHODS

The following is a discussion of design standards and definitions for different erosion and sediment control methods to be used on construction sites and similarly disturbed areas. These methods are presented to help establish uniformity in the selection, design, review, approval, installation, and maintenance of practices contained in erosion and sediment control plans.

These methods have similar functions but may differ in life span and degree of maintenance. These methods are defined as temporary and permanent erosion and sediment control measures.

Temporary measures are designed to have a short life, typically for the duration of the construction period. They may be used only for a matter of days or weeks. Because of their short life, they need not be designed to last for many years with minimum maintenance, nor need they be built of highly durable materials. Nonetheless, they must receive regular maintenance during their period of use to remain effective. Such measures may have a low initial cost but may have a relatively high maintenance cost if frequent or intense storms occur during the construction period.

Permanent measures are intended to remain in place for 50 years or more with minimum maintenance, so they may be designed and constructed of durable materials with life span in mind.

Generally, both temporary and permanent erosion and sediment control practices for disturbed areas caused by excavation or other construction activities fall into two broad categories-vegetative practices and mechanical practices. An overview of most of the practices is contained in the following discussion.

10.5.1 VEGETATION PRACTICES

Vegetation practices may be either temporary or permanent. They may be applied singularly or in combination with other practices. Cutting, filling, and grading soils with heavy equipment results in areas of exposed subsoils or mixtures of soil horizons. Conditions such as acidity, low fertility, compaction, and dryness or wetness often prevail and are unfavorable to plant growth. These conditions should be considered in the selection of plant growth type.

Excessive long slopes and steep grades are often encountered or created. Water disposal structures are normally subjected to hydraulic forces requiring both special establishment techniques and grasses that have high resistance to scouring. Plants and techniques, however, are available to provide both temporary and permanent protective cover on these difficult sites.

1. Temporary Vegetation

Earth moving activities such as heavy cutting, filling, and grading are generally performed in several stages and are often interrupted by lengthy periods, during which the land lies idle and is subject to accelerated erosion. In addition, final land grading may be completed during a season not favorable for immediate establishment of permanent vegetation. These and similar sites can be temporarily stabilized by establishment of rapid growing annual grasses. This type of vegetation provides quick protective cover and can later be worked into the soil for use as mulch when the site is prepared for establishment of permanent vegetation.

2. Permanent Vegetation

When areas are to be vegetated permanently, special care should be taken in selecting the plants to be used. There is a fairly wide selection of grasses, legumes, ground covers, shrubs, and trees from which to choose. If a high level of management can be provided, the range of plants that can be used is broader. Final selection should be based on adaptation of the plants to the soils and climate, suitability for their specific use, ease of establishment, longevity or ability to reseed, maintenance requirements, aesthetics, and other special qualities.

Plans that provide long-lived stabilization with the minimum amount of required maintenance should be selected. Where management potential is limited because of specialized circumstances, the best plants to choose are those that are well adapted to the site and to the specific purpose for which they are to be used. For example, grasses used for waterway stabilization must be able to withstand submergence and provide a dense cover to prevent scouring of the channel boundary.

In playgrounds, grasses must lend themselves to close grooming and be able to withstand heavy trampling. In some places, such as southern-exposed cut-and-fill slopes, the plants must be adapted to full sunlight and drought conditions. In other places, plants must be able to tolerate shade or high moisture conditions. Some plants can be used for beautification as well as for soil stabilization.

Maintenance must be the most important consideration in selecting plants for permanent stabilization.

Most domestic grasses and legumes require a high level of maintenance, or they will not survive and will gradually give way to hardier native grasses, legumes, and shrubs. In some areas, native plants are preferred. On steep slopes and other inaccessible areas, it is preferable to select plants requiring little or no maintenance. Crown vetch, honeysuckle, and sericea lespedeza are examples of long-lived species that provide good erosion control with a minimum of maintenance. Most native grasses, trees, and shrubs grow well with little or no maintenance.

3. Mulching

When final grading has not been completed, straw, wood chips, asphalt emulsion, jute matting, or similar materials can be applied to provide temporary protection. Areas brought to final grade during midsummer or winter can be mulched immediately and over-seeded at the proper season with a number of permanent grasses or legume species. Application of mulch to disturbed areas allows for more infiltration of water into the soil; reduces runoff; holds seed, fertilizer, and lime in place; retains soil moisture; helps maintain temperatures conducive to germination; and greatly retards erosion. Mulch is essential in establishing good stands of grasses and legumes in disturbed areas. It is important to anchor mulch to prevent it from blowing or washing off the site.

10.5.2 MECHANICAL PRACTICES

Where mulches and vegetated cover will not provide adequate protection against erosion and sediment damages, other erosion and sediment control measures will be needed. A number of mechanical practices can be used to curb erosion and sedimentation during construction. These practices must be selected in the proper combination, carefully designed, and constructed to accomplish the most effective job. The design of all mechanical practices must be based on the maximum storm runoff that will result from a 25-year-frequency storm and must consider the maximum storm runoff that will result from the 100-year-frequency storm if public health and safety are effected. Figures 10.1 through 10.6 illustrate commonly used mechanical erosion and sediment control practices. The following are some of the conservation structures appropriate for use on excavation and construction sites and similar disturbed areas:

1. Temporary Construction Entrance

This structure is a stone stabilized pad constructed at points where traffic will be entering or leaving a construction site from or to public right-of-way, street, alley, sidewalk, or parking area. Its purpose is to reduce or eliminate the transport of mud from the construction area onto the public right-of-way by motor vehicles or by runoff.

2. Diversion Dike

This is a compacted earthen ridge constructed immediately above a cut or fill slope. Its purpose is to intercept storm runoff from upstream soil drainage areas and divert the water away from the exposed slope to a stabilized outlet.

3. Perimeter Dike

This is a compacted earthen dike constructed along the perimeter of a disturbed area to divert sediment-laden stormwater to onsite trapping facilities. It is maintained until the disturbed area is permanently stabilized.

4. Interceptor Dike

This is a temporary ridge of compacted soil or, preferably, gravel constructed across disturbed rights-of-way. An interceptor dike reduces erosion by intercepting stormwater and diverting it to stabilized outlets.

5. Straw Bale Barrier

This is a temporary barrier constructed across or at the toe of the slope. Its purpose is to intercept and detain sediment from areas one-half acre or smaller where only sheet erosion may be a problem.

6. Gravel Outlet Structure

This is an auxiliary structure installed in combination with and as a part of a diversion, interceptor, or perimeter dike, or other structures designed to temporarily detain sediment-laden stormwater. The gravel outlet provides a means of draining off and filtering the stormwater while retaining the sediment behind the structure.

7. Level Spreader

This is a temporary structure that is constructed at zero grade across the slope where concentrated runoff may be intercepted and diverted onto a stabilized outlet. The concentrated flow or stormwater is converted to sheet flow at the outlet.

8. Waterways or Outlets

Waterways may serve as outlets for diversion, berms, terraces, or other structures.

They may be natural or constructed, shaped to the required dimension, and vegetated or paved for runoff water. Usually they are constructed to one of three general cross sections: parabolic, trapezoidal, or V-shaped. Where they are to be vegetated, parabolic waterways are the most commonly used. Successful function of a waterway depends on protection from erosion. This is achieved either by designing for flow velocities that are nonerosive for the vegetation used or by paving with concrete or rock.

9. Diversions

These are designed, graded channels with a supporting ridge on the lower side constructed across the slope. Their purpose is to intercept surface water. Diversion structures may be temporary or permanent and graded or level. They are useful above cut slopes, borrow areas, gully heads, and similar areas. They can be constructed across cut slopes to reduce slope plains into nonerosive segments and can be used to move runoff water away from critical construction sites. They may be used at the base of cut or fill slopes to carry sediment-laden flow to traps or basins. Divisions should be located so that the water will empty into established disposal areas, natural outlets, or prepared individual outlets. Individual outlets can be designed as grass or paved waterways, chutes, or buried pipes.

10. Grade Stabilization Structures

Grade stabilization structures can be constructed from such materials as earth, pipe, masonry concrete, steel, aluminum, wood, or a combination of these. Grade stabilization structures are used to safely convey water from one level to a lower level without damage, to reduce grade in a watercourse, to stabilize head cutting of watercourses, or to change the direction of flow of water. They can consist of straight drop spillways, box inlet drop spillways, drop box culverts, chutes, pipe drop inlets, or bond inlets. An earthen embankment is usually incorporated as part of this structure.

11. Sediment Basins

Sediment basins can be used to trap runoff waters and sediment from disturbed areas. The water is temporarily detained to allow sediment to drop out and be retained in the basin while the water is automatically released.

Sediment basins usually consist of a dam or embankment, a pipe outlet, and an emergency spillway. They are usually situated in natural drainageways or at the low corner of the site. In situations where embankments may not be feasible, a basin excavated below the earth's surface may serve the same purpose. A special provision, however, must be made for draining such an impoundment.

Sediment basins may be temporary or permanent. Temporary ones serve only during the construction stage and are eliminated when vegetation is established and the area is stabilized. Permanent structures are designed to fit into the overall plan for the permanent installation. The size of the structure will depend upon the location, size of drainage area, soil type, and rainfall pattern. Significant space for sediment should be provided to store the expected sediment from the drainage area for the planned life of the structure, or provisions should be made for periodic cleanout of sediment from the basin. State and local safety regulations must be observed regarding design, warning signs, and fencing of these structures.

12. Sediment Trap

A sediment trap is a structure of limited capacity designed to create a temporary pond around storm drain inlets or at points

where silt-laden stormwater is discharged. It is used to trap sediment on construction sites, prevent storm drains from being blocked, and prevent sediment pollution of watercourses.

13. Land Grading

Grading should be held to a minimum level that makes the site suitable for its intended purpose without appreciably increasing runoff. Grading only those areas required for immediate construction, as opposed to grading the entire site, greatly helps in controlling erosion. Large tracts should be graded in units of workable size within construction phases so that the first unit is stabilized before the next unit is opened up. This technique helps minimize the area and duration that the bare land is exposed to erosion.

14. Storm Drain Outlet Protection

This practice involves putting paving or riprap on channel sections immediately below storm drain outlets. A storm drain outlet is designed to reduce the velocity of flow and prevent downstream channel erosion. It is also known as an energy dissipator.

15. Riprap

This is a layer of rock placed over the soil surface to prevent erosion by service flow or wave action. Riprap may be used, as appropriate, as storm drain outlets, channel bank and bottom protection, roadside ditches protection, drop structures, etc.

16. Subsurface Drains

Subsurface drains used to remove excess groundwater are sometimes required at the base of fill slopes or around building foundations. When heavy grading is done and natural water channels are filled, the subsurface drains may be used to prevent accumulation of groundwater. Subsurface drains may be needed in vegetated channels to lower a high water table and to improve drainage conditions so vegetation can be established and maintained.

17. Flexible Down Drain

This is a temporary structure used to convey stormwater from one elevation to another without causing erosion. It is made of heavy-

duty fabric or other material that can be removed when the permanent water disposal system is installed.

18. Silt Fence

Silt fence barriers are constructed of a geosynthetic material attached (usually by staples) to wooden or metal posts to form a barrier “fence” surrounding construction areas. Silt fences must be placed at or beyond the toe of slopes in order to be effective in catching sediments from slopes. Silt fences do not generally act as filters, but cause sediments to drop out of stormwater by impounding the runoff, creating a temporary stilling pond behind the silt fence. Due to their nature and mechanism, silt fences must be installed with the bottom edge entrenched into the ground to be effective, and must be rigorously maintained at all times.

10.5.3 MISCELLANEOUS PRACTICES

Some other conservation practices should be observed during excavation and construction to increase the effectiveness of erosion and sediment control measures:

1. Locate storage and shop yards where erosion and sediment hazards are slight. If this is not feasible, apply necessary paving and erosion control practices.
2. Saturate ground or apply dust suppressors. Keeping dust down to tolerable limits on the construction site and haul roads is very important.
3. Use temporary bridges with culverts where fording of streams is objectionable. Avoid borrow areas where pollution from this operation is inevitable.
4. Protect streams from chemicals, fuels, lubricants, sewage, or other pollutants.
5. Avoid disposal of fill in floodplains or drainageways.